

Model

Designation	HMK12AA	220-240V/50Hz 1~	Sales code:	CDO00163
-------------	----------------	------------------	-------------	-----------------

Compressor design

Oil type	Mineral	Refrigerant(s)	R600a
Oil viscosity	4,6cST	Displacement	11,2cm ³ / 0,68cu.in
Oil quantity	162cm ³ / 5,5fl.oz	Compressors on pallet	100
Refr. charge - tech. limit	150g / 5,3oz		
Free gas volume comp.	1600cm ³ / 54,1fl.oz		
Weight	9kg / 19,8lbs		
Motor protection	external		
Winding resistance main	15,7Ω (at 25°C)		
Winding resistance aux	12,6Ω (at 25°C)		
Max. winding temp.	130°C / 266°F		
Max. discharge temp.	120°C / 248°F		



General - Configurations with HMK12AA

	Conf. 1
Motorconfiguration	RSIR
Power supply (nominal)	220-240V/50Hz
Number of phases	1
Voltage range	187-264V
Approvals	VDE
Starting torque	LST
Note	- / -

Applications with HMK12AA

	Conf. 1
Refrigerant	R600a
Application	LBP
System cooling	static
Hot gas defrost	- / -
Long interval pull down	- / -

Electrical data - Configurations with HMK12AA

	Conf. 1
Starting device type	PTC
Run capacitor	- / -
Start capacitor	- / -
LRA (locked rotor amps / 4s)	6,2A
RLA (rated load amps / 1s)	1,2A
Cut in current	12,9A

Model

Designation

HMK12AA

220-240V/50Hz 1~

Sales code:

CDO00163

Compressor dimensions

Housing	A Height	174mm / 6,85in
	B Height	167mm / 6,57in
	C Length shell	194mm / 7,64in
	D Length w. cover	238mm / 9,37in
	E Width	151mm / 5,94in

Connectors		Suction	Discharge	Process
		X	Y	Z
Diameter	[mm]	øi 6,1-6,2	øi 5,1-5,2	øo 5,92-6,08
(i:inside, o:outside)	[in]	øi 0,24-0,24	øi 0,2-0,2	øo 0,23-0,24
Material		copper	copper	copper
Horizontal angle	±2°	45°	13°	0°
Vertical angle	±2°	30°	40°	145°
Position l/h/w	[mm]	120/72/62	112/106/62	-140/136/70
	[in]	4,7/2,8/2,4	4,4/4,2/2,4	-5,5/5,4/2,8
Straight tube l.	[mm]	14	14	75
	[in]	0,5	0,5	3

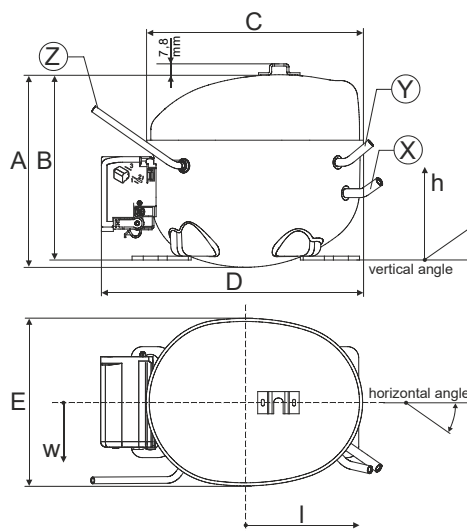

Compressor fixation

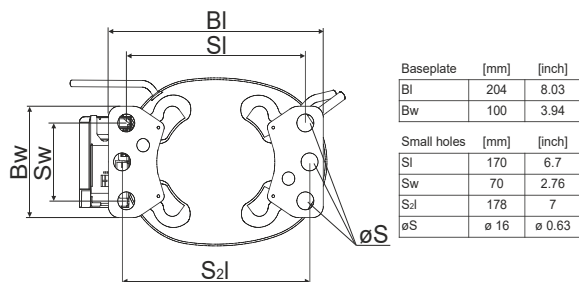

Bolt joint

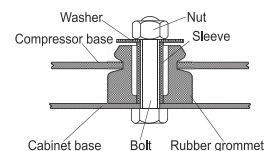

Snap-on

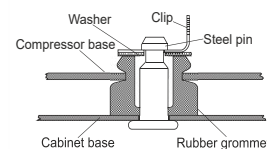

Mounting accessories

'4ZN' with rubber grommet

'4ZN' with rubber grommet and sleeve for M6

Bolt joint kit

'4ZN' with Snap on kit

order code

772N

768N

4ZN + 118-1917 (18)

776N

Application notes

Various options of housing are possible (dip-tray fixture) - please contact SECOP-Sales.

Various options of connectors are possible - please contact SECOP-Sales.

Provision for PE Grounding is located at the PE Stamp on the compressor

Model

Designation	HMK12AA	220-240V/50Hz	Conf. 1	Sales code:	CDO00163
-------------	----------------	----------------------	----------------	-------------	-----------------

Configuration

Motorconfiguration	RSIR
Power supply (nominal)	220-240V/50Hz 1~
Refrigerant	R600a
Application	LBP
Voltage range	187-264V
Starting torque	LST
Approvals	VDE

Electrical accessories / wiring diagram

RSIR

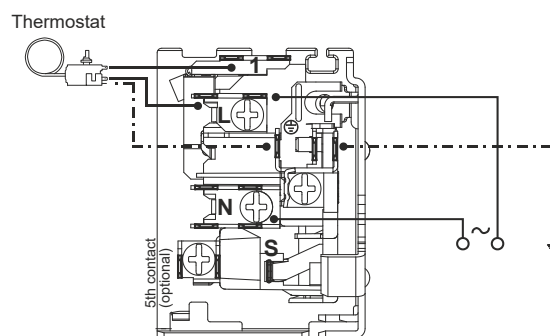
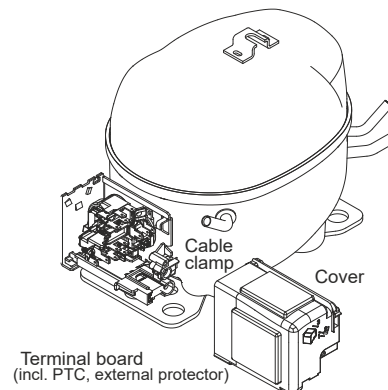

Ambient/ machine room temperatures minimum /maximum

Ambient temperature range: 10 - 43°C / 50 - 110°F

Machine room temperature range: 10 - 48°C / 50 - 119°F

Compressor cooling: static

Operation Limits

Operation pressure range

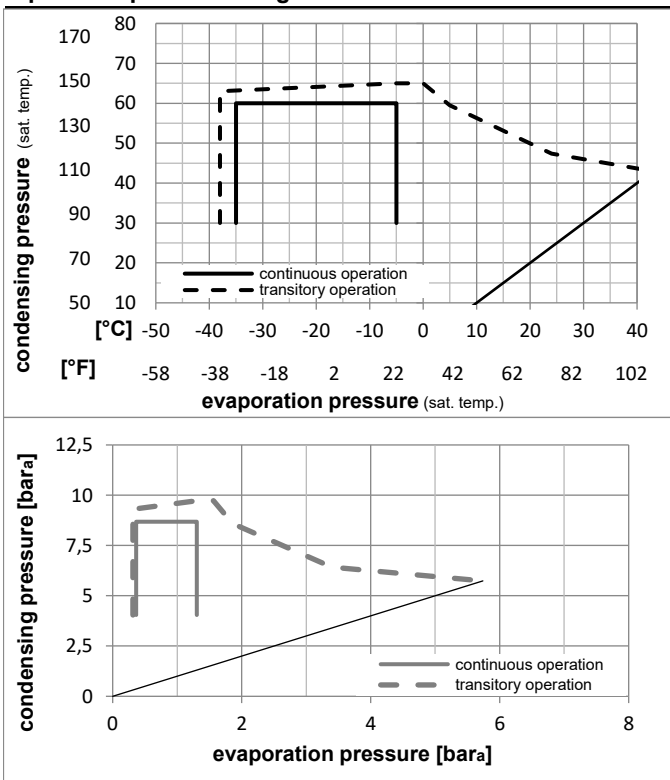

Components

terminal board (PTC,4.8mm,K100)	ZA FP
motor protector BDG AE 72 FU x	AE72FUX
cover + clamp + screws (Nr. 4ZN)	16168000
evaporation tray (optional)	113188_

Alternative components

terminal board (PTC,6.3mm,K100)	DA FP
motor protector BDG AE 72 FU x	AE72FUX
cable clamp (screws not included)	113410_
cover	157595_
evaporation tray (optional)	113188_

Model

Designation **HMK12AA** **220-240V/50Hz** Conf. 1 Sales code: **CDO00163**

Optimization + standard conditions

R600a, 220V/50Hz, RSIR, static, VDE

		Evaporating pressure (saturation temperature)				Condensing pressure (saturation temperature)			Return gas temp.			Liquid temp.			Cooling capacity			COP	EER	Power consumption			
		pe	pc	RGT	Tliq	[W]	[Btu/h]	[kcal/h]	[W/W]	[Btu/Wh]	[kcal/Wh]	P1	I	m	[W]	[A]	[kg/h]						
[°C]	[°F]																						
-23	54	32	32	197,9	676	170,4	1,53	5,23	1,32	129,2	0,87	2,12	ASHRAE LBP										
-10	130	90	90																				
-25	55	32	55	149,0	509	128,2	1,20	4,10	1,03	124,0	0,85	1,94	cecomaf LBP										
-13	131	90	131																				
-35	40	20	40	93,7	320	80,6	1,08	3,68	0,93	87,0	0,72	1,14	EN12900 LBP										
-31	104	68	104																				
-23	49	4,4	49	160,7	549	138,3	1,28	4,37	1,10	125,5	0,86	2,35	ARI540 LBP										
-10	120	40	120																				
-23	41	32	32	211,6	723	182,1	1,75	5,99	1,51	120,7	0,84	2,27	AHAM LBP										
-10	105	90	90																				
-35	45	32	45	91,7	313	78,9	1,04	3,54	0,89	88,5	0,71	1,09	opt										
-31	113	90	113																				

Performance tables

R600a, 220V/50Hz, RSIR, static, VDE

	pe		Cooling capacity			COP	EER	P1	I	m	
	[°C]	[°F]	[W]	[Btu/h]	[kcal/h]	[W/W]	[Btu/Wh]	[kcal/Wh]	[W]	[A]	[kg/h]
[°C / °F]	-35	-31	91,7	313	78,9	1,04	3,54	0,89	88,5	0,71	1,09
cond. pressure	-30	-22	129,3	442	111,3	1,25	4,26	1,07	103,8	0,77	1,54
pc= 45/113	-25	-13	171,7	586	147,8	1,45	4,95	1,25	118,4	0,83	2,04
return gas temp.	-23	-10	187,2	639	161,1	1,52	5,19	1,31	123,3	0,85	2,23
RGT= 32/90	-20	-4	218,8	747	188,3	1,65	5,64	1,42	132,4	0,89	2,61
liquid temp	-15	5	270,5	924	232,8	1,86	6,34	1,60	145,8	0,96	3,23
Tliq= 45/113	-5	23	387,4	1323	333,4	2,27	7,75	1,95	170,7	1,10	4,65
[°C / °F]	-35	-31	81,6	279	70,2	0,90	3,07	0,77	90,8	0,69	1,06
cond. pressure	-30	-22	112,5	384	96,8	1,05	3,58	0,90	107,3	0,76	1,47
pc= 55/131	-25	-13	149,0	509	128,2	1,20	4,10	1,03	124,0	0,85	1,94
return gas temp	-23	-10	162,7	556	140,0	1,25	4,28	1,08	129,8	0,87	2,12
RGT= 32/90	-20	-4	191,0	652	164,4	1,35	4,62	1,16	141,1	0,93	2,50
liquid temp	-15	5	238,4	814	205,1	1,50	5,13	1,29	158,6	1,01	3,12
Tliq= 55/131	-5	23	349,2	1193	300,5	1,79	6,12	1,54	194,9	1,18	4,60