

## Single Pack SCE21CNLX 208-230V 60Hz CSIR

Single pack code number: **195B4362**

Position	Title	Code	Amount
1	Compressor SCE21CNLX	104H8174	1
2	Starting capacitor (60 $\mu$ F 260V, 6.3mm)	117U5076	1
3	Snap-on in quantities   $\varnothing$ 7,3   $\varnothing$ 16mm	118-1919	1

**Secop GmbH** • Lise-Meitner-Straße 29 • 24941 Flensburg, Germany • Tel: +49 461 4941 0 • [www.secop.com](http://www.secop.com)

Secop accepts no responsibility for possible errors in catalogs, brochures, and other printed material. Secop reserves the right to alter its products without notice. This also applies to products already on order provided that such alterations can be made without subsequent changes being necessary to specifications already agreed. All trademarks in this material are the property of the respective companies. Secop and the Secop logotype are trademarks of Secop GmbH. All rights reserved.

## Model

Designation	<b>SCE21CNLX</b>	208-230V/60Hz 1~	Sales code:	<b>104H8174</b>
-------------	------------------	------------------	-------------	-----------------

## Compressor design

Oil type	Polyolester	Refrigerant(s)	<b>R290</b>
Oil viscosity	32cSt	Displacement	20,95cm <sup>3</sup> / 1,28cu.in
Oil quantity	550cm <sup>3</sup> / 18,6fl.oz	Compressors on pallet	80
Refr. charge - tech. limit	550g / 19,4oz		
Free gas volume comp.	1460cm <sup>3</sup> / 49,4fl.oz		
Weight	14,2kg / 31,3lbs		
Motor protection	external		
Winding resistance main	2,7Ω (at 25°C)		
Winding resistance aux	18,7Ω (at 25°C)		
Max. winding temp.	125°C / 257°F		
Max. discharge temp.	140°C / 284°F		



## General - Configurations with SCE21CNLX

	<b>Conf. 1</b>
Motorconfiguration	CSIR
Power supply (nominal)	208-230V/60Hz
Number of phases	1
Voltage range	198-253V
Approvals	UL, KC, CB
Starting torque	HST
Note	Protector, relay and cover are included and pre-assembled to compressor.

## Applications with SCE21CNLX

	<b>Conf. 1</b>
Refrigerant	R290
Application	LBP
System cooling	fan 3m/s
Hot gas defrost	OK
Long interval pull down	-/-

## Electrical data - Configurations with SCE21CNLX

	<b>Conf. 1</b>
Starting device type	relay
Run capacitor	-/-
Start capacitor	60μF
LRA (locked rotor amps / 4s/ U(N))	25,9A
RLA (rated load amps / 1s/ U(N))	5A
Cut in current (U(N))	25,9A

## Model

Designation

**SCE21CNLX**

208-230V/60Hz 1~

Sales code:

**104H8174**

## Compressor dimensions

Housing	A Height	219mm / 8,62in
	B Height	213mm / 8,39in
	C Length shell	218mm / 8,58in
	D Length w. cover	255mm / 10,04in
	E Width	151mm / 5,94in

Connectors		Suction	Discharge	Process
		X	Y	Z
Diameter	[mm]	øi 9,54-9,72	øi 6,41-6,59	øi 6,41-6,59
(i:inside, o:outside)	[in]	øi 0,38-0,38	øi 0,25-0,26	øi 0,25-0,26
Material		copper	copper	copper
Horizontal angle	±2°	37°	37°	143°
Vertical angle	±2°	30°	0°	150°
Position l/h/w	[mm]	107/193/55	115/110/63	-107/193/55
	[in]	4,2/7,6/2,2	4,5/4,3/2,5	-4,2/7,6/2,2
Straight tube l.	[mm]	12	12	12
	[in]	0,5	0,5	0,5



## Compressor fixation



## Bolt joint

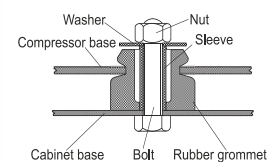

## Snap-on

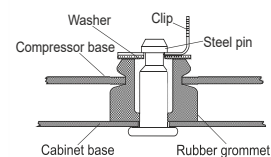

## Mounting accessories

Mounting accessories	one comp.	multi pack
Bolt joint   M6   ø16mm	118-1917	118-1918
Bolt joint   ø1/4"   ø16mm	118-1946	
Bolt joint   ø1/4"   ø19mm	118-1949	
Snap-on   ø7,3   ø16mm	118-1947	118-1919

## Application notes

Provision for PE Grounding is located at the PE Stamp on the compressor

## Model

Designation **SCE21CNLX** **208-230V/60Hz** Conf. 1 Sales code: **104H8174**

## Configuration

Motor configuration CSIR  
 Power supply (nominal) 208-230V/60Hz 1~  
 Refrigerant R290  
 Application LBP  
 Voltage range 198-253V  
 Starting torque HST  
 Approvals UL  
 KC  
 CB

## Electrical accessories / wiring diagram

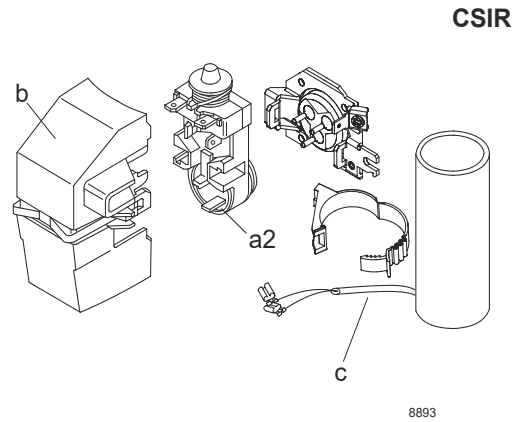

## Ambient/ machine room temperatures minimum /maximum

Ambient temperature range: 10 - 38°C / 50 - 101°F

Machine room temperature range: 10 - 43°C / 50 - 110°F

Compressor cooling: fan 3m/s

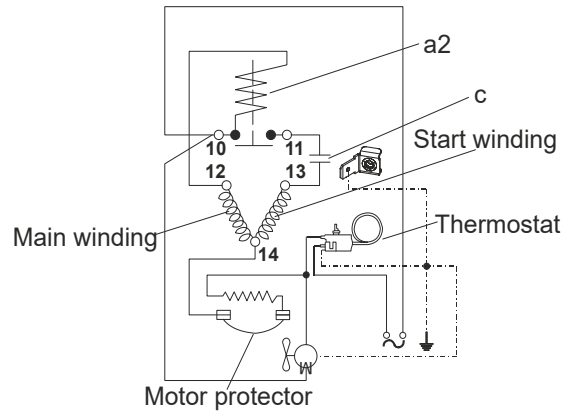

## Operation pressure range

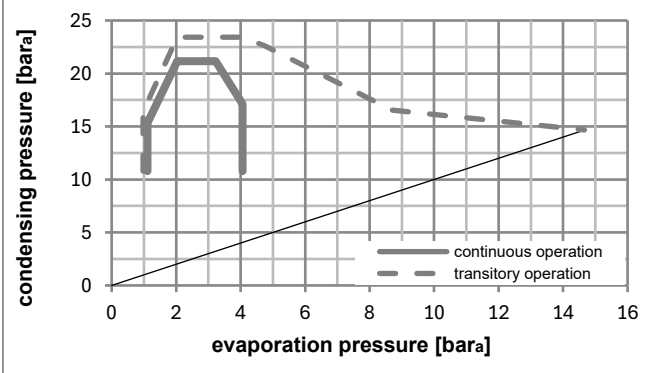
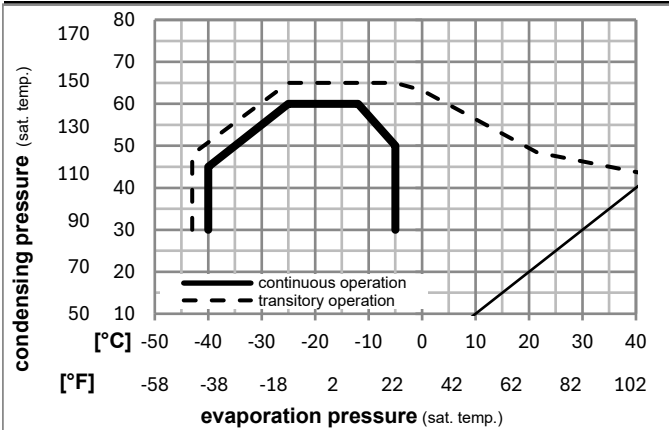

## Components (relay (a2)+ cover (b): pre-assembled)

a2	assy. relay + ext. protector (T1141)	117U7407
c	start capacitor (60μF, 6.3mm, 82kOhm)	117U5076
b	plastic cover + clamp	117U1021

## Noise emission

Operation pressures:	pe: -25°C / -13°F
	pc: 45°C / 113°F
Motor speed appr.:	3500rpm
Lw(A):	58dB(A)

### Model

Designation **SCE21CNLX** **208-230V/60Hz** Conf. 1 Sales code: **104H8174**

### Optimization + standard conditions

R290, 230V/60Hz, CSIR, fan 3m/s, UL, KC, CB

		Evaporating pressure (saturation temperature)				Condensing pressure (saturation temperature)			Return gas temp.		Liquid temp.		Cooling capacity			COP	EER	Power consumption		
		pe	pc	RGT	Tliq	[W]	[Btu/h]	[kcal/h]	[W/W]	[Btu/Wh]	[kcal/Wh]	P1	I	Current consumption		Ref. mass flow				
[°C]	[°F]	[°C]	[°F]	[°C]	[°F]							[W]	[A]	[A]	[A]	[kg/h]	ASHRAE LBP			
-23	-10	54	130	32	90	1075,7	3674	925,7	1,52	5,18	1,31	708,7	4,11	10,89						
-25	-13	55	131	32	90	792,0	2705	681,6	1,18	4,03	1,01	671,6	4,00	9,86						
-35	-31	40	104	20	68	614,3	2098	528,7	1,20	4,10	1,03	511,9	3,53	7,02						
-23	-10	49	120	4,4	40	909,5	3106	782,7	1,27	4,35	1,10	714,4	4,10	12,60						
-23	-10	41	105	32	90	1246,7	4258	1073,0	1,77	6,04	1,52	705,0	4,10	12,63						
-35	-31	45	113	32	90	567,2	1937	488,1	1,13	3,85	0,97	502,9	3,49	6,36					opt	

### Performance tables

R290, 230V/60Hz, CSIR, fan 3m/s, UL, KC, CB

	pe		Cooling capacity			COP	EER	P1	I	m	
	[°C]	[°F]	[W]	[Btu/h]	[kcal/h]	[W/W]	[Btu/Wh]	[kcal/Wh]	[W]	[A]	[kg/h]
[°C / °F]	-40	-40	401,4	1371	345,4	0,98	3,33	0,84	411,6	3,30	4,49
cond. pressure	-34	-30	587,5	2007	505,6	1,15	3,91	0,99	513,1	3,52	6,59
pc= 45/113	-29	-20	813,1	2777	699,7	1,32	4,52	1,14	614,6	3,79	9,14
return gas temp.	-23	-10	1082,6	3697	931,7	1,52	5,18	1,31	713,3	4,11	12,23
RGT= 32/90	-21	-5	1235,3	4219	1063,1	1,62	5,55	1,40	760,7	4,27	13,98
liquid temp	-15	5	1579,2	5393	1359,1	1,86	6,35	1,60	849,6	4,59	17,97
Tliq= 45/113	-5	23	2341,0	7995	2014,7	2,38	8,14	2,05	982,4	5,13	26,95
[°C / °F]	-40	-40	259,3	885	223,1	0,73	2,50	0,63	354,6	3,23	3,20
cond. pressure	-34	-30	428,8	1464	369,0	0,92	3,13	0,79	468,6	3,44	5,30
pc= 55/131	-29	-20	629,9	2151	542,1	1,07	3,66	0,92	587,3	3,74	7,82
return gas temp	-23	-10	867,2	2962	746,3	1,23	4,18	1,05	707,8	4,11	10,81
RGT= 32/90	-21	-5	1000,9	3418	861,3	1,30	4,45	1,12	767,8	4,32	12,51
liquid temp	-15	5	1301,0	4443	1119,6	1,47	5,02	1,26	885,6	4,75	16,36
Tliq= 55/131	-5	23	1964,1	6708	1690,3	1,82	6,20	1,56	1081,9	5,55	25,02



# SCE Compressors

## (External Protector)

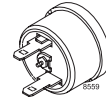

	S	C	R
ENGLISH	Black	Brown	Blue or grey
DEUTSCH	Schwarz	Braun	Blau od. grau
FRANÇAIS	Noir	Marron	Bleu ou gris
ESPAÑOL	Negro	Marrón	Azul o gris
ITALIANO	Nero	Marrone	Blu o grigio
NEDERLANDS	Zwart	Bruin	Blauw of grijs
РУССКИЙ	Чёрный	Коричневый	Синий или серый
中文	黑色	棕色	蓝色或灰色

	S	C	R
ENGLISH	Black	Brown	Blue or grey
DEUTSCH	Schwarz	Braun	Blau od. grau
FRANÇAIS	Noir	Marron	Bleu ou gris
ESPAÑOL	Negro	Marrón	Azul o gris
ITALIANO	Nero	Marrone	Blu o grigio
NEDERLANDS	Zwart	Bruin	Blauw of grijs
РУССКИЙ	Чёрный	Коричневый	Синий или серый
中文	黑色	棕色	蓝色或灰色



# SCE Compressors (External Protector)



## Service/Repair – R290



8545

## Brazing on Suction Connectors (Direct Intake)



**! max. 350°C/662°F !**  
**at socket**  
brazing solder: phosphor (LP7) or silver

8882

Refer to Product Bulletin:  
**Brazing on Suction Connectors**  
**(SCE Compressors with Direct Suction Intake)**

Secop accepts no responsibility for possible errors in catalogs, brochures, and other printed material. Secop reserves the right to alter its products without notice. This also applies to products already on order provided that such alterations can be made without subsequential changes being necessary to specifications already agreed. All trademarks in this material are the property of the respective companies. Secop and the Secop logotype are trademarks of Secop GmbH. All rights reserved. [www.secop.com](http://www.secop.com)