

Single Pack SC12CLX.2 208-230V 60Hz CSCR

Single pack code number: **195B4418**

Position	Title	Code	Amount
1	Compressor SC12CLX.2	104L2699	1
2	SC starting device (550mm)	117-7027	1
3	Cord relief	103N1004	1
4	Cover	103N2008	1
5	Bolt joint for one compressor M6 ø16mm	118-1917	1

Secop GmbH • Lise-Meitner-Straße 29 • 24941 Flensburg, Germany • Tel: +49 461 4941 0 • www.secop.com

Secop accepts no responsibility for possible errors in catalogs, brochures, and other printed material. Secop reserves the right to alter its products without notice. This also applies to products already on order provided that such alterations can be made without subsequent changes being necessary to specifications already agreed. All trademarks in this material are the property of the respective companies. Secop and the Secop logotype are trademarks of Secop GmbH. All rights reserved.

SC12CLX.2 LBP Compressor R404A/R507 208-230V 60Hz

General

Code number	104L2699
Approvals	UL984, KC
Compressors on pallet	80

Application

Application	LBP			
	Hz	50	60	
Frequency	Hz	50	60	
Evaporating temperature	°C	-	-45 to -10	
Voltage range	V	-	187 - 254	
Max. condensing temperature continuous (short)	°C	-	55 (60)	
Max. winding temperature continuous (short)	°C	-	125 (135)	

Cooling requirements

Frequency	Hz	50			60		
		LBP	MBP	HBP	LBP	MBP	HBP
32°C		-	-	-	F ₂	-	-
38°C		-	-	-	F ₂	-	-
43°C		-	-	-	F ₂	-	-
Remarks on application:							

Motor

Motor type	CSR		
LRA (rated after 4 sec. UL984), HST LST	A	19.6	-
Cut in Current, HST LST	A	19.6	-
Resistance, main start winding (25°C)	Ω	3.8	13.7

Design

Displacement	cm ³	12.87
Oil quantity (type)	cm ³	500 (polyolester)
Maximum refrigerant charge	g	1300
Free gas volume in compressor	cm ³	1510
Weight without electrical equipment	kg	13.7

Dimensions

Height	mm	A	219
		B	213
		B1	193
		B2	110
Suction connector	location/I.D. mm angle	C	9.7 37°
	material comment	Copper Rubber plug	
Process connector	location/I.D. mm angle	D	6.5 37°
	material comment	Copper Rubber plug	
Discharge connector	location/I.D. mm angle	E	6.5 37°
	material comment	Copper Rubber plug	
Oil cooler connector	location/I.D. mm angle	F	-
	material comment	-	
Connector tolerance	I.D. mm		±0.09
Remarks:			

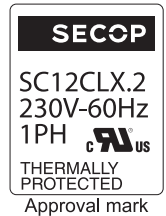
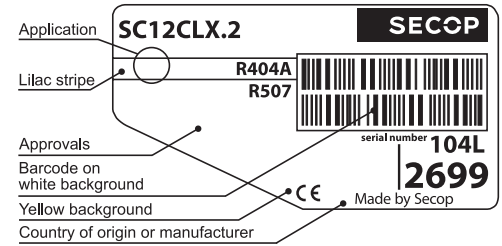

- S = Static cooling normally sufficient
- O = Oil cooling
- F₁ = Fan cooling 1.5 m/s (compressor compartment temperature equal to ambient temperature)
- F₂ = Fan cooling 3.0 m/s necessary
- SG = Suction gas cooling normally sufficient
- = not applicable in this area

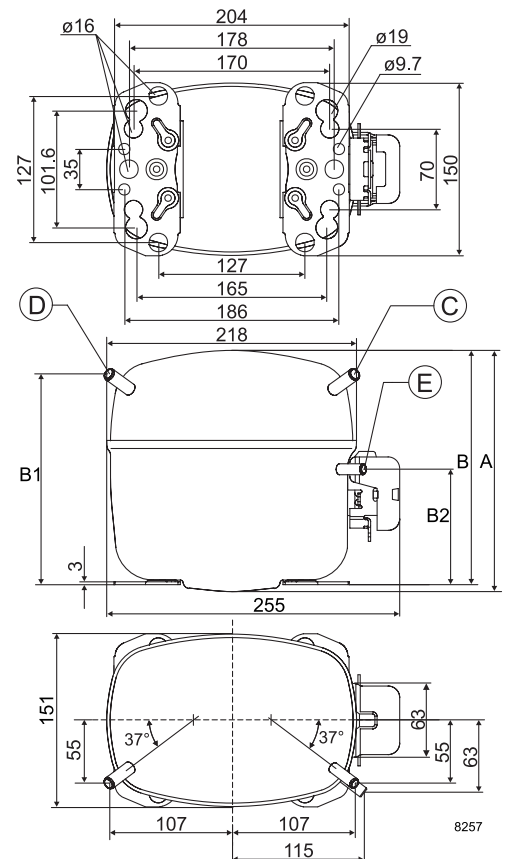

EN 12900 Household (CECOMAF)* 230V, 60Hz, fan cooling F₂

Evap. temp. in °C	-45	-40	-35	-30	-25	-23.3	-20	-15	-10	-6.7	-5	0	5	7.2	10	15	20
Capacity in W	141	233	343	473	626	683	804	1011	1248								
Power cons. in W	286	344	401	457	515	535	575	638	705								
Current cons. in A	1.70	1.81	1.93	2.07	2.24	2.30	2.42	2.62	2.83								
COP in W/W	0.49	0.68	0.86	1.03	1.21	1.28	1.40	1.58	1.77								

ASHRAE LBP 230V, 60Hz, fan cooling F₂

Evap. temp. in °C	-45	-40	-35	-30	-25	-23.3	-20	-15	-10	-6.7	-5	0	5	7.2	10	15	20
Capacity in W	82	190	317	465	640	706	845	1084	1361								
Power cons. in W	264	334	401	468	534	557	602	671	744								
Current cons. in A	1.57	1.71	1.86	2.04	2.23	2.30	2.44	2.67	2.91								
COP in W/W	0.31	0.57	0.79	1.00	1.20	1.27	1.41	1.62	1.83								

ASHRAE LBP* 230V, 60Hz, fan cooling F₂

Evap. temp. in °C	-45	-40	-35	-30	-25	-23.3	-20	-15	-10	-6.7	-5	0	5	7.2	10	15	20
Capacity in W	176	283	426	598	739	805	1051	1339	1467								
Power cons. in W	289	345	406	468	512	531	598	669	699								
Current cons. in A	1.72	1.82	1.95	2.11	2.23	2.29	2.49	2.72	2.81								
COP in W/W	0.61	0.82	1.05	1.28	1.44	1.52	1.76	2.00	2.10								

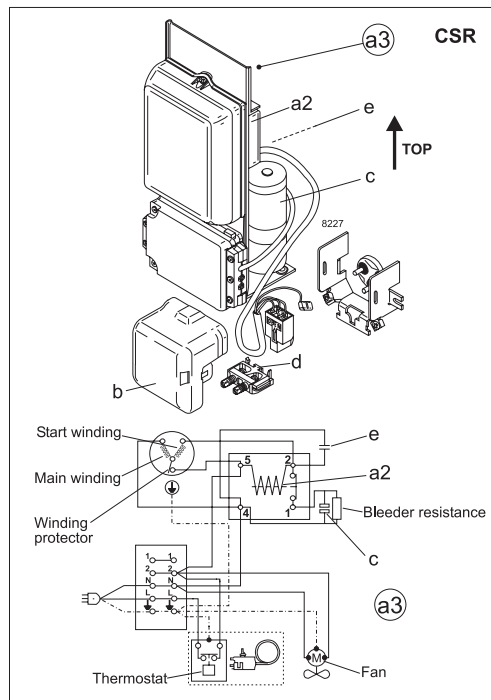

Accessories for	SC12CLX.2 (60 Hz)	Figure	Code number	Test conditions	EN 12900/CECOMAF*	ASHRAE LBP	ASHRAE LBP*
Starting device	550 mm cable length	a3	117-7027	Condensing temperature	45°C	54.4°C	43.3°C
	650 mm cable length		117-7046	Ambient temperature	32°C	32°C	32°C
	1000 mm cable length		117-7040	Suction gas temperature	32°C	32°C	32°C
Cover		b	103N2008	Liquid temperature	no subcooling	32°C	32°C
Starting relay	6.3 mm spade connectors	a2	Components of starting device	Mounting accessories			
Start. capacitor 80 µF	6.3 mm spade connectors	c		Bolt joint for one comp.	Ø: 16 mm	118-1917	
Run capacitor 10 µF	6.3 mm spade connectors	e		Bolt joint in quantities	Ø: 16 mm	118-1918	
Cord relief		d	103N1004	Snap-on in quantities	Ø: 16 mm	118-1919	

Secop accepts no responsibility for possible errors in catalogs, brochures, and other printed material. Secop reserves the right to alter its products without notice. This also applies to products already on order provided that such alterations can be made without subsequential changes being necessary to specifications already agreed. All trademarks in this material are the property of the respective companies. Secop and the Secop logotype are trademarks of Secop GmbH. All rights reserved. www.secop.com

SC12CLX.2 LBP Compressor R404A/R507 208-230V 60Hz

General

Code number	104L2699
Approvals	UL984, KC
Compressors on pallet	80

Application

Application	LBP/MBP			
Frequency	Hz	50	60	
Evaporating temperature	°F	-	-49 to 41	
Voltage range	V	-	187 - 254	
Max. condensing temperature continuous (short)	°F	-	131 (140)	
Max. winding temperature continuous (short)	°F	-	257 (275)	

Cooling requirements

Frequency	Hz	50			60		
Application		LBP	MBP	HBP	LBP	MBP	HBP
90°F		-	-	-	F ₂	-	-
100°F		-	-	-	F ₂	-	-
110°F		-	-	-	F ₂	-	-
Remarks on application:							

Motor

Motor type	CSR		
LRA (rated after 4 sec. UL984), HST LST	A	19.6	-
Cut in Current, HST LST	A	19.6	-
Resistance, main start winding (77°F)	Ω	3.8	13.7

Design

Displacement	cu.in	0.78
Oil quantity (type)	fl.oz.	16.9 (polyolester)
Maximum refrigerant charge	oz.	45.8
Free gas volume in compressor	fl.oz.	51.1
Weight without electrical equipment	lbs.	27.7

Dimensions

Height	inch	A	8.62
		B	8.39
		B1	7.60
		B2	4.33
Suction connector	location, I.D. in. angle	C	0.378-0.385 37°
	material comment		Copper Rubber plug
Process connector	location, I.D. in. angle	D	0.252-0.259 37°
	material comment		Copper Rubber plug
Discharge connector	location, I.D. in. angle	E	0.252-0.259 37°
	material comment		Copper Rubber plug
Oil cooler connector	location, I.D. in. angle	F	-
	material comment		-
Remarks:			

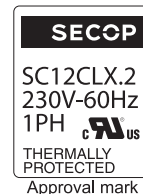
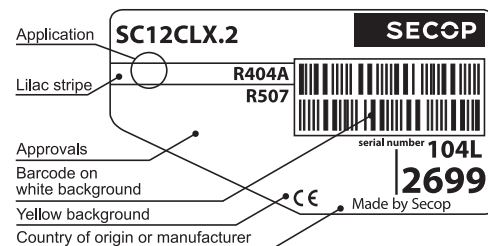

- S = Static cooling normally sufficient
- O = Oil cooling
- F₁ = Fan cooling 1.5 m/s
(compressor compartment temperature equal to ambient temperature)
- F₂ = Fan cooling 3.0 m/s necessary
- SG = Suction gas cooling normally sufficient
- = not applicable in this area

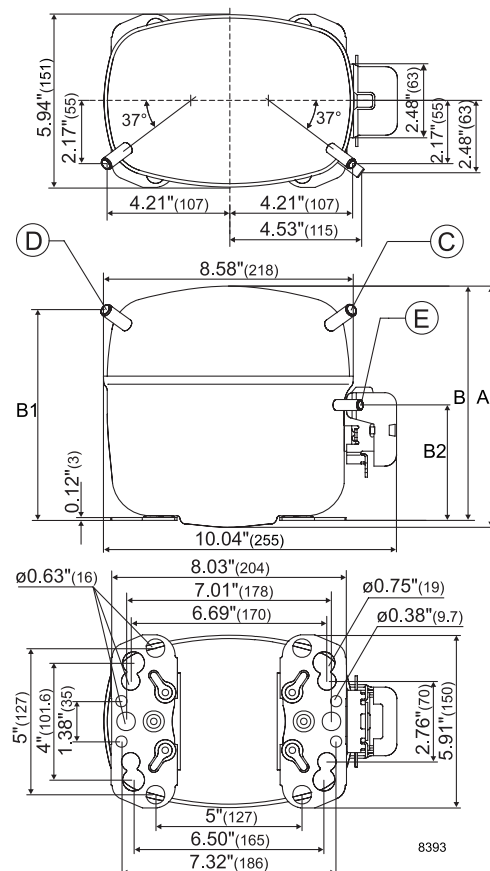

ASHRAE LBP

230V, 60Hz, fan cooling F₂

Evap. temp. in °F	-49	-40	-30	-20	-13	-10	0	10	14	20	30	40	41	45	50	59	68
Capacity in BTU/h	281	649	1133	1712	2183	2404	3229	4205	4642								
Power cons. in W	264	334	409	482	534	556	632	711	744								
Current cons. in A	1.57	1.71	1.88	2.08	2.23	2.30	2.54	2.80	2.91								
EER in BTU/Wh	1.06	1.94	2.77	3.55	4.09	4.32	5.11	5.91	6.24								

ASHRAE LBP*

230V, 60Hz, fan cooling F₂

Evap. temp. in °F	-49	-40	-30	-20	-13	-10	0	10	14	20	30	40	41	45	50	59	68
Capacity in BTU/h	598	962	1449	2036	2516	2740	3575	4556	4994								
Power cons. in W	289	345	406	468	512	531	598	669	699								
Current cons. in A	1.72	1.82	1.95	2.11	2.23	2.29	2.49	2.72	2.81								
EER in BTU/Wh	2.07	2.79	3.57	4.35	4.91	5.16	5.98	6.81	7.15								

EN 12900 Household (CECOMAF)

230V, 60Hz, fan cooling F₂

Evap. temp. in °F	-49	-40	-30	-20	-13	-10	0	10	14	20	30	40	41	45	50	59	68
Capacity in BTU/h	481	796	1216	1721	2133	2326	3042	3883	4257								
Power cons. in W	286	344	407	470	515	535	602	674	705								
Current cons. in A	1.70	1.81	1.95	2.11	2.24	2.29	2.50	2.73	2.83								
EER in BTU/Wh	1.68	2.31	2.99	3.66	4.14	4.35	5.05	5.76	6.04								

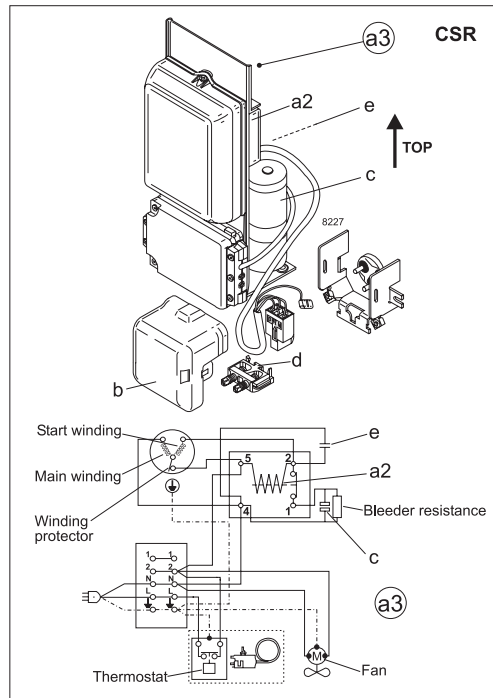

Accessories for	SC12CLX.2 (60Hz)	Figure	Code number
Starting device	21.7 in. cable length	a3	117-7027
	26.6 in. cable length		117-7046
	39.4 in. cable length		117-7040
Cover		b	103N2008
Starting relay		a2	Components of starting device
Start. capacitor 80 µF		c	
Run capacitor 10 µF		e	
Cord relief		d	

Test conditions	ASHRAE LBP	ASHRAE LBP*	EN 12900/CECOMAF*
Condensing temperature	130°F	110°F	113°F
Ambient temperature	90°F	90°F	90°F
Suction gas temperature	90°F	90°F	90°F
Liquid temperature	90°F	90°F	no subcooling

Mounting accessories	Code number	
Bolt joint for one comp.	Ø: 5/8 in.	118-1917
Bolt joint in quantities	Ø: 5/8 in.	118-1918
Snap-on in quantities	Ø: 5/8 in.	118-1919

Secop accepts no responsibility for possible errors in catalogs, brochures, and other printed material. Secop reserves the right to alter its products without notice. This also applies to products already on order provided that such alterations can be made without substantial changes being necessary to specifications already agreed. All trademarks in this material are the property of the respective companies. Secop and the Secop logotype are trademarks of Secop GmbH. All rights reserved. www.secop.com



SC Compressors





SC Compressors

Service/Repair – R290



8545



Secop accepts no responsibility for possible errors in catalogs, brochures, and other printed material. Secop reserves the right to alter its products without notice. This also applies to products already on order provided that such alterations can be made without subsequent changes being necessary to specifications already agreed. All trademarks in this material are the property of the respective companies. Secop and the Secop logotype are trademarks of Secop GmbH. All rights reserved. www.secop.com