

## Single Pack TL2.5G 220-240V 50/60Hz CSIR

Single pack code number: **195B4458**

Position	Title	Code	Amount
1	Compressor TL2.5G	102G4251	1
2	Starting relay	117U6007	1
3	Starting capacitor (60 $\mu$ F 220V, 6.3mm)	117U5014	1
4	Cord relief	103N1010	1
5	Cover	103N2010	1
6	Bolt joint for one compressor   M6   $\varnothing$ 16mm	118-1917	1

Secop GmbH • Lise-Meitner-Straße 29 • 24941 Flensburg, Germany • Tel: +49 461 4941 0 • [www.secop.com](http://www.secop.com)

Secop accepts no responsibility for possible errors in catalogs, brochures, and other printed material. Secop reserves the right to alter its products without notice. This also applies to products already on order provided that such alterations can be made without subsequent changes being necessary to specifications already agreed. All trademarks in this material are the property of the respective companies. Secop and the Secop logotype are trademarks of Secop GmbH. All rights reserved.

## TL2.5G Universal Compressor R134a 220-240V 50/60Hz

### General

Code number	102G4251
Approvals	EN 60335-2-34 Annex AA, UL984
Compressors on pallet	125

### Application

Application	LBP/HBP			
	Hz	50	60	
Frequency	Hz	50	60	
Evaporating temperature	°C	-35 to 15	-35 to 15	
Voltage range	V	187 - 254	198 - 254	
Max. condensing temperature continuous (short)	°C	60 (70)	60 (70)	
Max. winding temperature continuous (short)	°C	125 (135)	125 (135)	

### Cooling requirements

Frequency	Hz	50			60		
		LBP	MBP	HBP	LBP	MBP	HBP
32°C		S	S	S	S	S	S
38°C		S	S	S	S	S	S
43°C		S	S	F <sub>2</sub>	S	S	F <sub>2</sub>
Remarks on application: HBP 50Hz: 198 - 254V HBP 60Hz: 207 - 254V							

### Motor

Motor type	RSIR/CSIR		
LRA (rated after 4 sec. UL984), HST   LST	A	4.5	2.8
Cut in Current, HST   LST	A	4.5	7.2
Resistance, main   start winding (25°C)	Ω	32.7	15.5

### Design

Displacement	cm <sup>3</sup>	2.61
Oil quantity (type)	cm <sup>3</sup>	280 (polyolester)
Maximum refrigerant charge	g	400
Free gas volume in compressor	cm <sup>3</sup>	1600
Weight without electrical equipment	kg	6.7

### Dimensions

Height	mm	A	163
		B	159
		B1	-
		B2	-
Suction connector	location/I.D. mm   angle	C	6.2   30°
	material   comment	Copper   Rubber plug	
Process connector	location/I.D. mm   angle	D	6.2   31.5°
	material   comment	Copper   Rubber plug	
Discharge connector	location/I.D. mm   angle	E	5.0   28°
	material   comment	Copper   Rubber plug	
Oil cooler connector	location/I.D. mm   angle	F	-
	material   comment	-	
Connector tolerance	I.D. mm	±0.09, on 5.0 +0.12/+0.20	
Remarks:			

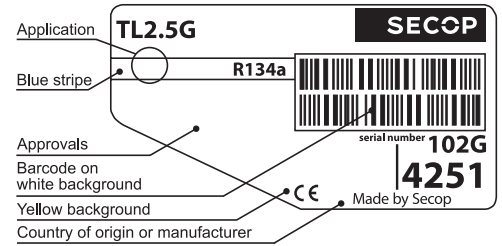

- S = Static cooling normally sufficient
- O = Oil cooling
- F<sub>1</sub> = Fan cooling 1.5 m/s (compressor compartment temperature equal to ambient temperature)
- F<sub>2</sub> = Fan cooling 3.0 m/s necessary
- SG = Suction gas cooling normally sufficient
- = not applicable in this area

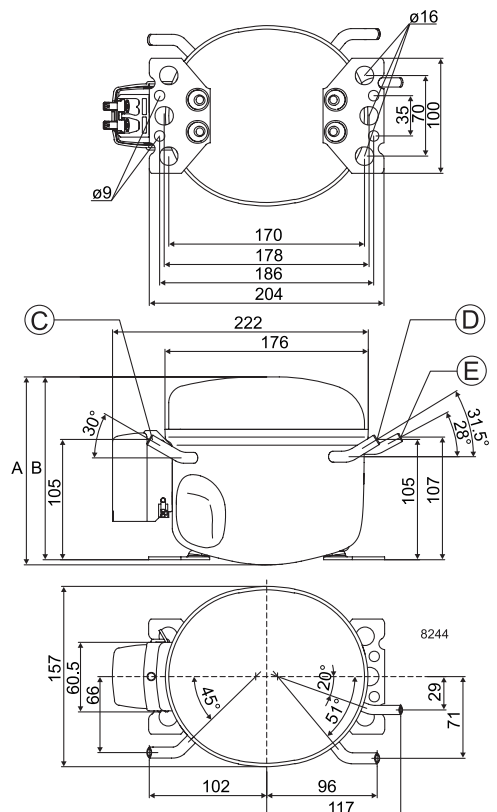

**EN 12900 Household (CECOMAF)** 220V, 50Hz, static cooling

Evap. temp. in °C	-45	-40	-35	-30	-25	-23.3	-20	-15	-10	-6.7	-5	0	5	7.2	10	15	20
Capacity in W			11.0	22.4	35.5	40.5	50.9	69.0	90.4	107	116	145	179	196	219	264	
Power cons. in W			47.6	53.1	59.6	62.0	67.0	75.1	83.9	90.0	93.3	103	113	118	124	134	
Current cons. in A			0.48	0.49	0.50	0.51	0.52	0.53	0.55	0.57	0.58	0.60	0.63	0.64	0.66	0.70	
COP in W/W			0.23	0.42	0.60	0.65	0.76	0.92	1.08	1.18	1.24	1.41	1.58	1.66	1.77	1.97	

**EN 12900 Household (CECOMAF)** 220V, 60Hz, static cooling

Evap. temp. in °C	-45	-40	-35	-30	-25	-23.3	-20	-15	-10	-6.7	-5	0	5	7.2	10	15	20
Capacity in W			13.5	26.7	41.9	47.6	59.6	80.5	105	124	134	168	208	227	253	306	
Power cons. in W			53.2	59.8	67.5	70.4	76.3	85.9	96.3	104	107	119	131	137	144	156	
Current cons. in A			0.46	0.47	0.48	0.49	0.50	0.51	0.53	0.55	0.55	0.58	0.61	0.62	0.64	0.67	
COP in W/W			0.25	0.45	0.62	0.68	0.78	0.94	1.09	1.19	1.25	1.41	1.58	1.66	1.77	1.96	

**ASHRAE LBP** 220V, 50Hz, static cooling

Evap. temp. in °C	-45	-40	-35	-30	-25	-23.3	-20	-15	-10	-6.7	-5	0	5	7.2	10	15	20
Capacity in W			14.3	28.4	44.6	50.7	63.6	86.1	113	133	144	181	224	245	274	331	
Power cons. in W			47.5	53.0	59.5	61.9	66.9	75.0	83.7	89.8	93.0	103	113	117	123	134	
Current cons. in A			0.48	0.49	0.50	0.50	0.51	0.53	0.55	0.57	0.58	0.60	0.63	0.64	0.66	0.69	
COP in W/W			0.30	0.53	0.75	0.82	0.95	1.15	1.35	1.48	1.55	1.76	1.98	2.09	2.22	2.48	

**ASHRAE LBP** 220V, 60Hz, static cooling

Evap. temp. in °C	-45	-40	-35	-30	-25	-23.3	-20	-15	-10	-6.7	-5	0	5	7.2	10	15	20
Capacity in W			17.5	33.8	52.5	59.5	74.4	100	131	154	167	210	259	284	317	383	
Power cons. in W			53.1	59.7	67.4	70.2	76.1	85.7	96.1	103	107	119	131	136	143	155	
Current cons. in A			0.46	0.47	0.48	0.49	0.50	0.51	0.53	0.55	0.55	0.58	0.61	0.62	0.64	0.67	
COP in W/W			0.33	0.57	0.78	0.85	0.98	1.17	1.36	1.49	1.56	1.77	1.99	2.09	2.22	2.47	



Accessories for	TL2.5G	Figure	Code number
PTC starting device	6.3 mm spade connectors	a1	103N0011
	4.8 mm spade connectors		103N0018
Starting relay	6.3 mm spade connectors	a2	117U6007
Start. capacitor 60 µF	6.3 mm spade connectors	c	117U5014
Cover		b	103N2011
Cord relief		d	103N1010
Protection screen for PTC		g	103N0476

Test conditions	EN 12900/CECOMAF	ASHRAE LBP
Condensing temperature	55°C	54.4°C
Ambient temperature	32°C	32°C
Suction gas temperature	32°C	32°C
Liquid temperature	55°C	32°C

Mounting accessories		Code number
Bolt joint for one comp.	Ø: 16 mm	118-1917
Bolt joint in quantities	Ø: 16 mm	118-1918
Snap-on in quantities	Ø: 16 mm	118-1919

Secop accepts no responsibility for possible errors in catalogs, brochures, and other printed material. Secop reserves the right to alter its products without notice. This also applies to products already on order provided that such alterations can be made without substantial changes being necessary to specifications already agreed. All trademarks in this material are the property of the respective companies. Secop and the Secop logotype are trademarks of Secop GmbH. All rights reserved. [www.secop.com](http://www.secop.com)



# TL Compressors





## Service/Repair – R600a, R290



8545

## Brazing on Suction Connectors (Direct Intake)

representative image



**! max. 150°C/302°F !  
at socket**  
brazing solder: phosphor (LP7) or silver

Refer to Product Bulletin:  
**Brazing on Suction Connectors  
(Compressors with Direct Suction Intake)**

Secop accepts no responsibility for possible errors in catalogs, brochures, and other printed material. Secop reserves the right to alter its products without notice. This also applies to products already on order provided that such alterations can be made without subsequential changes being necessary to specifications already agreed. All trademarks in this material are the property of the respective companies. Secop and the Secop logotype are trademarks of Secop GmbH. All rights reserved. [www.secop.com](http://www.secop.com)