

Single Pack NLE12.6CNS 115-127V 60Hz CSIR

Single pack code number: **195B4610**

Position	Title	Code	Amount
1	Compressor NLE12.6CNS	105H6392	1
2	Cord relief	103N1010	1
3	Cover	103N2011	1
4	Starting capacitor (180 μ F 125V, 6.3mm)	117U5039	1
5	Starting relay	117U7023	1
6	Bolt joint for one compressor M6 \varnothing 16mm	118-1917	1

Secop GmbH • Lise-Meitner-Straße 29 • 24941 Flensburg, Germany • Tel: +49 461 4941 0 • www.secop.com

Secop accepts no responsibility for possible errors in catalogs, brochures, and other printed material. Secop reserves the right to alter its products without notice. This also applies to products already on order provided that such alterations can be made without subsequent changes being necessary to specifications already agreed. All trademarks in this material are the property of the respective companies. Secop and the Secop logotype are trademarks of Secop GmbH. All rights reserved.

Model

Designation	NLE12.6CNS	115-127V/60Hz 1~	Sales code:	105H6392
-------------	-------------------	------------------	-------------	-----------------

Compressor design

Oil type	Polyolester	Refrigerant(s)	R290
Oil viscosity	32cST	Displacement	12,55cm ³ / 0,77cu.in
Oil quantity	298cm ³ / 10,1fl.oz	Compressors on pallet	80
Refr. charge - tech. limit	300g / 10,6oz		
Free gas volume comp.	2360cm ³ / 79,8fl.oz		
Weight	11,7kg / 25,8lbs		
Motor protection	1# internal		
Winding resistance main	1Ω (at 25°C)		
Winding resistance aux	3,3Ω (at 25°C)		
Max. winding temp.	125°C / 257°F		
Max. discharge temp.	130°C / 266°F		



General - Configurations with NLE12.6CNS

	Conf. 1	Conf. 2
Motorconfiguration	CSIR	RSCR
Power supply (nominal)	115V/60Hz	115V/60Hz
Number of phases	1	1
Voltage range	103-135V	103-135V
Approvals	UL	UL
Starting torque	HST	LST
Note	Important: compressor is optimized for strong power supply and oversized heat exchangers.	

Applications with NLE12.6CNS

	Conf. 1	Conf. 2
Refrigerant	R290	R290
Application	LBP+MBP	LBP+MBP
System cooling	fan 3m/s	fan 3m/s
Hot gas defrost	OK	OK
Long interval pull down	OK	OK

Electrical data - Configurations with NLE12.6CNS

	Conf. 1	Conf. 2
Starting device type	relay	PTC
Run capacitor	-/-	23,5μF
Start capacitor	180μF	-/-
LRA (locked rotor amps / 4s)	31A	
RLA (rated load amps / 1s)	6,4A	6,4A
Cut in current	31A	43,8A

Model

Designation

NLE12.6CNS

115-127V/60Hz 1~

Sales code:

105H6392

Compressor dimensions

Housing	A Height	203mm / 7,99in
	B Height	197mm / 7,76in
	C Length shell	205mm / 8,07in
	D Length w. cover	254mm / 10in
	E Width	166mm / 6,54in

Connectors		Suction	Discharge	Process
		X	Y	Z
Diameter	[mm]	øi 8,11-8,29	øi 6,41-6,59	øi 6,41-6,59
	(i:inside, o:outside) [in]	øi 0,32-0,33	øi 0,25-0,26	øi 0,25-0,26
Material		copper	copper	copper
Horizontal angle	±2°	0°	0°	0°
Vertical angle	±2°	15°	21°	155°
Position l/h/w	[mm]	132/69/57	94/102/81	-109/94/72
	[in]	5,2/2,7/2,2	3,7/4/3,2	-4,3/3,7/2,8
Straight tube l.	[mm]	12	12	12
	[in]	0,5	0,5	0,5



Compressor fixation



Bolt joint

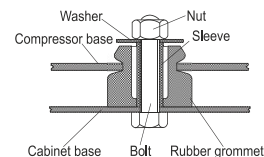

Snap-on

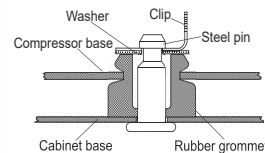

Mounting accessories

	one comp.	multi pack
Bolt joint M6 ø16mm	118-1917	118-1918
Bolt joint ø1/4" ø16mm	118-1946	
Bolt joint ø1/4" ø19mm	118-1949	
Snap-on ø7,3 ø16mm	118-1947	118-1919

Application notes

Important: compressor is optimized for strong power supply and oversized heat exchangers.

Tailor made for supermarket applications.

Provision for PE Grounding is located at the PE Stamp on the compressor

Model

Designation	NLE12.6CNS	115V/60Hz	Conf. 1	Sales code:	105H6392
-------------	-------------------	------------------	----------------	-------------	-----------------

Configuration

Motorconfiguration	CSIR
Power supply (nominal)	115V/60Hz 1~
Refrigerant	R290
Application	LBP+MBP
Voltage range	103-135V
Starting torque	HST
Approvals	UL

Electrical accessories / wiring diagram



Ambient/ machine room temperatures minimum /maximum

Ambient temperature range: 10 - 38°C / 50 - 101°F

Machine room temperature range: 10 - 43°C / 50 - 110°F

Compressor cooling: fan 3m/s

Operation pressure range

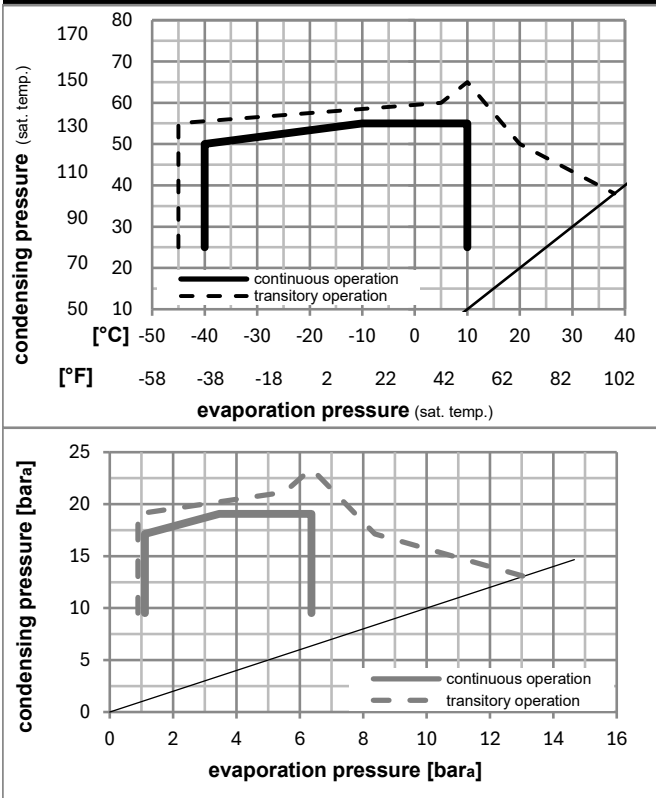

Components

a2	current relay	117U7023
c	start capacitor (180µF)	117U5039
b	plastic cover	103N2011
d	cord relief	103N1010

Model

Designation	NLE12.6CNS	115V/60Hz	Conf. 1	Sales code:	105H6392
-------------	-------------------	------------------	----------------	-------------	-----------------

Optimization + standard conditions

R290, 115V/60Hz, CSIR, fan 3m/s, UL

	Evaporating pressure (saturation temperature)				Cooling capacity			COP	EER	P1	Power consumption		ASHRAE LBP	
	pe	pc	RGT	Tliq	[W]	[Btu/h]	[kcal/h]				I	m		
	[°C]	[°F]	[°C]	[°F]	[W]	[Btu/h]	[kcal/h]	[W/W]	[Btu/Wh]	[kcal/Wh]	[W]	[A]	[kg/h]	
	-23	54	32	32	748,4	2556	644,1	1,60	5,47	1,38	467,3	5,35	7,58	ASHRAE LBP
	-10	130	90	90										
	-25	55	32	55	555,6	1897	478,1	1,25	4,26	1,07	445,6	5,17	6,92	cecomaf LBP
	-13	131	90	131										
	-35	40	20	40	418,5	1429	360,1	1,32	4,51	1,14	317,0	4,10	4,78	EN12900 LBP
	-31	104	68	104										
	-7	54	35	46	1340,0	4576	1153,2	1,98	6,76	1,70	676,5	7,09	15,29	ASHRAE MBP
	20	130	95	115										
	-10	55	32	55	1070,9	3657	921,6	1,68	5,72	1,44	639,1	6,78	13,55	cecomaf MBP
	14	131	90	131										
	-10	45	20	45	1180,6	4032	1016,0	2,00	6,83	1,72	590,7	6,37	14,50	EN12900 MBP
	14	113	68	113										

Performance tables

R290, 115V/60Hz, CSIR, fan 3m/s, UL

	pe		Cooling capacity			COP	EER		P1	I	m
	[°C]	[°F]	[W]	[Btu/h]	[kcal/h]		[Btu/Wh]	[kcal/Wh]			
[°C / °F]	-40	-40	278,1	950	239,3	1,09	3,71	0,94	255,8	3,59	3,11
cond. pressure	-34	-30	403,3	1377	347,1	1,25	4,27	1,08	322,5	4,15	4,52
pc= 45/113	-23	-10	718,1	2453	618,0	1,59	5,44	1,37	450,6	5,21	8,11
return gas temp.	-15	5	1018,8	3479	876,8	1,89	6,44	1,62	540,3	5,96	11,59
RGT= 32/90	-4	25	1519,0	5188	1307,2	2,34	8,00	2,02	648,4	6,85	17,52
liquid temp	0	32	1723,5	5886	1483,3	2,52	8,62	2,17	682,6	7,14	19,99
Tliq= 45/113	10	50	2326,6	7946	2002,3	3,06	10,45	2,63	760,3	7,78	27,49
[°C / °F]	-40	-40	183,2	626	157,7	0,77	2,63	0,66	237,9	3,45	2,26
cond. pressure	-34	-30	307,0	1049	264,2	0,97	3,32	0,84	315,9	4,09	3,80
pc= 55/131	-23	-10	605,0	2066	520,7	1,29	4,42	1,11	467,9	5,35	7,54
return gas temp	-15	5	880,7	3008	758,0	1,53	5,22	1,31	576,7	6,26	11,07
RGT= 32/90	-4	25	1331,1	4546	1145,5	1,87	6,39	1,61	711,9	7,38	16,99
liquid temp	0	32	1513,7	5170	1302,7	2,00	6,84	1,72	756,0	7,75	19,44
Tliq= 55/131	10	50	2050,0	7001	1764,3	2,38	8,14	2,05	860,0	8,61	26,88

Model

Designation	NLE12.6CNS	115V/60Hz	Conf. 2	Sales code:	105H6392
-------------	-------------------	------------------	----------------	-------------	-----------------

Configuration

Motorconfiguration	RSCR
Power supply (nominal)	115V/60Hz 1~
Refrigerant	R290
Application	LBP+MBP
Voltage range	103-135V
Starting torque	LST
Approvals	UL

Electrical accessories / wiring diagram

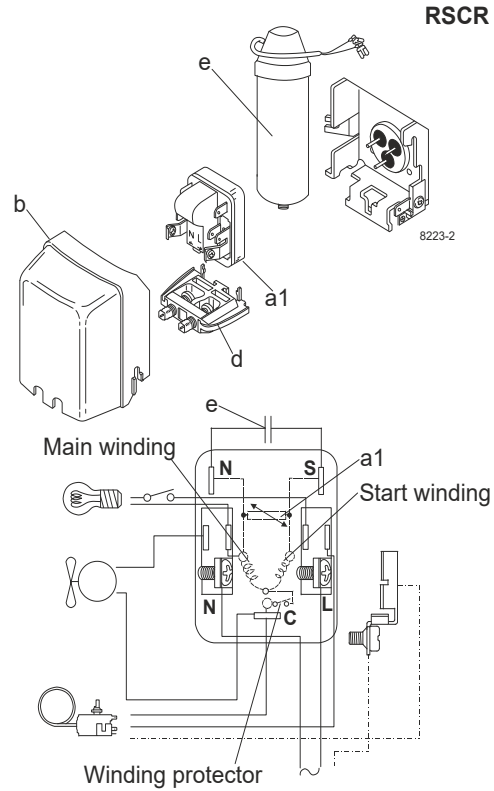

Ambient/ machine room temperatures minimum /maximum

Ambient temperature range:	10 - 38°C / 50 - 101°F
Machine room temperature range:	10 - 43°C / 50 - 110°F
Compressor cooling:	fan 3m/s

Operation pressure range

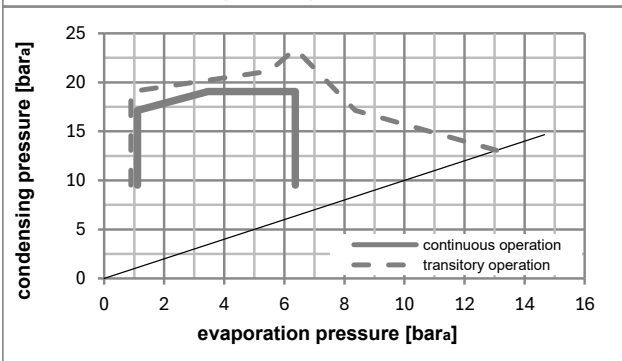
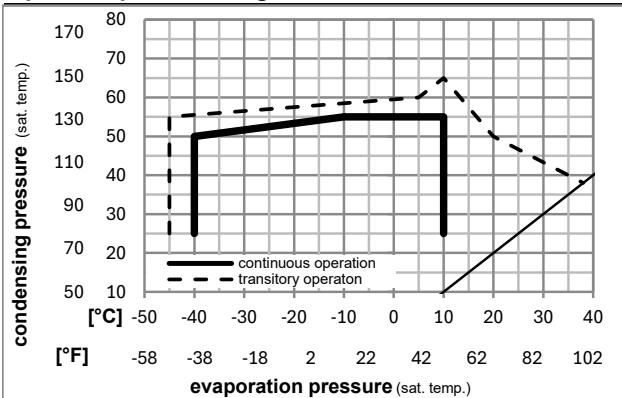

Components

a1	e-PTC starter	103N0058
e	run capacitor (23,5μF, 6.3mm)	117-7114
b	plastic cover	103N2011
d	cord relief	103N1010
	bracket for run capacitor	117-0300
	screw M4x8mm	117-0301

Model

Designation	NLE12.6CNS	115V/60Hz	Conf. 2	Sales code:	105H6392
-------------	-------------------	------------------	----------------	-------------	-----------------

Optimization + standard conditions

R290, 115V/60Hz, RSCR, fan 3m/s, UL

		Evaporating pressure (saturation temperature)				Cooling capacity			COP	EER	Power consumption				
		Condensing pressure (saturation temperature)		Return gas temp.	Liquid temp.	[W]	[Btu/h]	[kcal/h]	[W/W]	[Btu/Wh]	[kcal/Wh]	P1	I	Ref. mass flow	
[°C]	[°F]	pe	pc	RGT	Tliq							[W]	[A]	[kg/h]	
-23	-10	54	130	32	90	750,4	2563	645,8	1,70	5,81	1,46	440,9	3,97	7,60	ASHRAE LBP
-25	-13	55	131	32	90	557,0	1902	479,3	1,32	4,52	1,14	421,1	3,81	6,94	cecomaf LBP
-35	-31	40	104	20	68	419,0	1431	360,6	1,38	4,72	1,19	302,9	3,11	4,79	EN12900 LBP
-7	20	54	130	35	95	1346,5	4598	1158,8	2,14	7,31	1,84	629,3	5,59	15,36	ASHRAE MBP
-10	14	55	131	32	90	1075,5	3673	925,6	1,80	6,16	1,55	596,0	5,30	13,60	cecomaf MBP
-10	14	45	113	20	68	1185,0	4047	1019,8	2,14	7,32	1,85	552,7	4,96	14,55	EN12900 MBP

Performance tables

R290, 115V/60Hz, RSCR, fan 3m/s, UL

	pe		Cooling capacity			COP	EER	P1			I	m
	[°C]	[°F]	[W]	[Btu/h]	[kcal/h]	[W/W]	[Btu/Wh]	[kcal/Wh]	[W]	[A]	[kg/h]	
[°C / °F]	-40	-40	278,1	950	239,3	1,13	3,87	0,97	245,5	2,64	3,11	
cond. pressure	-34	-30	403,9	1379	347,6	1,31	4,48	1,13	307,9	3,06	4,53	
pc= 45/113	-23	-10	720,0	2459	619,6	1,69	5,77	1,45	425,9	3,93	8,13	
return gas temp.	-15	5	1022,1	3491	879,7	2,01	6,88	1,73	507,3	4,58	11,63	
RGT= 32/90	-4	25	1525,8	5211	1313,1	2,52	8,62	2,17	604,4	5,41	17,59	
liquid temp	0	32	1732,1	5915	1490,7	2,73	9,32	2,35	634,9	5,68	20,09	
Tliq= 45/113	10	50	2341,8	7998	2015,4	3,32	11,36	2,86	704,3	6,31	27,67	
[°C / °F]	-40	-40	183,4	626	157,8	0,80	2,74	0,69	228,5	2,38	2,26	
cond. pressure	-34	-30	307,6	1050	264,7	1,02	3,48	0,88	301,5	2,90	3,80	
pc= 55/131	-23	-10	606,6	2072	522,1	1,37	4,69	1,18	441,5	3,98	7,56	
return gas temp	-15	5	883,9	3019	760,7	1,64	5,59	1,41	540,0	4,80	11,11	
RGT= 32/90	-4	25	1338,2	4570	1151,7	2,03	6,92	1,74	660,8	5,89	17,08	
liquid temp	0	32	1523,0	5201	1310,7	2,18	7,43	1,87	699,9	6,25	19,56	
Tliq= 55/131	10	50	2066,7	7058	1778,7	2,61	8,91	2,25	791,7	7,14	27,10	



NL Compressors





Service/Repair – R600a, R290

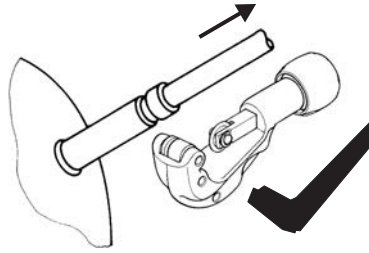
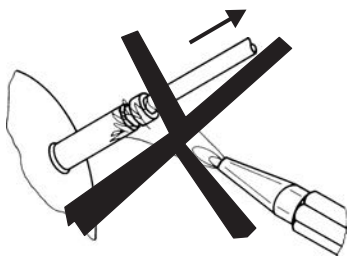

8545

Brazing on Suction Connectors (Direct Intake)

representative image



**! max. 150°C/302°F !
at socket**
brazing solder: phosphor (LP7) or silver

Refer to Product Bulletin:
**Brazing on Suction Connectors
(Compressors with Direct Suction Intake)**

Secop accepts no responsibility for possible errors in catalogs, brochures, and other printed material. Secop reserves the right to alter its products without notice. This also applies to products already on order provided that such alterations can be made without subsequential changes being necessary to specifications already agreed. All trademarks in this material are the property of the respective companies. Secop and the Secop logotype are trademarks of Secop GmbH. All rights reserved. www.secop.com