

Single Pack KLF5.6CNH 115-127V 60Hz CSIR

Single pack code number: **195B4699**

Position	Title	Code	Amount
1	Compressor KLF5.6CNH	106H3611	1
2	Bolt joint for one compressor M6 ø16mm	118-1917	1

Secop GmbH • Lise-Meitner-Straße 29 • 24941 Flensburg, Germany • Tel: +49 461 4941 0 • www.secop.com

Secop accepts no responsibility for possible errors in catalogs, brochures, and other printed material. Secop reserves the right to alter its products without notice. This also applies to products already on order provided that such alterations can be made without subsequent changes being necessary to specifications already agreed. All trademarks in this material are the property of the respective companies. Secop and the Secop logotype are trademarks of Secop GmbH. All rights reserved.

Model

Designation	KLF5.6CNH	115-127V/60Hz 1~	Sales code:	106H3611
-------------	------------------	------------------	-------------	-----------------

Compressor design

Oil type	Polyolester	Refrigerant(s)	R290
Oil viscosity	10,4cSt	Displacement	5,6cm ³ / 0,34cu.in
Oil quantity	174cm ³ / 5,9fl.oz	Compressors on pallet	100
Refr. charge - tech. limit	200g / 7,1oz		
Free gas volume comp.	1605cm ³ / 54,3fl.oz		
Weight	9,5kg / 20,9lbs		
Motor protection	external		
Winding resistance main	2Ω (at 25°C)		
Winding resistance aux	5,3Ω (at 25°C)		
Max. winding temp.	125°C / 257°F		
Max. discharge temp.	130°C / 266°F		



General - Configurations with KLF5.6CNH

	Conf. 1
Motorconfiguration	CSIR
Power supply (nominal)	115-127V/60Hz
Number of phases	1
Voltage range	95-140V
Approvals	UL, CCC
Starting torque	HST
Note	Electrical equipment is included and pre-assembled to compressor.

Applications with KLF5.6CNH

	Conf. 1
Refrigerant	R290
Application	LBP+MBP
System cooling	fan 3m/s
Hot gas defrost	OK
Long interval pull down	OK

Electrical data - Configurations with KLF5.6CNH

	Conf. 1
Starting device type	relay
Run capacitor	-/-
Start capacitor	240μF
LRA (locked rotor amps / 4s/ U(N))	31,1A
RLA (rated load amps / 1s/ U(N))	4,3A
Cut in current (U(N))	27,8A

Model

Designation

KLF5.6CNH

115-127V/60Hz 1~

Sales code:

106H3611

Compressor dimensions

Housing	A Height	182mm / 7,17in
	B Height	175mm / 6,89in
	C Length shell	198mm / 7,8in
	D Length w. cover	238mm / 9,37in
	E Width	160mm / 6,3in

Connectors		Suction	Discharge	Process
		X	Y	Z
Diameter	[mm]	øi 8,11-8,29	øi 6,41-6,59	øi 6,41-6,59
(i:inside, o:outside)	[in]	øi 0,32-0,33	øi 0,25-0,26	øi 0,25-0,26
Material		copper	copper	copper
Horizontal angle	±2°	35°	13°	0°
Vertical angle	±2°	30°	40°	145°
Position l/h/w	[mm]	119/73/59	117/107/66	-88/101/71
	[in]	4,7/2,9/2,3	4,6/4,2/2,6	-3,5/4/2,8
Straight tube l.	[mm]	14	14	14
	[in]	0,5	0,5	0,5



Compressor fixation

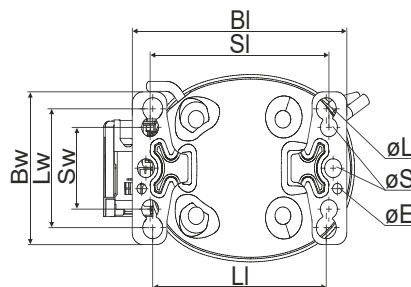

Baseplate	[mm]	[inch]
BI	204	8.03
Bw	132	5.2
øE	ø 9.7	ø 0.38
Large holes	[mm]	[inch]
LJ	165	6.5
Lw	101.6	4
øL	ø 19	ø 0.75
Small holes	[mm]	[inch]
SI	170	6.7
Sw	70	2.76
øS	ø 16	ø 0.63

Bolt joint



Snap-on

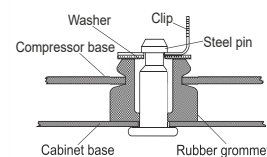

Mounting accessories	one comp.	multi pack
Bolt joint M6 ø16mm	118-1917	118-1918
Bolt joint ø1/4" ø16mm	118-1946	
Bolt joint ø1/4" ø19mm	118-1949	
Snap-on ø7,3 ø16mm	118-1947	118-1919

Application notes

Operation possible until tilted up to 3 degrees

Provision for PE Grounding is located at the PE Stamp on the compressor

Model

Designation	KLF5.6CNH	115-127V/60Hz	Conf. 1	Sales code:	106H3611
-------------	------------------	----------------------	----------------	-------------	-----------------

Configuration

Motorconfiguration	CSIR
Power supply (nominal)	115-127V/60Hz 1~
Refrigerant	R290
Application	LBP+MBP
Voltage range	95-140V
Starting torque	HST
Approvals	UL CCC

Electrical accessories / wiring diagram

CSIR



Ambient/ machine room temperatures minimum /maximum

Ambient temperature range:	10 - 43°C / 50 - 110°F
Machine room temperature range:	10 - 48°C / 50 - 119°F
Compressor cooling:	fan 3m/s

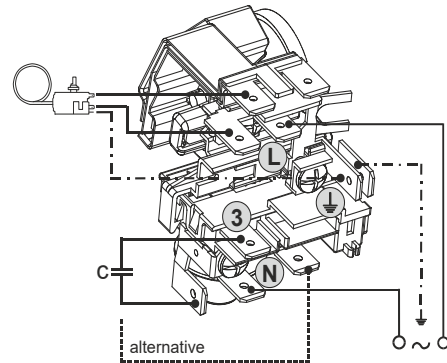

Operation pressure range

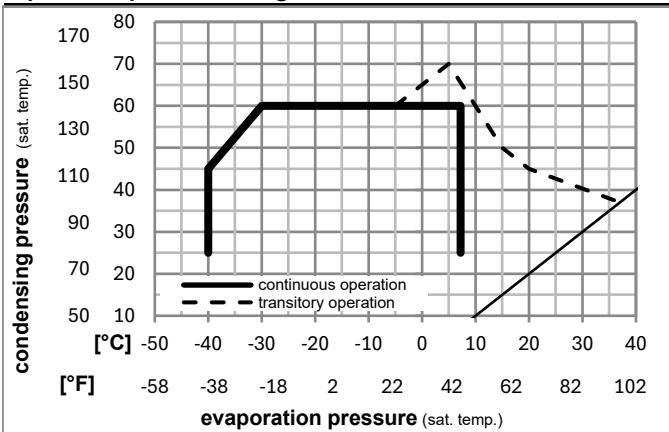

Components (already pre-assembled)

a5	current relay (T1217/L6-S5)	117U7075
c	start capacitor (240µF)	117U5002
.	cable clamp	16058100
b	cover terminal board	10636401
.	screw uni en iso 4757	10641201
.	screw - uni6954	10636000

Alternative comp. (already pre-assembled)

.	screw - uni6954	10636200
---	-----------------	----------

Model

Designation **KLF5.6CNH** **115-127V/60Hz** Conf. 1 Sales code: **106H3611**

Optimization + standard conditions

R290, 115V/60Hz, CSIR, fan 3m/s, UL, CCC

	Evaporating pressure (saturation temperature)				Cooling capacity			COP	EER	Power consumption				
	Condensing pressure (saturation temperature)		Return gas temp.		Liquid temp.	[W]	[Btu/h]	[kcal/h]	[W/W]	[Btu/Wh]	[kcal/Wh]	P1	I	Ref. mass flow
	pe	pc	RGT	Tliq								[W]	[A]	[kg/h]
[°C]														
[°F]														
[°C]	-23	54	32	32	338,8	1157	291,6	1,61	5,49	1,38	210,8	2,78	3,43	ASHRAE LBP
[°F]	-10	130	90	90										
[°C]	-25	55	32	55	253,9	867	218,5	1,26	4,29	1,08	202,3	2,73	3,16	cecomaf LBP
[°F]	-13	131	90	131										
[°C]	-35	40	20	40	189,6	648	163,2	1,25	4,26	1,07	152,2	2,47	2,17	EN12900 LBP
[°F]	-31	104	68	104										
[°C]	-7	54	35	46	609,1	2080	524,2	2,11	7,20	1,81	289,1	3,28	6,95	ASHRAE MBP
[°F]	20	130	95	115										
[°C]	-10	55	32	55	483,5	1651	416,1	1,75	5,98	1,51	276,0	3,19	6,12	cecomaf MBP
[°F]	14	131	90	131										
[°C]	-10	45	20	45	537,8	1837	462,9	2,14	7,30	1,84	251,6	3,03	6,60	EN12900 MBP
[°F]	14	113	68	113										

Performance tables

R290, 115V/60Hz, CSIR, fan 3m/s, UL, CCC

	pe		Cooling capacity			COP	EER	P1			I	m
	[°C]	[°F]	[W]	[Btu/h]	[kcal/h]	[W/W]	[Btu/Wh]	[kcal/Wh]	[W]	[A]	[kg/h]	
[°C / °F]	-40	-40	140,6	480	121,0	1,03	3,53	0,89	135,9	2,41	1,57	
cond. pressure	-34	-30	187,4	640	161,3	1,19	4,07	1,03	157,1	2,49	2,10	
pc= 45/113	-23	-10	321,5	1098	276,7	1,59	5,44	1,37	202,0	2,72	3,63	
return gas temp.	-15	5	460,1	1571	396,0	1,96	6,71	1,69	234,3	2,91	5,23	
RGT= 32/90	-4	25	699,7	2390	602,2	2,60	8,87	2,23	269,5	3,15	8,07	
liquid temp	0	32	799,2	2729	687,8	2,87	9,80	2,47	278,5	3,21	9,27	
Tliq= 45/113	7,2	45	1006,7	3438	866,4	3,48	11,89	3,00	289,1	3,29	11,83	
[°C / °F]	-40	-40	123,2	421	106,0	0,97	3,31	0,83	127,3	2,37	1,52	
cond. pressure	-34	-30	160,9	549	138,5	1,04	3,57	0,90	154,1	2,48	1,99	
pc= 55/131	-23	-10	274,3	937	236,1	1,30	4,44	1,12	210,9	2,78	3,42	
return gas temp	-15	5	395,2	1350	340,1	1,56	5,34	1,35	252,7	3,04	4,97	
RGT= 32/90	-4	25	608,4	2078	523,6	2,02	6,89	1,74	301,4	3,37	7,76	
liquid temp	0	32	697,8	2383	600,6	2,21	7,56	1,90	315,4	3,48	8,96	
Tliq= 55/131	7,2	45	885,6	3024	762,1	2,64	9,02	2,27	335,3	3,63	11,54	



KL Compressors



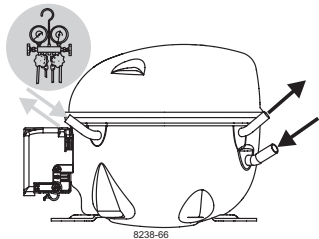

KL Compressors



Service/Repair – R290

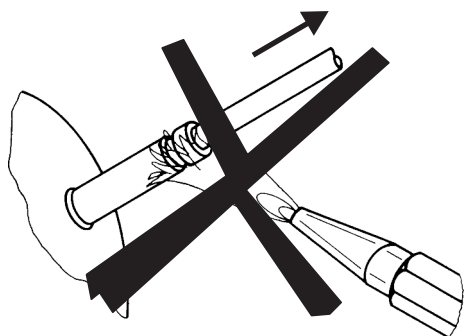

8545

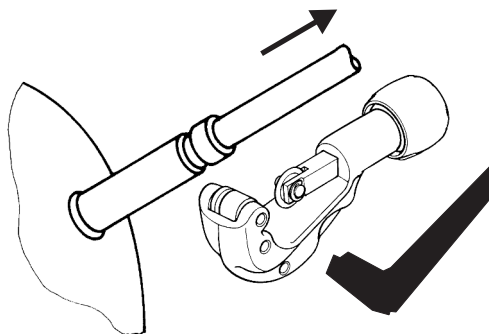

Secop accepts no responsibility for possible errors in catalogs, brochures, and other printed material. Secop reserves the right to alter its products without notice. This also applies to products already on order provided that such alterations can be made without subsequent changes being necessary to specifications already agreed. All trademarks in this material are the property of the respective companies. Secop and the Secop logotype are trademarks of Secop GmbH. All rights reserved. www.secop.com