

Single Pack BD35F 12/24V DC PM

Single pack code number: **195B4757**

Position	Title	Code	Amount
1	Compressor BD35F	101Z0200	1
2	Electronic unit 12/24V DC - Standard	101N0243	1
3	Bolt joint for one compressor M6 ø16mm	118-1917	1

Secop GmbH • Lise-Meitner-Straße 29 • 24941 Flensburg, Germany • Tel: +49 461 4941 0 • www.secop.com

Secop accepts no responsibility for possible errors in catalogs, brochures, and other printed material. Secop reserves the right to alter its products without notice. This also applies to products already on order provided that such alterations can be made without subsequent changes being necessary to specifications already agreed. All trademarks in this material are the property of the respective companies. Secop and the Secop logotype are trademarks of Secop GmbH. All rights reserved.

BD35F Direct Current Compressor R134a, R1234yf 12/24V DC, 10-45V DC Solar & 100-240V AC 50/60Hz



General

Code number (without electronic units)	101Z0200
Electronic unit 12/24V DC - Standard	101N0242, 30 pcs: 101N0243
Electronic unit 12/24V DC - AEO	101N0340, 30 pcs: 101N0341
Electronic unit 10-45V DC - Solar	101N0420, 30 pcs: 101N0421
Electronic unit 12/24V DC & 100-240V AC 50/60Hz	101N0510, 28 pcs: 101N0511
Electronic unit 12/24V DC - Automotive	101N0680, 30 pcs: 101N0681
Compressors on pallet	150

Approvals

R134a	R134a/R1234yf
-	-
VDE	UL
VDE	-
VDE	UL
-	UL / CB



Application

Application	LBP/MBP/HBP
Evaporating temperature °C	-30 to 0 (10)
Voltage range DC VDC	9.6 - 17 / 21.3 - 31.5
Voltage range AC V/Hz	100 - 240 / 50/60
Voltage range for solar applications VDC	10 - 45
Max. condensing temperature continuous (short) °C	60 (70)
Max. winding temperature continuous (short) °C	125 (135)

Cooling requirements

Application	LBP	MBP	HBP
32°C	S	S	S
38°C	S	S	S
43°C	S	S	S

Remarks on application: Fan cooling F₁ depending on application and speed.

Motor

Motor type	variable speed
Resistance, all 3 windings (25°C) Ω	2.2

Design

Displacement cm ³	2.00
Oil quantity (type) cm ³	150 (polyolester)
Maximum refrigerant charge g	300
Free gas volume in compressor cm ³	870
Weight - Compressor/Electronic unit kg	4.3 / 0.19 (Standard)

Standard battery protection settings (refer to electronic unit Instructions for optional settings)

Voltage	12V	24V
Cut out VDC	10.4	22.8
Cut in VDC	11.7	24.2

Dimensions

Height mm	A	137
	B	135
	B1	128
	B2	73
Suction connector location/I.D. mm angle	C	6.2 40°
	material comment	Cu-plated steel Al cap
Process connector location/I.D. mm angle	D	6.2 45°
	material comment	Cu-plated steel Al cap
Discharge connector location/I.D. mm angle	E	5.0 21°
	material comment	Cu-plated steel Al cap
Connector tolerance I.D. mm		±0.09, on 5.0 +0.12/+0.20

Remarks:

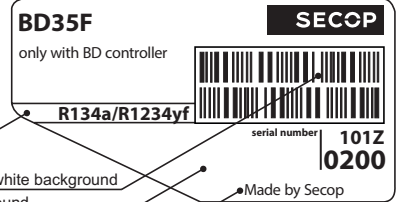

Blue stripe
Barcode on white background
Grey background
Country of origin or manufacturer
Made by Secop

- S = Static cooling normally sufficient
- O = Oil cooling
- F₁ = Fan cooling 1.5 m/s
(compressor compartment temperature equal to ambient temperature)
- F₂ = Fan cooling 3.0 m/s necessary
- SG = Suction gas cooling normally sufficient
- = not applicable in this area

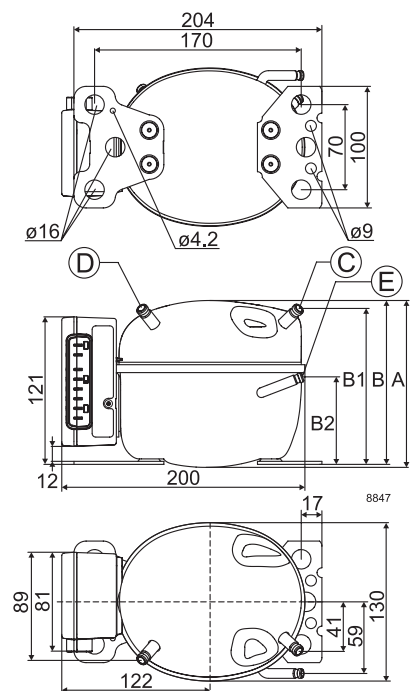

Performance Data with Refrigerant R134a

Capacity (EN 12900 Household/CECOMAF) 12V DC, static cooling watt												
rpm \ °C	-30	-25	-23.3	-20	-15	-10	-5	0	5	7.2	10	15
2,000	16.0	23.8	26.7	32.9	43.7	56.5	71.8	89.8	111	121	136	
2,500	18.8	29.9	33.9	41.9	55.4	71.1	89.8	112	139	152		
3,000	22.4	32.9	37.1	46.1	62.5	82.2	106	133				
3,500	27.0	35.9	40.2	50.3	69.8	93.9	122					

Capacity (ASHRAE LBP) 12V DC, static cooling watt												
rpm \ °C	-30	-25	-23.3	-20	-15	-10	-5	0	5	7.2	10	15
2,000	20.0	29.8	33.4	41.2	54.6	70.6	89.7	112	139	152	169	
2,500	23.6	37.5	42.4	52.4	69.2	88.8	112	140	173	190		
3,000	28.1	41.3	46.5	57.9	78.2	103	132	166				
3,500	33.9	45.1	50.5	63.1	87.3	117	153					

Power consumption 12V DC, static cooling watt												
rpm \ °C	-30	-25	-23.3	-20	-15	-10	-5	0	5	7.2	10	15
2,000	17.7	22.9	24.6	27.7	32.2	36.7	41.3	46.2	51.6	54.3	57.8	
2,500	22.1	29.7	32.0	36.3	42.4	48.1	53.8	59.7	66.1	69.1		
3,000	29.3	34.6	36.7	41.2	48.7	56.5	64.5	72.0				
3,500	34.5	41.3	43.8	48.9	57.3	66.2	75.4					

Current consumption (for 24V applications the following must be halved) A												
rpm \ °C	-30	-25	-23.3	-20	-15	-10	-5	0	5	7.2	10	15
2,000	1.4	1.9	2.0	2.3	2.7	3.1	3.4	3.8	4.3	4.5	4.8	
2,500	1.8	2.5	2.7	3.0	3.5	4.0	4.5	5.0	5.5	5.8		
3,000	2.4	2.9	3.1	3.4	4.0	4.7	5.3	6.0				
3,500	2.9	3.4	3.6	4.1	4.8	5.5	6.3					

COP (EN 12900 Household/CECOMAF) 12V DC, static cooling W/W												
rpm \ °C	-30	-25	-23.3	-20	-15	-10	-5	0	5	7.2	10	15
2,000	0.90	1.04	1.09	1.19	1.36	1.54	1.74	1.94	2.15	2.24	2.35	
2,500	0.85	1.01	1.06	1.15	1.31	1.48	1.67	1.88	2.10	2.20		
3,000	0.76	0.95	1.01	1.12	1.28	1.45	1.64	1.85				
3,500	0.78	0.87	0.92	1.03	1.22	1.42	1.62					

COP (ASHRAE LBP) 12V DC, static cooling W/W												
rpm \ °C	-30	-25	-23.3	-20	-15	-10	-5	0	5	7.2	10	15
2,000	1.13	1.30	1.36	1.49	1.70	1.93	2.18	2.44	2.70	2.81	2.95	
2,500	1.07	1.26	1.33	1.45	1.64	1.86	2.10	2.36	2.64	2.77		
3,000	0.96	1.19	1.27	1.41	1.61	1.83	2.06	2.32				
3,500	0.98	1.09	1.15	1.29	1.53	1.78	2.03					

Test conditions with electronic units		EN 12900/CECOMAF	ASHRAE LBP
Condensing temperature	101N0242 101N0680	55°C	54.4°C
Ambient temperature		32°C	32°C
Suction gas temperature		32°C	32°C
Liquid temperature		no subcooling	32°C

Accessories for BD35F		Code number
Bolt joint for one comp.	Ø:16 mm	118-1917
Bolt joint in quantities	Ø:16 mm	118-1918
Snap-on in quantities	Ø:16 mm	118-1919
Remote kit (without cable)		105N9210
Secop Gateway		105N9518
DC usage:	Automobile fuse, DIN 7258 12V: 15A 24V: 7.5 A Main switch min. 20A	Not deliverable from Secop
AC usage:	Fuse, 100-240V Main switch min. 6A	

Compressor speed		
Electronit unit	Resistor (R1) [Ω]	Motor speed
Code number	calculated values	[rpm]
101N0242	0	2,000
101N0510	277	2,500
101N0680	692	3,000
	1523	3,500
101N0340	0	AEO
101N0420	173	2,000
with AEO	450	2,500
	865	3,000
	1696	3,500

In AEO (Adaptive Energy Optimizing) speed mode the BD compressor will always adapt its speed to the actual cooling demand.

Wire dimensions DC						
Cross section	Size		Max. length* 12V operation		Max. length* 24V operation	
	[mm²]	[Gauge]	[m]	[ft.]	[m]	[ft.]
2.5	12		2.5	8	5	16
4	12		4	13	8	26
6	10		6	20	12	39
10	8		10	33	20	66

*Length between battery and electronic unit

Wire dimensions AC
Cross section min. 0.75 mm² or AWG 18

Operational errors	
Error code or LED flashes	Error type
	Can be read out in the software TOOL4COOL®
6	Thermostat failure (If the NTC thermistor is short-circuit or has no connection).
5	Thermal cut-out of electronic unit (If the refrigeration system has been too heavily loaded, or if the ambient temperature is high, the electronic unit will run too hot).
4	Minimum motor speed error (If the refrigeration system is too heavily loaded, the motor cannot maintain minimum speed at approximately 1,850 rpm).
3	Motor start error (The rotor is blocked or the differential pressure in the refrigeration system is too high (>5 bar)).
2	Too many start attempts or fan over current (Too many compressor or fan starts in short time or fan current higher than 0.5A _{avg}).
1	Battery protection cut-out (The voltage is outside the cut-out setting).

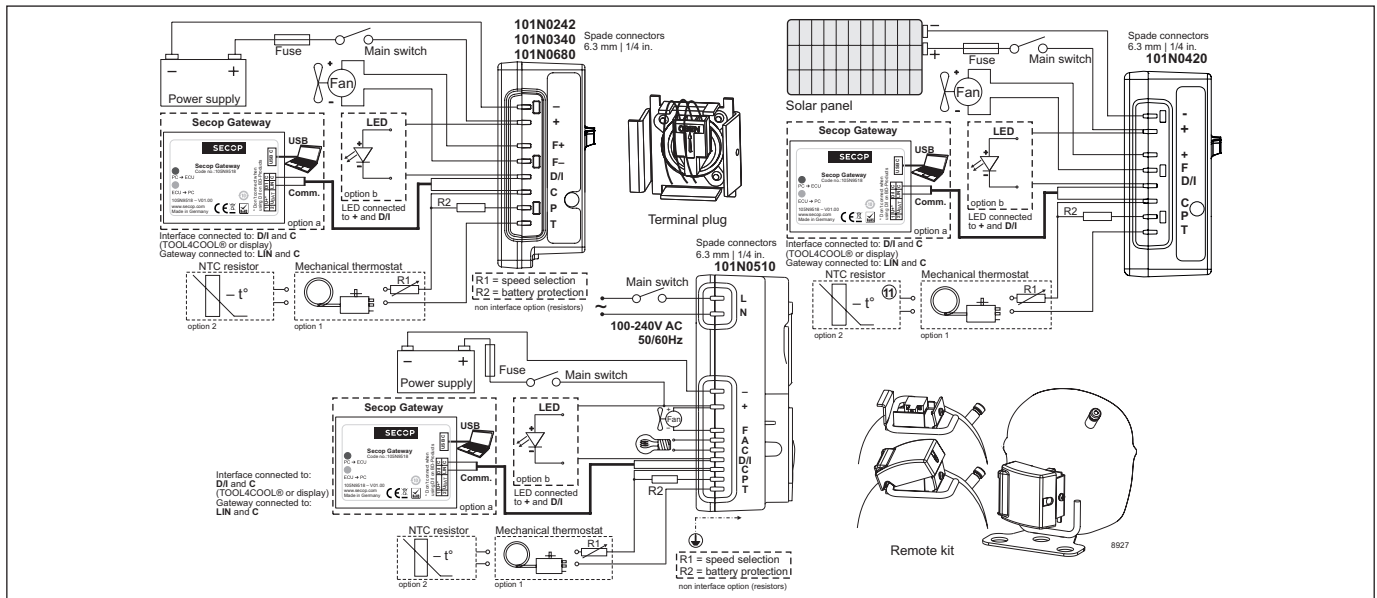

Performance Data with Refrigerant R1234yf

Capacity (EN 12900 Household/CECOMAF)		12V DC, static cooling										watt
rpm \ °C	-30	-25	-23.3	-20	-15	-10	-5	0	5	7.2	10	15
2,000	17.0	24.8	27.8	34.2	45.1	57.7	72.0	87.9	106	114	125	
2,500	18.5	29.6	33.8	42.6	57.3	73.8	92.0	111.8	133	143		
3,000	25.5	35.4	39.2	47.6	62.6	80.6	102	127				
3,500	30.3	39.3	43.4	52.6	69.9	91.1	116					

Capacity (ASHRAE LBP)		12V DC, static cooling										watt
rpm \ °C	-30	-25	-23.3	-20	-15	-10	-5	0	5	7.2	10	15
2,000	22.1	32.3	36.2	44.5	58.7	75.1	93.6	114	137	148	163	
2,500	24.1	38.5	44.0	55.3	74.4	95.7	119	145	173	186		
3,000	33.5	46.3	51.4	62.3	81.8	105	133	165				
3,500	39.4	51.3	56.6	68.7	91.3	119	152					

Power consumption		12V DC, static cooling										watt
rpm \ °C	-30	-25	-23.3	-20	-15	-10	-5	0	5	7.2	10	15
2,000	19.2	24.1	25.7	28.8	33.3	37.8	42.3	46.8	51.4	53.4	56.1	
2,500	24.0	31.4	33.7	38.1	44.4	50.3	55.8	61.0	66.0	68.2		
3,000	32.6	37.0	38.9	42.9	49.7	57.1	64.5	71.5				
3,500	38.7	44.8	47.1	51.8	59.5	67.5	75.8					

Current consumption (for 24V applications the following must be halved)		A										
rpm \ °C	-30	-25	-23.3	-20	-15	-10	-5	0	5	7.2	10	15
2,000	1.6	2.0	2.1	2.4	2.8	3.1	3.5	3.9	4.3	4.5	4.7	
2,500	2.0	2.6	2.8	3.2	3.7	4.2	4.6	5.1	5.5	5.7		
3,000	2.7	3.1	3.2	3.6	4.1	4.8	5.4	6.0				
3,500	3.2	3.7	3.9	4.3	5.0	5.6	6.3					

COP (EN 12900 Household/CECOMAF)		12V DC, static cooling										W/W
rpm \ °C	-30	-25	-23.3	-20	-15	-10	-5	0	5	7.2	10	15
2,000	0.88	1.03	1.08	1.19	1.35	1.52	1.69	1.87	2.04	2.11	2.21	
2,500	0.77	0.94	1.00	1.11	1.28	1.46	1.64	1.82	2.00	2.08		
3,000	0.78	0.95	1.01	1.11	1.25	1.41	1.57	1.77				
3,500	0.78	0.88	0.92	1.01	1.17	1.34	1.52					

COP (ASHRAE LBP)		12V DC, static cooling										W/W
rpm \ °C	-30	-25	-23.3	-20	-15	-10	-5	0	5	7.2	10	15
2,000	1.15	1.34	1.41	1.55	1.76	1.99	2.21	2.45	2.68	2.78	2.90	
2,500	1.00	1.23	1.30	1.45	1.67	1.90	2.14	2.38	2.62	2.73		
3,000	1.03	1.25	1.32	1.45	1.65	1.84	2.06	2.31				
3,500	1.02	1.15	1.20	1.33	1.54	1.76	2.00					

Test conditions with electronic units		EN 12900/CECOMAF	ASHRAE LBP
Condensing temperature	101N0242 101N0680	55°C	54.4°C
Ambient temperature		32°C	32°C
Suction gas temperature		32°C	32°C
Liquid temperature		no subcooling	32°C

Accessories for BD35F		Code number
Bolt joint for one comp.	Ø:16 mm	118-1917
Bolt joint in quantities	Ø:16 mm	118-1918
Snap-on in quantities	Ø:16 mm	118-1919
Remote kit (without cable)		105N9210
Secop Gateway		105N9518
DC usage:	Automobile fuse, DIN 7258 12V: 15A 24V: 7.5 A Main switch	Not deliverable from Secop
AC usage:	Fuse, 100-240V Main switch	

Compressor speed	Resistor (R1) [Ω]	Motor speed
Electronit unit	calculated values	[rpm]
Code number		
101N0242	0	2,000
101N0510	277	2,500
101N0680	692	3,000
	1523	3,500
101N0340	0	AEO
101N0420	173	2,000
with AEO	450	2,500
	865	3,000
	1696	3,500

In AEO (Adaptive Energy Optimizing) speed mode the BD compressor will always adapt its speed to the actual cooling demand.

Wire dimensions DC		Max. length* 12V operation		Max. length* 24V operation	
Cross section	Size				
	AWG	[m]	[ft.]	[m]	[ft.]
2.5	12	2.5	8	5	16
4	12	4	13	8	26
6	10	6	20	12	39
10	8	10	33	20	66

*Length between battery and electronic unit

Wire dimensions AC
Cross section min. 0.75 mm² or AWG 18

Operational errors		Error type
Error code or LED flashes		Can be read out in the software TOOL4COOL®
6	Thermostat failure (If the NTC thermistor is short-circuit or has no connection).	
5	Thermal cut-out of electronic unit (If the refrigeration system has been too heavily loaded, or if the ambient temperature is high, the electronic unit will run too hot).	
4	Minimum motor speed error (If the refrigeration system is too heavily loaded, the motor cannot maintain minimum speed at approximately 1,850 rpm).	
3	Motor start error (The rotor is blocked or the differential pressure in the refrigeration system is too high (>5 bar)).	
2	Too many start attempts or fan over current (Too many compressor or fan starts in short time or fan current higher than 0.5A _{avg}).	
1	Battery protection cut-out (The voltage is outside the cut-out setting).	

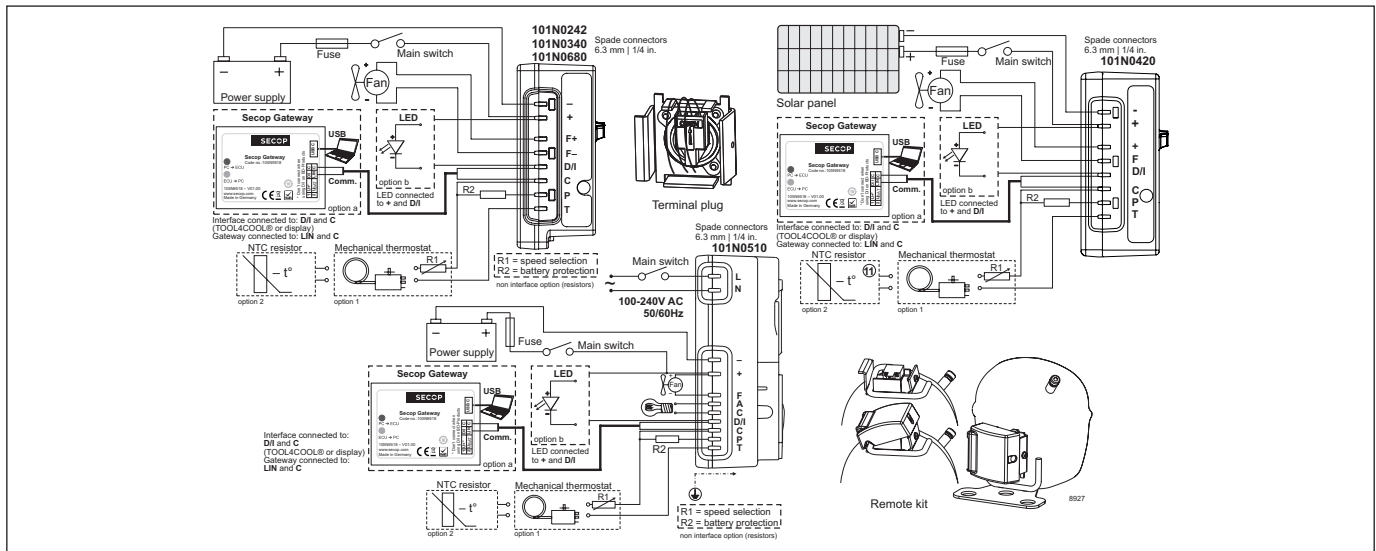

Secop accepts no responsibility for possible errors in catalogs, brochures, and other printed material. Secop reserves the right to alter its products without notice. This also applies to products already on order provided that such alterations can be made without consequential changes being necessary to specifications already agreed. All trademarks in this material are the property of the respective companies. Secop and the Secop logotype are trademarks of Secop GmbH. All rights reserved. www.secop.com



Instructions for Electronic Units
are available for download on
www.secop.com



BD Compressors



Service/Repair



8545

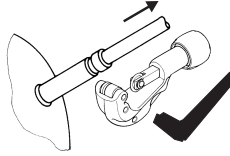

R290



R600a



R170



R1234yf

BD Nano

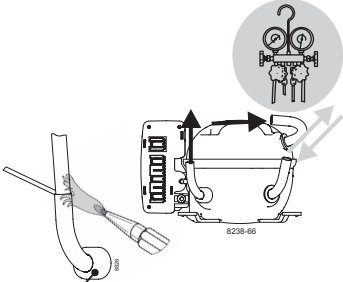

8238-66

**! max. 150°C/302°F !
at socket**

brazing solder: silver with flux

Do not heat up the bottom of the discharge
connector directly.
Do not braze longer than 10 seconds and
wait for 5 minutes for the next soldering
attempt (Product Bulletin DES.N.101.M1).

BD Micro

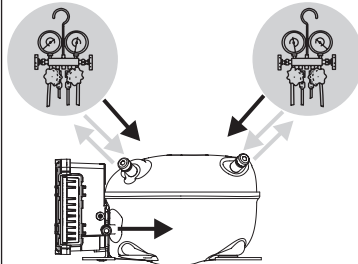

8238-47

BD P-Housing

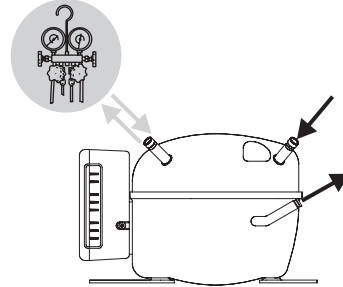

8238-31

BD T-Housing

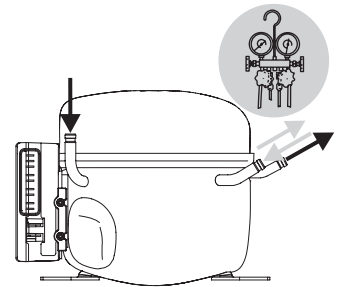

8238-48

Secop accepts no responsibility for possible errors in catalogs, brochures, and other printed material. Secop reserves the right to alter its products without notice. This also applies to products already on order provided that such alterations can be made without subsequent changes being necessary to specifications already agreed. All trademarks in this material are the property of the respective companies. Secop and the Secop logotype are trademarks of Secop GmbH. All rights reserved. www.secop.com