

Single Pack BD1.4F-VSD.2 12/24V DC PM

Single pack code number: **195B3340**

Position	Title	Code	Amount
1	Compressor BD1.4F-VSD.2	109Z0206	1
2	Electronic unit BD	101N2101	1
3	Bolt joint for one compressor M6 ø16mm	118-1917	1

Secop GmbH • Lise-Meitner-Straße 29 • 24941 Flensburg, Germany • Tel: +49 461 4941 0 • www.secop.com

Secop accepts no responsibility for possible errors in catalogs, brochures, and other printed material. Secop reserves the right to alter its products without notice. This also applies to products already on order provided that such alterations can be made without subsequent changes being necessary to specifications already agreed. All trademarks in this material are the property of the respective companies. Secop and the Secop logotype are trademarks of Secop GmbH. All rights reserved.

BD1.4F-VSD.2 Direct Current Compressor R134a, 12/24V DC



General

Code number (without electronic units)	109Z0206
Electronic unit - Variable Speed	101N2130, 30 pcs: 101N2131
Approvals	—
Compressors on pallet	180

Application

Application	LBP/MBP/HBP
Evaporating temperature °F	-20 to 59
Voltage range VDC	9.6 - 17 / 19 - 34
Max. condensing temperature continuous (short) °F	140 (158)
Max. winding temperature continuous (short) °F	257 (275)

Cooling requirements

Application	LBP	MBP	HBP
32°C	S	S	S
38°C	S	S	S
43°C	S	S	S

Remarks on application:

New generation with optimized noise level during rough vehicle motions.

Motor

Motor type	permanet magnet, brushless DC
Speed	variable speed
Resistance, all 3 windings (25°C) mΩ	210

Design

Displacement cu.in.	0.086
Oil quantity (type) fl.oz.	2.64 (polyolester)
Maximum refrigerant charge oz.	2.47
Free gas volume in compressor fl.oz.	17.60
Weight - Compressor/Electronic unit lbs.	4.63 / 0.24

Standard battery protection settings (refer to 101N2130 Instructions for optional settings)

Voltage (0.1 steps)			Min. value	Default	Max. value
12V	± 0.3V DC, all values	Cut out VDC	9.6	10.4	17
		Cut in diff. VDC	0.5	1.3	10
24V	± 0.3V DC, all values	Cut out VDC	19	21.3	27
		Cut in diff. VDC	0.5	1.3	10

Dimensions

Height	inch	A	3.79
		B	3.59
		B1	3.46
		B2	0.99
Suction connector	location/I.D. inch angle	C	0.252-0259 25°
	material comment		Cu-plated steel Al cap
Process connector	location/I.D. inch angle	D	0.252-0259 25°
	material comment		Cu-plated steel Al cap
Discharge connector	location/I.D. inch angle	E	0.202-0.205 0°
	material comment		Cu-plated steel Al cap
Remarks: inch connectors			

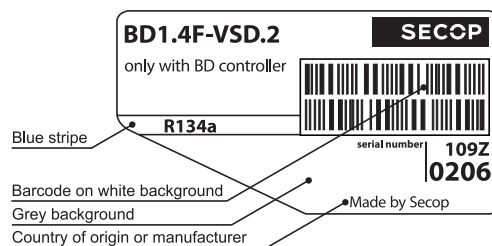

- S = Static cooling normally sufficient
- O = Oil cooling
- F₁ = Fan cooling 1.5 m/s
(compressor compartment temperature equal to ambient temperature)
- F₂ = Fan cooling 3.0 m/s necessary
- SG = Suction gas cooling normally sufficient
- = not applicable in this area

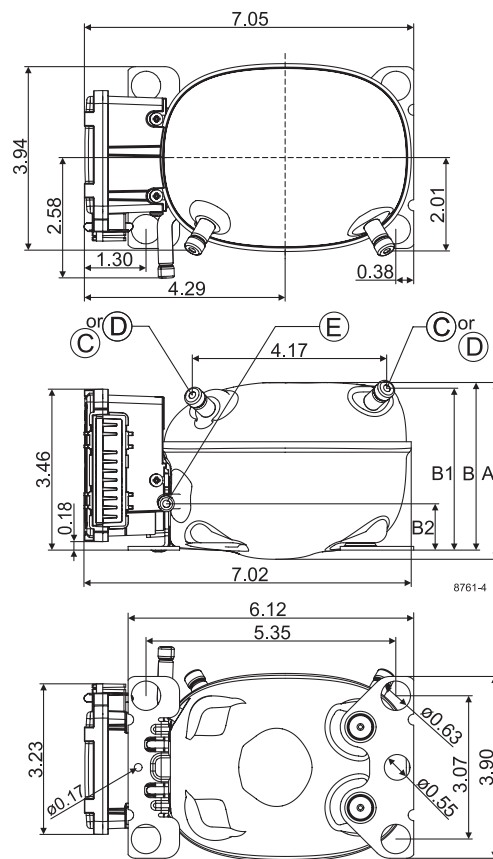

Capacity (ASHRAE LBP)

rpm \ °F	12V DC, static cooling											BTU/h
	-20	-13	-10	0	10	14	20	30	41	45	50	
2,000		39	47	77	116	133	162	219	290	319	357	431
3,000	44	69	82	130	190	217	261	344	448	488	543	648
3,500	52	83	98	156	227	258	309	406	525	573	635	756
4,000	61	98	115	182	264	300	358	468	604	657	728	865

Capacity (EN 12900 Household/CECOMAF)

rpm \ °F	12V DC, static cooling											watt
	-20	-13	-10	0	10	14	20	30	41	45	50	
2,000		9	11	18	27	31	38	51	68	75	84	101
3,000	10	16	19	31	45	51	61	81	105	115	128	152
3,500	12	20	23	37	54	61	73	96	124	135	150	178
4,000	14	23	27	43	62	71	85	110	142	155	172	203

Power consumption

rpm \ °F	12V DC, static cooling											watt
	-20	-13	-10	0	10	14	20	30	41	45	50	
2,000		16	17	20	24	25	28	33	39	41	44	50
3,000	20	24	26	31	37	39	43	49	56	59	62	68
3,500	24	29	31	37	44	47	51	58	65	68	71	78
4,000	28	34	36	44	52	55	59	67	75	77	81	87

Current consumption (for 24V applications the following must be halved)

rpm \ °F	A											
	-20	-13	-10	0	10	14	20	30	41	45	50	59
2,000		1.25	1.33	1.59	1.89	2.02	2.22	2.58	3.02	3.18	3.40	3.81
3,000	1.56	1.84	1.96	2.37	2.81	2.99	3.26	3.74	4.29	4.49	4.75	5.24
3,500	1.86	2.19	2.34	2.82	3.33	3.53	3.84	4.38	4.98	5.20	5.49	6.01
4,000	2.19	2.58	2.75	3.31	3.88	4.11	4.46	5.05	5.71	5.95	6.26	6.82

EER (ASHRAE LBP)

rpm \ °F	12V DC, static cooling											BTU/h
	-20	-13	-10	0	10	14	20	30	41	45	50	
2,000		2.51	2.83	3.87	4.89	5.27	5.83	6.69	7.54	7.82	8.16	8.73
3,000	2.15	2.87	3.18	4.17	5.15	5.53	6.09	7.03	8.03	8.38	8.83	9.61
3,500	2.17	2.89	3.19	4.17	5.14	5.52	6.09	7.05	8.10	8.47	8.95	9.81
4,000	2.18	2.89	3.19	4.15	5.12	5.50	6.07	7.04	8.12	8.52	9.03	9.95

COP (EN 12900 Household/CECOMAF)

rpm \ °F	12V DC, static cooling											W/W
	-20	-13	-10	0	10	14	20	30	41	45	50	
2,000		0.59	0.66	0.91	1.15	1.24	1.37	1.57	1.76	1.82	1.90	2.03
3,000	0.50	0.67	0.74	0.98	1.21	1.30	1.43	1.65	1.88	1.96	2.06	2.24
3,500	0.51	0.68	0.75	0.98	1.21	1.30	1.44	1.66	1.90	1.99	2.10	2.29
4,000	0.50	0.68	0.75	0.98	1.21	1.30	1.43	1.66	1.91	2.00	2.12	2.32

Operational errors (TOOL4COOL® or LED flashes)

Error code or LED flashes	Error type
	Can be read out in the software TOOL4COOL®
6	Thermostat failure (If the NTC thermistor is short-circuit or has no connection, the electronic unit will enter manual mode).
5	Thermal cut-out of electronic unit (If the refrigeration system has been too heavily loaded, or if the ambient temperature is high, the electronic unit will run too hot).
4	Minimum motor speed error (If the refrigeration system is too heavily loaded, the motor cannot maintain minimum speed at approximately 1,850 rpm).
3	Motor start error (The rotor is blocked or the differential pressure in the refrigeration system is too high (>5 bar)).
2	Fan over-current cut-out (The fan loads the electronic unit with more than 0.65A _{peak}).
1	Battery protection cut-out (The voltage is outside the cut-out setting).

Wire Dimensions DC

Cross section	Size	AWG	Max. length* 12V operation		Max. length* 24V operation	
			[mm²]	[Gauge]	[m]	[ft.]
2.5		12	2.5	8	5	16
4		12	4	13	8	26
6		10	6	20	12	39
10		8	10	33	20	66

*Length between battery and electronic unit

Accessories for BD1.4F-VSD.2

Accessories for BD1.4F-VSD.2	Code number
Bolt joint for one compressor	Ø:16 mm 118-1917
Bolt joint in quantities	Ø:16 mm 118-1918
Snap-on in quantities	Ø:16 mm 118-1919
Terminal cover for electronic unit	105N9120
Automobile fuse	12V: 15A DIN 7258
Main switch	min. 20A
	Not deliverable from Secop

Test conditions	EN 12900 CECOMAF	ASHRAE LBP
Condensing temperature	131°F	130°F
Ambient temperature	90°F	90°F
Suction gas temperature	90°F	90°F
Liquid temperature	no subcooling	90°F

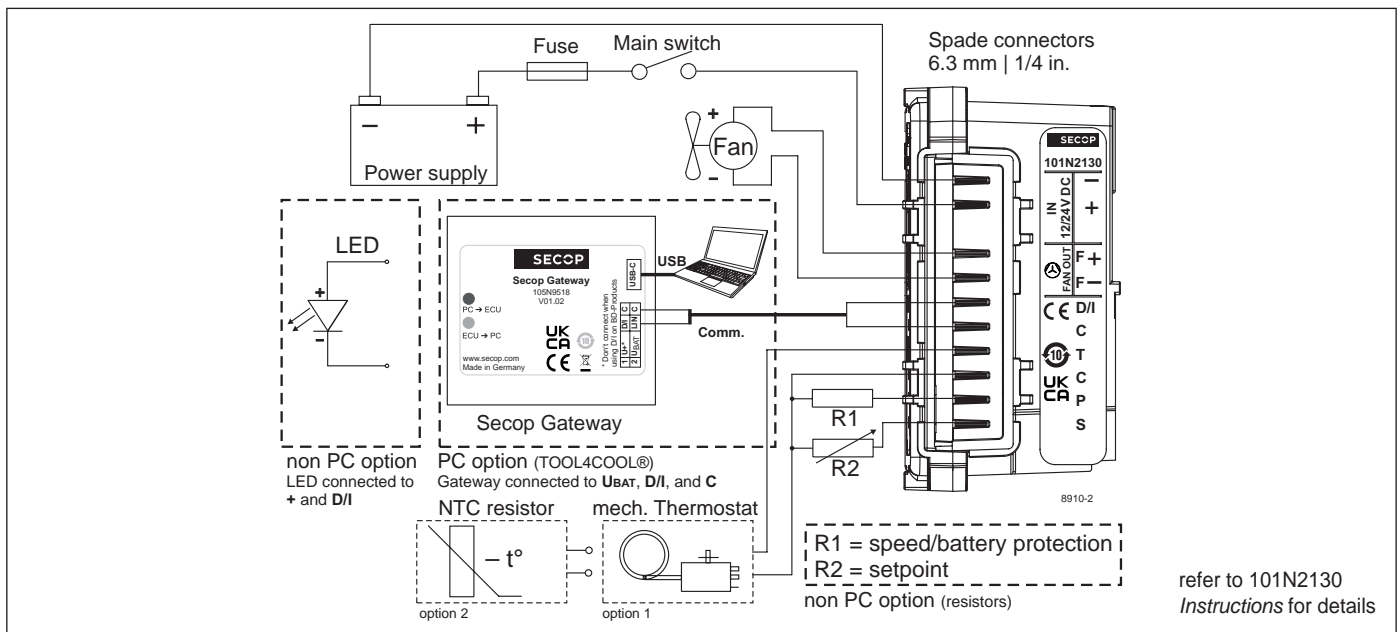

Secop accepts no responsibility for possible errors in catalogs, brochures, and other printed material. Secop reserves the right to alter its products without notice. This also applies to products already on order provided that such alterations can be made without substantial changes being necessary to specifications already agreed. All trademarks in this material are the property of the respective companies. Secop and the Secop logotype are trademarks of Secop GmbH. All rights reserved. www.secop.com



Instructions for Electronic Units
are available for download on
www.secop.com



BD Compressors

SECCP

Service/Repair

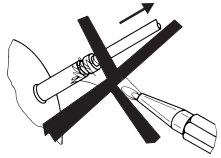

8545

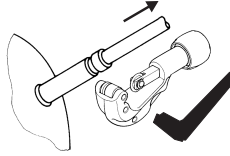

R290



R600a



R170



R1234yf



TOOL4COOL®



°CCD®

BD Nano

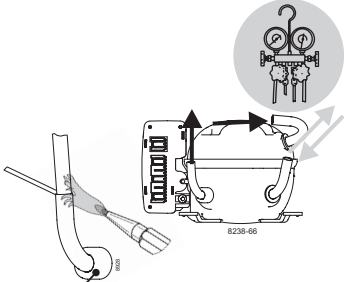

8238-66

**! max. 150°C/302°F !
at socket**

brazing solder: silver with flux

Do not heat up the bottom of the discharge
connector directly.
Do not braze longer than 10 seconds and
wait for 5 minutes for the next soldering
attempt (Product Bulletin DES.N.101.M1).

BD Micro

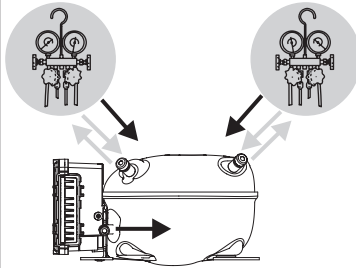

8238-47

BD P-Housing

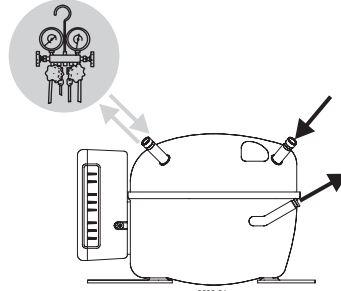

8238-31

BD T-Housing

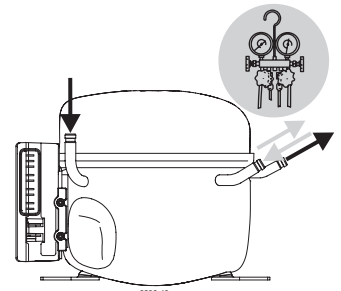

8238-48

Secop accepts no responsibility for possible errors in catalogs, brochures, and other printed material. Secop reserves the right to alter its products without notice. This also applies to products already on order provided that such alterations can be made without subsequent changes being necessary to specifications already agreed. All trademarks in this material are the property of the respective companies. Secop and the Secop logotype are trademarks of Secop GmbH. All rights reserved. www.secop.com