

Single Pack NLE10MF 220-240V 50Hz CSIR

Single pack code number: **195B4504**

Position	Title	Code	Amount
1	Compressor NLE10MF	105G6888	1
2	Starting relay	117U6003	1
3	Starting capacitor (80 μ F 220V, 6.3mm)	117U5015	1
4	Cord relief	103N1010	1
5	Cover	103N2011	1
6	Bolt joint for one compressor M6 \varnothing 16mm	118-1917	1

Secop GmbH • Lise-Meitner-Straße 29 • 24941 Flensburg, Germany • Tel: +49 461 4941 0 • www.secop.com

Secop accepts no responsibility for possible errors in catalogs, brochures, and other printed material. Secop reserves the right to alter its products without notice. This also applies to products already on order provided that such alterations can be made without subsequent changes being necessary to specifications already agreed. All trademarks in this material are the property of the respective companies. Secop and the Secop logotype are trademarks of Secop GmbH. All rights reserved.

Model

Designation	NLE10MF	220-240V/50Hz 1~	Sales code:	105G6888
-------------	----------------	-------------------------	-------------	-----------------

Compressor design

Oil type	Polyolester	Refrigerant(s)	R134a
Oil viscosity	19,2cSt	Displacement	10,09cm ³ / 0,62cu.in
Oil quantity	301cm ³ / 10,2fl.oz	Compressors on pallet	80
Refr. charge - tech. limit	400g / 14,1oz		
Free gas volume comp.	2360cm ³ / 79,8fl.oz		
Weight	10,5kg / 23,1lbs		
Motor protection	1# internal		
Winding resistance main	6,1Ω (at 25°C)		
Winding resistance aux	16Ω (at 25°C)		
Max. winding temp.	125°C / 257°F		
Max. discharge temp.	110°C / 230°F		



General - Configurations with NLE10MF

	Conf. 1	Conf. 2
Motorconfiguration	CSIR	RSIR
Power supply (nominal)	220-240V/50Hz	220-240V/50Hz
Number of phases	1	1
Voltage range	198-254V	198-254V
Approvals	VDE	VDE
Starting torque	HST	LST
Note	- / -	

Applications with NLE10MF

	Conf. 1	Conf. 2
Refrigerant	R134a	R134a
Application	LBP+MBP	LBP+MBP
System cooling	fan 1,5m/s	fan 1,5m/s
Hot gas defrost	-/-	-/-
Long interval pull down	OK	OK

Electrical data - Configurations with NLE10MF

	Conf. 1	Conf. 2
Starting device type	relay	PTC
Run capacitor	-/-	-/-
Start capacitor	80μF	-/-
LRA (locked rotor amps / 4s)	13,7A	12,1A
RLA (rated load amps / 1s)	2,5A	2,5A
Cut in current	13,7A	15,6A
IP class	21	21

Model

Designation	NLE10MF	220-240V/50Hz 1~	Sales code:	105G6888
-------------	----------------	-------------------------	-------------	-----------------

Compressor dimensions

Housing	A Height	203mm / 7,99in
	B Height	197mm / 7,76in
	C Length shell	205mm / 8,07in
	D Length w. cover	254mm / 10in
	E Width	166mm / 6,54in

Connectors		Suction	Discharge	Process
		X	Y	Z
Diameter	[mm]	øi 8,11-8,29	øi 6,11-6,29	øi 6,11-6,29
(i:inside, o:outside)	[in]	øi 0,32-0,33	øi 0,24-0,25	øi 0,24-0,25
Material		copper	copper	copper
Horizontal angle	±2°	0°	0°	0°
Vertical angle	±2°	15°	35°	155°
Position l/h/w	[mm]	126/76/78	133/103/54	-107/94/72
	[in]	5/3/3,1	5,2/4/2,1	-4,2/3,7/2,8
Straight tube l.	[mm]	12	12	12
	[in]	0,5	0,5	0,5

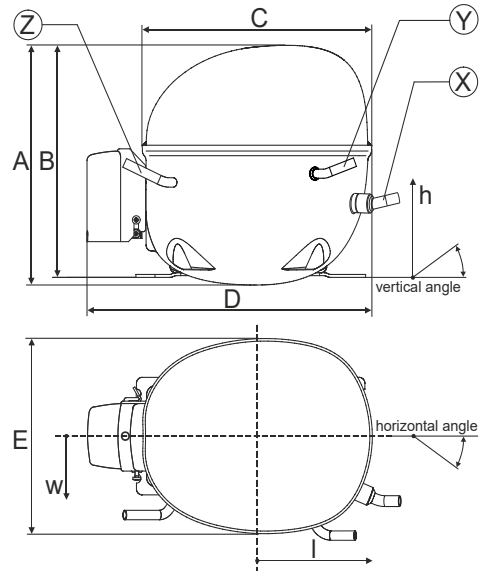

Compressor fixation

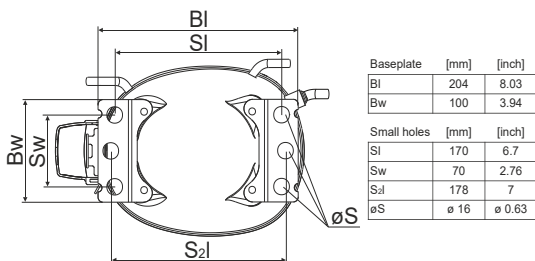

Bolt joint

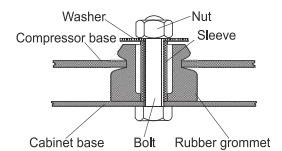

Snap-on

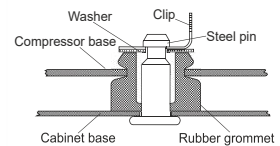

Mounting accessories

	one comp.	multi pack
Bolt joint M6 ø16mm	118-1917	118-1918
Bolt joint ø1/4" ø16mm	118-1946	
Snap-on ø7,3 ø16mm	118-1947	118-1919

Model

Designation	NLE10MF	220-240V/50Hz	Conf. 1	Sales code:	105G6888
-------------	----------------	----------------------	----------------	-------------	-----------------

Configuration

Motorconfiguration	CSIR
Power supply (nominal)	220-240V/50Hz 1~
Refrigerant	R134a
Application	LBP+MBP
Voltage range	198-254V
Starting torque	HST
Approvals	VDE

Electrical accessories / wiring diagram

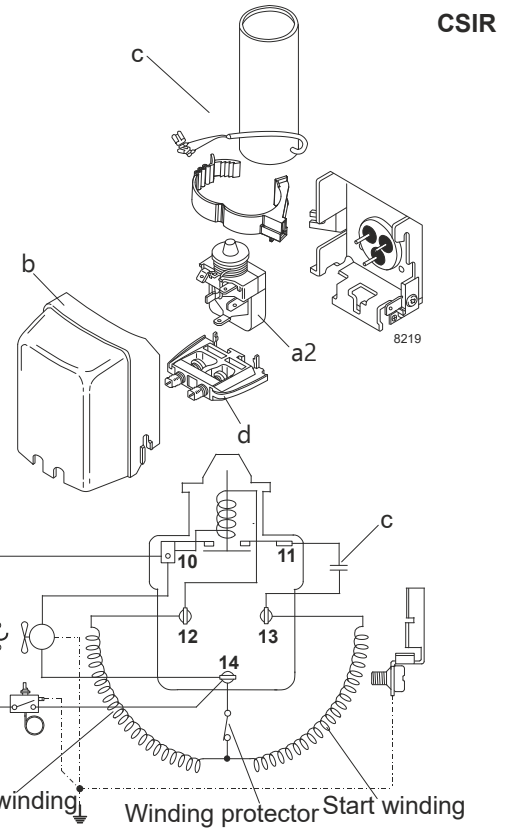

Ambient temperatures / system cooling

Ambient temperature min.:	10°C / 50°F
Ambient temperature max.:	43°C / 110°F

System cooling (n/a: outside limits)			
T ambient	LBP	MBP	HBP
32°C / 90°F	fan 1,5m/s	fan 1,5m/s	n/a
38°C / 100°F	fan 1,5m/s	fan 1,5m/s	n/a
43°C / 110°F	fan 1,5m/s	fan 1,5m/s	n/a

Operation pressure range

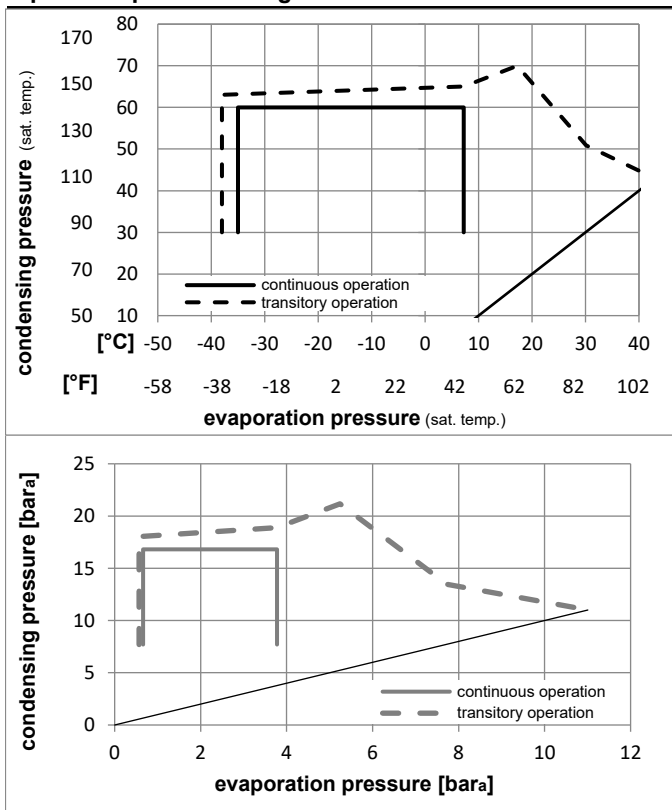

Components

a2	assy. relay	117U6003
c	start capacitor (80µF)	117U5015
b	plastic cover	103N2010
d	cord relief	103N1010

Alternative components

b	plastic cover	103N2011
---	---------------	----------

Model

Designation **NLE10MF 220-240V/50Hz** Conf. 1 Sales code: **105G6888**

Optimization + standard conditions

220-240V/50Hz 1~, CSIR, fan 1,5m/s, VDE

	Evaporating pressure (saturation temperature)				Condensing pressure (saturation temperature)						Power consumption			ASHRAE MBP
	pe	pc	RGT	Tliq	Cooling capacity			COP	EER	P1	I	Ref. mass flow		
	[°C]	[°C]	[°C]	[°C]	[W]	[Btu/h]	[kcal/h]	[W/W]	[Btu/Wh]	[kcal/Wh]	[W]	[A]	[kg/h]	
	-6,66	54,4	35	46,1	568,9	1943	489,6	1,71	5,84	1,47	332,8	2,10	12,41	ASHRAE MBP
	[°F]	20	130	95	115									
	-10	55	32	55	439,5	1501	378,3	1,43	4,87	1,23	308,0	2,00	10,63	cecomaf MBP
	[°F]	14	131	89,6	131									
	-10	45	20	45	495,8	1693	426,7	1,69	5,78	1,46	292,9	1,92	11,61	EN12900 MBP
	[°F]	14	113	68	113									
	-6,66	48,9	18,3	48,9	540,5	1846	465,2	1,68	5,73	1,44	322,3	2,05	13,35	ARI540 MBP
	[°F]	20	120	65	120									
	-10	45	32	45	514,4	1757	442,7	1,76	6,00	1,51	292,9	1,92	11,26	opt
	[°F]	14	113	89,6	113									
	-25	45	32	45	237,1	810	204,0	1,21	4,14	1,04	195,5	1,62	5,14	opt
	[°F]	-13	113	89,6	113									

Performance tables

220-240V/50Hz 1~, CSIR, fan 1,5m/s, VDE

	pe	Cooling capacity			COP	EER	P1	I	m		
	[°C]	[°F]	[W]	[Btu/h]	[kcal/h]	[W/W]	[Btu/Wh]	[kcal/Wh]	[W]	[A]	[kg/h]
[°C / °F]	-35	-31	120,6	412	103,8	0,88	3,01	0,76	136,9	1,52	2,60
cond. pressure	-25	-13	237,1	810	204,0	1,21	4,14	1,04	195,5	1,62	5,14
pc= 45/113	-15	5	405,0	1383	348,6	1,56	5,33	1,34	259,7	1,80	8,83
return gas temp.	-10	14	514,4	1757	442,7	1,76	6,00	1,51	292,9	1,92	11,26
RGT= 32/90	-5	23	643,9	2199	554,2	1,97	6,74	1,70	326,5	2,05	14,16
liquid temp	0	32	796,0	2719	685,1	2,21	7,55	1,90	360,0	2,21	17,60
Tliq= 45/113	7,2	45	1059,6	3619	911,9	2,60	8,88	2,24	407,5	2,48	23,67
[°C / °F]	-35	-31	88,0	301	75,7	0,66	2,25	0,57	133,7	1,43	2,09
cond. pressure	-25	-13	194,5	664	167,4	0,98	3,36	0,85	197,9	1,60	4,65
pc= 55/131	-15	5	343,2	1172	295,4	1,27	4,34	1,09	270,0	1,84	8,26
return gas temp	-10	14	439,5	1501	378,3	1,43	4,87	1,23	308,0	2,00	10,63
RGT= 32/90	-5	23	553,7	1891	476,5	1,60	5,45	1,37	346,9	2,17	13,46
liquid temp	0	32	688,1	2350	592,2	1,78	6,08	1,53	386,3	2,36	16,83
Tliq= 55/131	7,2	45	922,1	3149	793,6	2,08	7,11	1,79	443,1	2,67	22,81

Model

Designation	NLE10MF	220-240V/50Hz	Conf. 2	Sales code:	105G6888
-------------	----------------	----------------------	----------------	-------------	-----------------

Configuration

Motorconfiguration	RSIR
Power supply (nominal)	220-240V/50Hz 1~
Refrigerant	R134a
Application	LBP+MBP
Voltage range	198-254V
Starting torque	LST
Approvals	VDE

Electrical accessories / wiring diagram

RSIR

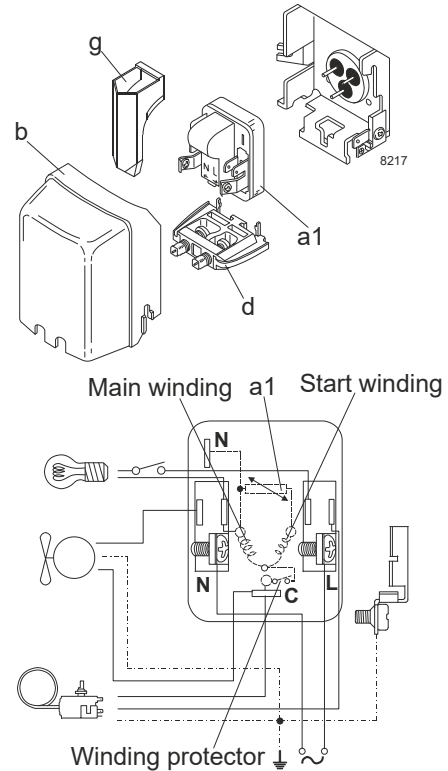

Ambient temperatures / system cooling

Ambient temperature min.:	10°C / 50°F
Ambient temperature max.:	43°C / 110°F

System cooling (n/a: outside limits)			
T ambient	LBP	MBP	HBP
32°C / 90°F	fan 1,5m/s	fan 1,5m/s	n/a
38°C / 100°F	fan 1,5m/s	fan 1,5m/s	n/a
43°C / 110°F	fan 1,5m/s	fan 1,5m/s	n/a

Operation pressure range

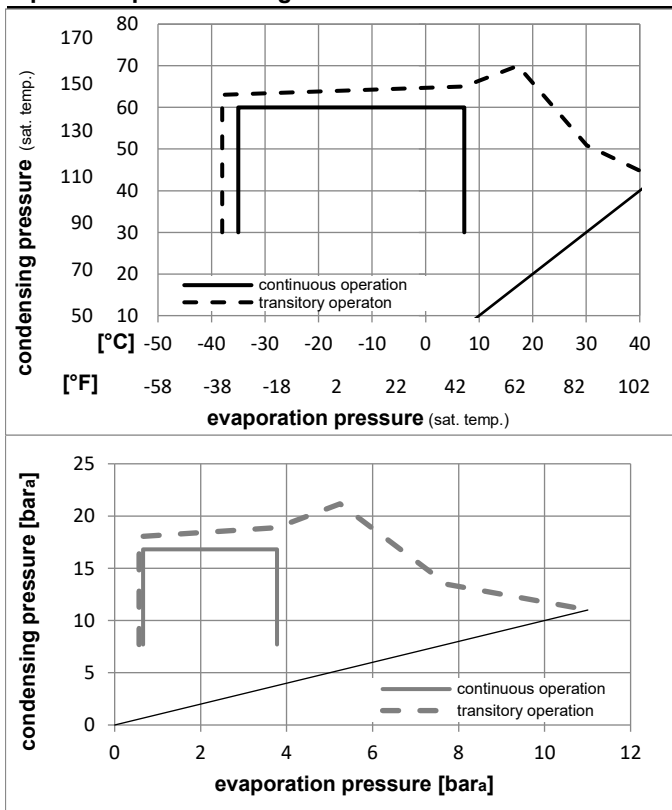

Components

a1	PTC starter (220V, 250hm, 4.8mm)	103N0018
b	plastic cover	103N2010
d	cord relief	103N1010
g	protection screen for PTC	103N0476

Alternative components

a1	PTC starter (220V, 250hm, 6.3mm)	103N0011
b	plastic cover	103N2011
d	cord relief	103N1010
g	protection screen for PTC	103N0476

Model

Designation **NLE10MF 220-240V/50Hz** Conf. **2** Sales code: **105G6888**

Optimization + standard conditions

220-240V/50Hz 1~, RSIR, fan 1,5m/s, VDE

	Evaporating pressure (saturation temperature)				Condensing pressure (saturation temperature)						Power consumption			ASHRAE MBP				
	pe	pc	RGT	Tliq	Cooling capacity			COP	EER		P1	I	Ref. mass flow					
	[°C]	[°F]	[°C]	[°F]	[W]	[Btu/h]	[kcal/h]	[W/W]	[Btu/Wh]	[kcal/Wh]	[W]	[A]	[kg/h]					
	-6,66	20	54,4	130	35	95	46,1	115	568,9	1943	489,6	1,71	5,84	1,47	332,8	2,10	12,41	
	-10	14	55	131	32	89,6	55	131	439,5	1501	378,3	1,43	4,87	1,23	308,0	2,00	10,63	cecomaf MBP
	-10	14	45	113	20	68	45	113	495,8	1693	426,7	1,69	5,78	1,46	292,9	1,92	11,61	EN12900 MBP
	-6,66	20	48,9	120	18,3	65	48,9	120	540,5	1846	465,2	1,68	5,73	1,44	322,3	2,05	13,35	ARI540 MBP
	-10	14	45	113	32	89,6	45	113	514,4	1757	442,7	1,76	6,00	1,51	292,9	1,92	11,26	opt
	-25	-13	45	113	32	89,6	45	113	237,1	810	204,0	1,21	4,14	1,04	195,5	1,62	5,14	opt

Performance tables

220-240V/50Hz 1~, RSIR, fan 1,5m/s, VDE

	pe	Cooling capacity			COP	EER		P1	I	m	
	[°C]	[°F]	[W]	[Btu/h]	[kcal/h]	[W/W]	[Btu/Wh]	[kcal/Wh]	[W]	[A]	[kg/h]
[°C / °F]	-35	-31	120,6	412	103,8	0,88	3,01	0,76	136,9	1,52	2,60
cond. pressure	-25	-13	237,1	810	204,0	1,21	4,14	1,04	195,5	1,62	5,14
pc= 45/113	-15	5	405,0	1383	348,6	1,56	5,33	1,34	259,7	1,80	8,83
return gas temp.	-10	14	514,4	1757	442,7	1,76	6,00	1,51	292,9	1,92	11,26
RGT= 32/90	-5	23	643,9	2199	554,2	1,97	6,74	1,70	326,5	2,05	14,16
liquid temp	0	32	796,0	2719	685,1	2,21	7,55	1,90	360,0	2,21	17,60
Tliq= 45/113	7,2	45	1059,6	3619	911,9	2,60	8,88	2,24	407,5	2,48	23,67
[°C / °F]	-35	-31	88,0	301	75,7	0,66	2,25	0,57	133,7	1,43	2,09
cond. pressure	-25	-13	194,5	664	167,4	0,98	3,36	0,85	197,9	1,60	4,65
pc= 55/131	-15	5	343,2	1172	295,4	1,27	4,34	1,09	270,0	1,84	8,26
return gas temp	-10	14	439,5	1501	378,3	1,43	4,87	1,23	308,0	2,00	10,63
RGT= 32/90	-5	23	553,7	1891	476,5	1,60	5,45	1,37	346,9	2,17	13,46
liquid temp	0	32	688,1	2350	592,2	1,78	6,08	1,53	386,3	2,36	16,83
Tliq= 55/131	7,2	45	922,1	3149	793,6	2,08	7,11	1,79	443,1	2,67	22,81



NL Compressors





Service/Repair – R600a, R290



8545

Brazing on Suction Connectors (Direct Intake)

representative image



**! max. 150°C/302°F !
at socket**
brazing solder: phosphor (LP7) or silver

Refer to Product Bulletin:
**Brazing on Suction Connectors
(Compressors with Direct Suction Intake)**

Secop accepts no responsibility for possible errors in catalogs, brochures, and other printed material. Secop reserves the right to alter its products without notice. This also applies to products already on order provided that such alterations can be made without subsequential changes being necessary to specifications already agreed. All trademarks in this material are the property of the respective companies. Secop and the Secop logotype are trademarks of Secop GmbH. All rights reserved. www.secop.com