

## Single Pack HTK70AA 220-240V 50Hz RSIR

Single pack code number: **195B4530**

Position	Title	Code	Amount
1	Compressor HTK70AA	16125300	1
2	Clip	10633900	4
3	Steel pin	10634100	4
4	Washer	10634300	4
5	Screw for cable clamp	10636000	1
6	Screw for cable clamp	10636200	1
7	Cover	10636401	1
8	Earth screw	10641201	1
9	Rubber grommet 16mm	11322600	4
10	Cable clamp	11341000	1
11	Terminal board 4.8mm	15163800	1

**Secop GmbH** • Lise-Meitner-Straße 29 • 24941 Flensburg, Germany • Tel: +49 461 4941 0 • [www.secop.com](http://www.secop.com)

Secop accepts no responsibility for possible errors in catalogs, brochures, and other printed material. Secop reserves the right to alter its products without notice. This also applies to products already on order provided that such alterations can be made without subsequent changes being necessary to specifications already agreed. All trademarks in this material are the property of the respective companies. Secop and the Secop logotype are trademarks of Secop GmbH. All rights reserved.

## Model

Designation	<b>HTK70AA</b>	<b>220-240V/50Hz 1~</b>	Sales code:	<b>16125300</b>
-------------	----------------	-------------------------	-------------	-----------------

## Compressor design

Oil type	Mineral	Refrigerant(s)	<b>R600a</b>
Oil viscosity	5cST	Displacement	6,6cm <sup>3</sup> / 0,4cu.in
Oil quantity	162cm <sup>3</sup> / 5,5fl.oz	Compressors on pallet	100
Refr. charge - tech. limit	150g / 5,3oz		
Free gas volume comp.	1500cm <sup>3</sup> / 50,7fl.oz		
Weight	7,9kg / 17,4lbs		
Motor protection	external		
Winding resistance main	34Ω (at 25°C)		
Winding resistance aux	15,5Ω (at 25°C)		
Max. winding temp.	130°C / 266°F		
Max. discharge temp.	130°C / 266°F		



## General - Configurations with HTK70AA

	<b>Conf. 1</b>	<b>Conf. 2</b>
Motorconfiguration	RSIR	RSCR
Power supply (nominal)	220-240V/50Hz	220-240V/50Hz
Number of phases	1	1
Voltage range	187-264V	187-264V
Approvals	VDE	VDE
Starting torque	LST	LST
Note	Various options of connectors are possible - please contact SECOP-Sales.	

## Applications with HTK70AA

	<b>Conf. 1</b>	<b>Conf. 2</b>
Refrigerant	R600a	R600a
Application	LBP	LBP
System cooling	static	static
Hot gas defrost	-/-	-/-
Long interval pull down	-/-	-/-

## Electrical data - Configurations with HTK70AA

	<b>Conf. 1</b>	<b>Conf. 2</b>
Starting device type	PTC	PTC
Run capacitor	-/-	3/4μF
Start capacitor	-/-	-/-
LRA (locked rotor amps / 4s/ U(N))		
RLA (rated load amps / 1s/ U(N))	-/-A	-/-A
Cut in current (U(N))		

## Model

Designation

**HTK70AA**

220-240V/50Hz 1~

Sales code:

**16125300**

## Compressor dimensions

Housing	A Height	166mm / 6,54in
	B Height	159mm / 6,26in
	C Length shell	194mm / 7,64in
	D Length w. cover	238mm / 9,37in
	E Width	151mm / 5,94in

Connectors		Suction	Discharge	Process
		X	Y	Z
Diameter	[mm]	øi 6,1-6,2	øi 5,1-5,2	øo 5,92-6,08
	(i:inside, o:outside) [in]	øi 0,24-0,24	øi 0,2-0,2	øo 0,23-0,24
Material		copper	copper	copper
Horizontal angle	±2°	45°	13°	0°
Vertical angle	±2°	30°	40°	145°
Position l/h/w	[mm]	120/72/62	112/106/62	-140/136/70
	[in]	4,7/2,8/2,4	4,4/4,2/2,4	-5,5/5,4/2,8
Straight tube l.	[mm]	14	14	75
	[in]	0,5	0,5	3

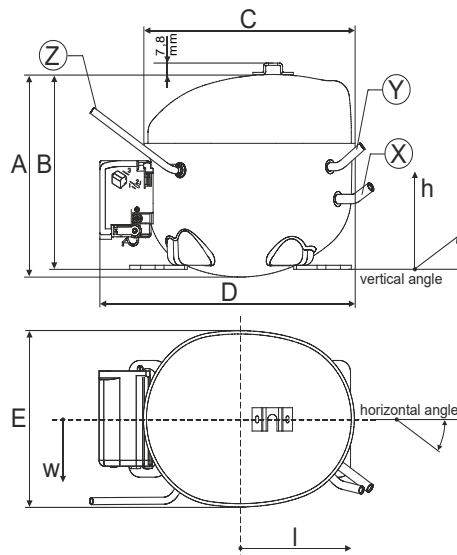

## Compressor fixation

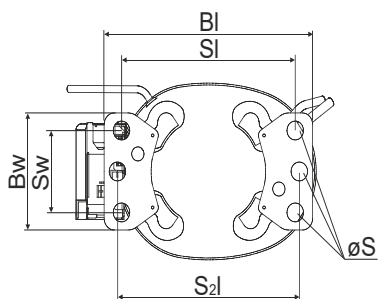

Baseplate	[mm]	[inch]
BI	204	8.03
Bw	100	3.94
Small holes		
	[mm]	[inch]
SI	170	6.7
Sw	70	2.76
S2l	178	7
øS	ø 16	ø 0.63

### Bolt joint

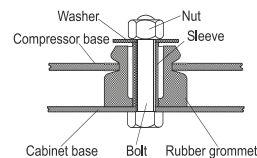

### Snap-on

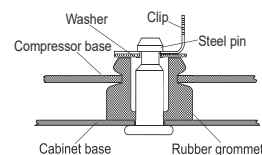

## Mounting accessories

	order code
'4ZN' with rubber grommet	772N
'4ZN' with rubber grommet and sleeve for M6	768N
Bolt joint kit	4ZN + 118-1917 (18)
'4ZN' with Snap on kit	776N

## Application notes

Provision for PE Grounding is located at the PE Stamp on the compressor Housing with dip-tray fixture (omega bracket).  
 Various options of connectors are possible - please contact SECOP-Sales.

## Model

Designation	<b>HTK70AA</b>	<b>220-240V/50Hz</b>	Conf. 1	Sales code:	<b>16125300</b>
-------------	----------------	----------------------	---------	-------------	-----------------

## Configuration

Motorconfiguration	RSIR
Power supply (nominal)	220-240V/50Hz 1~
Refrigerant	R600a
Application	LBP
Voltage range	187-264V
Starting torque	LST
Approvals	VDE

## Electrical accessories / wiring diagram

RSIR



## Ambient/ machine room temperatures minimum /maximum

Ambient temperature range:	10 - 43°C / 50 - 110°F
Machine room temperature range:	10 - 48°C / 50 - 119°F
Compressor cooling:	static



## Operation pressure range



8858-6

## Components

. terminal board (PTC, 4.8mm)	15163800
b cover terminal board	10636401
. cable clamp	11341000
. screw - uni6954	10636000
. screw - uni6954	10636200
. screw uni en iso 4757	10641201

## Alternative components

. terminal board (PTC, 6.3mm)	15162300
-------------------------------	----------

### Model

Designation	<b>HTK70AA</b>	<b>220-240V/50Hz</b>	Conf. 1	Sales code:	<b>16125300</b>
-------------	----------------	----------------------	---------	-------------	-----------------

### Optimization + standard conditions

R600a, 220V/50Hz, RSIR, static, VDE

Evaporating pressure (saturation temperature)				Condensing pressure (saturation temperature)				Power consumption				ASHRAE LBP		
Return gas temp.		Liquid temp.		Cooling capacity	COP	EER	P1	Current consumption		Ref. mass flow				
pe	pc	RGT	Tliq					[W]	[Btu/h]		[kcal/h]	[W/W]	[Btu/Wh]	[kcal/Wh]
[°C]	-23	54	32	32	116,9	399	100,6	1,61	5,50	1,39	72,6	0,42	1,25	ASHRAE LBP
[°F]	-10	130	90	90										
[°C]	-25	55	32	55	86,7	296	74,6	1,24	4,24	1,07	69,9	0,40	1,13	cecomaf LBP
[°F]	-13	131	90	131										
[°C]	-35	40	20	40	56,9	194	48,9	1,13	3,85	0,97	50,5	0,34	0,69	EN12900 LBP
[°F]	-31	104	68	104										
[°C]	-23	49	4,4	49	93,8	320	80,7	1,35	4,61	1,16	69,5	0,41	1,37	ARI540 LBP
[°F]	-10	120	40	120										
[°C]	-23	41	32	32	121,8	416	104,8	1,82	6,23	1,57	66,8	0,40	1,31	AHAM LBP
[°F]	-10	105	90	90										
[°C]	-35	45	32	45	54,0	185	46,5	1,07	3,66	0,92	50,4	0,34	0,64	opt
[°F]	-31	113	90	113										

### Performance tables

R600a, 220V/50Hz, RSIR, static, VDE

	pe		Cooling capacity			COP	EER		P1	I	m
	[°C]	[°F]	[W]	[Btu/h]	[kcal/h]	[W/W]	[Btu/Wh]	[kcal/Wh]	[W]	[A]	[kg/h]
[°C / °F]	-35	-31	54,0	185	46,5	1,07	3,66	0,92	50,4	0,34	0,64
cond. pressure	-30	-22	72,8	249	62,7	1,25	4,26	1,07	58,4	0,37	0,87
pc= 45/113	-25	-13	98,6	337	84,8	1,49	5,10	1,29	66,0	0,40	1,17
return gas temp.	-23	-10	108,7	371	93,5	1,59	5,42	1,37	68,4	0,41	1,29
RGT= 32/90	-20	-4	129,9	444	111,8	1,78	6,07	1,53	73,1	0,43	1,55
liquid temp	-15	5	165,4	565	142,3	2,07	7,09	1,79	79,7	0,46	1,98
Tliq= 45/113	-5	23	243,2	831	209,3	2,66	9,10	2,29	91,3	0,52	2,92
[°C / °F]	-35	-31	43,6	149	37,6	0,89	3,03	0,76	49,2	0,33	0,57
cond. pressure	-30	-22	62,1	212	53,4	1,04	3,54	0,89	59,9	0,37	0,81
pc= 55/131	-25	-13	86,7	296	74,6	1,24	4,24	1,07	69,9	0,40	1,13
return gas temp	-23	-10	96,2	329	82,8	1,32	4,49	1,13	73,2	0,42	1,26
RGT= 32/90	-20	-4	116,1	397	99,9	1,47	5,00	1,26	79,2	0,44	1,52
liquid temp	-15	5	149,0	509	128,2	1,70	5,79	1,46	87,9	0,48	1,95
Tliq= 55/131	-5	23	219,1	748	188,6	2,13	7,29	1,84	102,7	0,57	2,88

## Model

Designation	<b>HTK70AA</b>	<b>220-240V/50Hz</b>	<b>Conf. 2</b>	Sales code:	<b>16125300</b>
-------------	----------------	----------------------	----------------	-------------	-----------------

## Configuration

Motorconfiguration	RSCR
Power supply (nominal)	220-240V/50Hz 1~
Refrigerant	R600a
Application	LBP
Voltage range	187-264V
Starting torque	LST
Approvals	VDE

## Electrical accessories / wiring diagram

**RSCR**

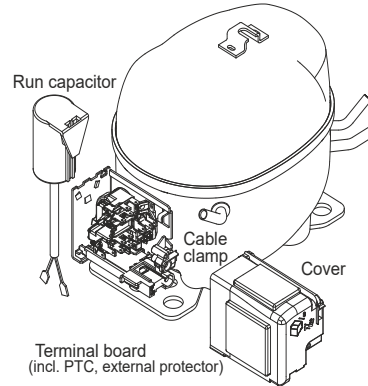

## Ambient/ machine room temperatures minimum /maximum

Ambient temperature range:	10 - 43°C / 50 - 110°F
Machine room temperature range:	10 - 48°C / 50 - 119°F
Compressor cooling:	static



## Operation pressure range

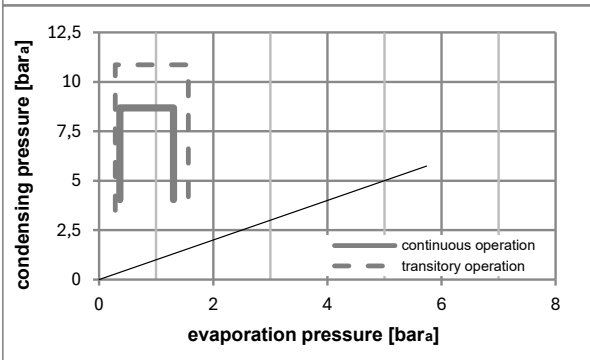
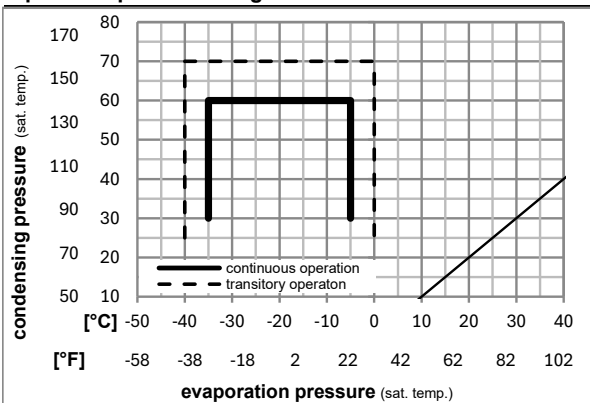

## Components

. terminal board (PTC, 4.8mm)	15163800
. run capacitor (3µF, 4.8mm)	10692902
b cover terminal board	10636401
. cable clamp	11341000
. screw - uni6954	10636000
. screw - uni6954	10636200

## Alternative components

. terminal board (PTC, 6.3mm)	15162300
. run capacitor (4µF, 6.3mm)	15186801

## Model

Designation	<b>HTK70AA</b>	<b>220-240V/50Hz</b>	<b>Conf. 2</b>	Sales code:	<b>16125300</b>
-------------	----------------	----------------------	----------------	-------------	-----------------

## Optimization + standard conditions

R600a, 220V/50Hz, RSCR, static, VDE

		Evaporating pressure (saturation temperature)				Condensing pressure (saturation temperature)			Return gas temp.		Liquid temp.		Cooling capacity			COP	EER	Power consumption			Ref. mass flow
		pe	pc	RGT	Tliq	[W]	[Btu/h]	[kcal/h]	[W/W]	[Btu/Wh]	[kcal/Wh]	P1	I	m			[W]	[A]	[kg/h]		
[°C]	[°F]	[°C]	[°F]	[°C]	[°C]																
-23	-10	54	130	32	32	116,7	399	100,5	1,66	5,68	1,43	70,2	0,31	1,25							ASHRAE LBP
-25	-13	55	131	32	55	86,6	296	74,5	1,28	4,38	1,10	67,5	0,30	1,13							cecomaf LBP
-35	-31	40	104	20	40	56,8	194	48,9	1,18	4,03	1,02	48,1	0,26	0,69							EN12900 LBP
-23	-10	49	120	4,4	49	93,7	320	80,6	1,40	4,77	1,20	67,0	0,31	1,37							ARI540 LBP
-23	-10	41	105	32	32	121,7	416	104,7	1,90	6,50	1,64	63,9	0,30	1,31							AHAM LBP
-35	-31	45	113	32	45	54,0	184	46,5	1,12	3,83	0,97	48,1	0,25	0,64							opt

## Performance tables

R600a, 220V/50Hz, RSCR, static, VDE

	pe		Cooling capacity			COP	EER		P1	I	m
	[°C]	[°F]	[W]	[Btu/h]	[kcal/h]	[W/W]	[Btu/Wh]	[kcal/Wh]	[W]	[A]	[kg/h]
[°C / °F]	-35	-31	54,0	184	46,5	1,12	3,83	0,97	48,1	0,25	0,64
cond. pressure	-30	-22	72,7	248	62,6	1,30	4,45	1,12	55,8	0,27	0,86
pc= 45/113	-25	-13	98,5	336	84,7	1,56	5,31	1,34	63,3	0,30	1,17
return gas temp.	-23	-10	108,5	371	93,4	1,65	5,64	1,42	65,7	0,31	1,29
RGT= 32/90	-20	-4	129,7	443	111,7	1,84	6,30	1,59	70,4	0,32	1,55
liquid temp	-15	5	165,2	564	142,2	2,14	7,32	1,85	77,1	0,35	1,97
Tliq= 45/113	-5	23	242,9	830	209,1	2,73	9,31	2,35	89,1	0,40	2,92
[°C / °F]	-35	-31	43,6	149	37,5	0,91	3,12	0,79	47,7	0,25	0,57
cond. pressure	-30	-22	62,0	212	53,4	1,07	3,66	0,92	57,8	0,28	0,81
pc= 55/131	-25	-13	86,6	296	74,5	1,28	4,38	1,10	67,5	0,30	1,13
return gas temp	-23	-10	96,1	328	82,7	1,36	4,64	1,17	70,7	0,31	1,25
RGT= 32/90	-20	-4	116,0	396	99,8	1,51	5,17	1,30	76,7	0,33	1,52
liquid temp	-15	5	148,8	508	128,0	1,74	5,96	1,50	85,3	0,37	1,95
Tliq= 55/131	-5	23	218,9	747	188,3	2,17	7,43	1,87	100,6	0,43	2,88



# K-Series Compressors

## GTK, HKK, HMK, HTK, HXK, HZK



### Service/Repair – R600a





# K-Series Compressors

## GTK, HKK, HMK, HTK, HXK, HZK



### Service/Repair – R600a

Secop accepts no responsibility for possible errors in catalogs, brochures, and other printed material. Secop reserves the right to alter its products without notice. This also applies to products already on order provided that such alterations can be made without subsequential changes being necessary to specifications already agreed. All trademarks in this material are the property of the respective companies. Secop and the Secop logotype are trademarks of Secop GmbH. All rights reserved. [www.secop.com](http://www.secop.com)