

## Single Pack HTK95AA 220-240V 50Hz RSCR

Single pack code number: **195B4578**

Position	Title	Code	Amount
1	Compressor HTK95AA	16068600	1
2	Clip	10633900	4
3	Steel pin	10634100	4
4	Washer	10634300	4
5	Screw for cable clamp	10636000	1
6	Screw for cable clamp	10636200	1
7	Cover	10636401	1
8	Earth screw	10641201	1
9	Run capacitor (4 $\mu$ F 400V, 4.8mm)	10693001	1
10	Rubber grommet 16mm	11322600	4
11	Cable clamp	11341000	1
12	Terminal board 4.8mm	15164300	1
13	Evaporation tray	16299100	1

Secop GmbH • Lise-Meitner-Straße 29 • 24941 Flensburg, Germany • Tel: +49 461 4941 0 • [www.secop.com](http://www.secop.com)

Secop accepts no responsibility for possible errors in catalogs, brochures, and other printed material. Secop reserves the right to alter its products without notice. This also applies to products already on order provided that such alterations can be made without subsequent changes being necessary to specifications already agreed. All trademarks in this material are the property of the respective companies. Secop and the Secop logotype are trademarks of Secop GmbH. All rights reserved.

## Model

Designation	<b>HTK95AA</b>	<b>220-240V/50Hz 1~</b>	Sales code:	<b>16068600</b>
-------------	----------------	-------------------------	-------------	-----------------

## Compressor design

Oil type	Mineral	Refrigerant(s)	<b>R600a</b>
Oil viscosity	5cST	Displacement	9,6cm <sup>3</sup> / 0,59cu.in
Oil quantity	162cm <sup>3</sup> / 5,5fl.oz	Compressors on pallet	100
Refr. charge - tech. limit	150g / 5,3oz		
Free gas volume comp.	1600cm <sup>3</sup> / 54,1fl.oz		
Weight	8,3kg / 18,3lbs		
Motor protection	external		
Winding resistance main	19,3Ω (at 25°C)		
Winding resistance aux	11,3Ω (at 25°C)		
Max. winding temp.	130°C / 266°F		
Max. discharge temp.	130°C / 266°F		



## General - Configurations with HTK95AA

	<b>Conf. 1</b>	<b>Conf. 2</b>
Motorconfiguration	RSIR	RSCR
Power supply (nominal)	220-240V/50Hz	220-240V/50Hz
Number of phases	1	1
Voltage range	187-264V	187-264V
Approvals	VDE	VDE
Starting torque	LST	LST
Note	Various options of connectors are possible - please contact SECOP-Sales.	

## Applications with HTK95AA

	<b>Conf. 1</b>	<b>Conf. 2</b>
Refrigerant	R600a	R600a
Application	LBP	LBP
System cooling	static	static
Hot gas defrost	-/-	-/-
Long interval pull down	-/-	-/-

## Electrical data - Configurations with HTK95AA

	<b>Conf. 1</b>	<b>Conf. 2</b>
Starting device type	PTC	PTC
Run capacitor	-/-	4μF
Start capacitor	-/-	-/-
LRA (locked rotor amps / 4s/ U(N))		
RLA (rated load amps / 1s/ U(N))	-/-A	-/-A
Cut in current (U(N))		

## Model

Designation	<b>HTK95AA</b>	220-240V/50Hz 1~	Sales code:	<b>16068600</b>
-------------	----------------	------------------	-------------	-----------------

## Compressor dimensions

<b>Housing</b>	A Height	174mm / 6,85in
	B Height	167mm / 6,57in
	C Length shell	194mm / 7,64in
	D Length w. cover	238mm / 9,37in
	E Width	151mm / 5,94in

<b>Connectors</b>		<b>Suction</b>	<b>Discharge</b>	<b>Process</b>
		<b>X</b>	<b>Y</b>	<b>Z</b>
Diameter	[mm]	øi 6,1-6,2	øi 5,1-5,2	øo 5,92-6,08
	(i:inside, o:outside) [in]	øi 0,24-0,24	øi 0,2-0,2	øo 0,23-0,24
Material		copper	copper	copper
Horizontal angle	±2°	45°	13°	0°
Vertical angle	±2°	30°	40°	145°
Position l/h/w	[mm]	120/72/62	112/106/62	-140/136/70
	[in]	4,7/2,8/2,4	4,4/4,2/2,4	-5,5/5,4/2,8
Straight tube l.	[mm]	14	14	75
	[in]	0,5	0,5	3

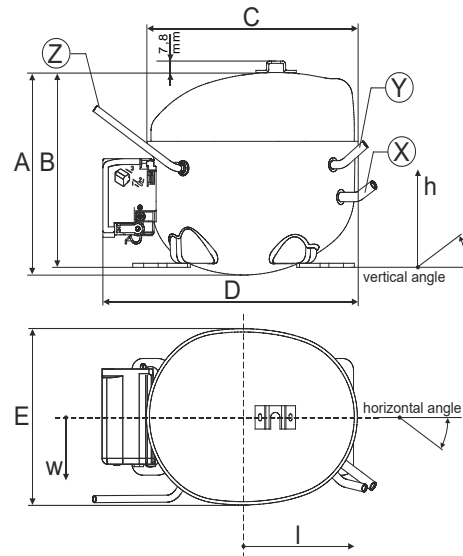

## Compressor fixation

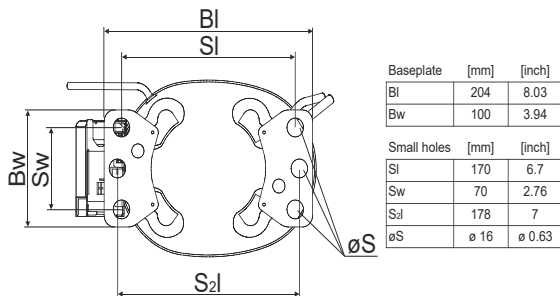

### Bolt joint

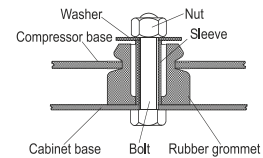

### Snap-on

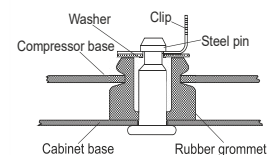

## Mounting accessories

'4ZN' with rubber grommet	order code	772N
'4ZN' with rubber grommet and sleeve for M6		768N
Bolt joint kit		4ZN + 118-1917 (18)
'4ZN' with Snap on kit		776N

## Application notes

Provision for PE Grounding is located at the PE Stamp on the compressor Housing with dip-tray fixture (omega bracket).  
 Various options of connectors are possible - please contact SECOP-Sales.

### Model

Designation	<b>HTK95AA</b>	<b>220-240V/50Hz</b>	Conf. 1	Sales code:	<b>16068600</b>
-------------	----------------	----------------------	---------	-------------	-----------------

### Configuration

Motorconfiguration	RSIR
Power supply (nominal)	220-240V/50Hz 1~
Refrigerant	R600a
Application	LBP
Voltage range	187-264V
Starting torque	LST
Approvals	VDE

### Electrical accessories / wiring diagram

RSIR



### Ambient/ machine room temperatures minimum /maximum

Ambient temperature range:	10 - 43°C / 50 - 110°F
Machine room temperature range:	10 - 48°C / 50 - 119°F
Compressor cooling:	static



### Operation pressure range

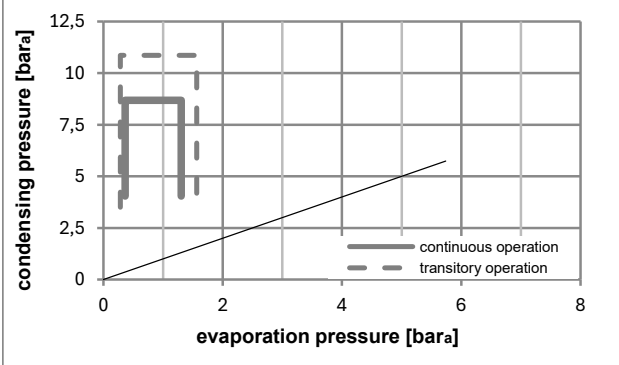
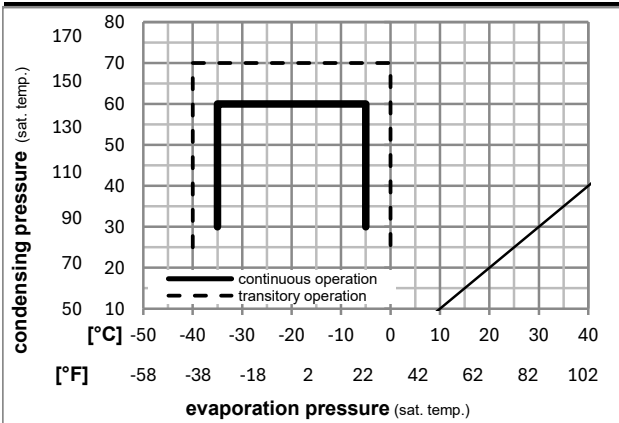

8858-6

### Components

. terminal board (PTC, 4.8mm)	15164300
b cover terminal board	10636401
. cable clamp	11341000
. screw - uni6954	10636000
. screw - uni6954	10636200
. screw uni en iso 4757	10641201

### Model

Designation	<b>HTK95AA</b>	<b>220-240V/50Hz</b>	Conf. 1	Sales code:	<b>16068600</b>
-------------	----------------	----------------------	---------	-------------	-----------------

### Optimization + standard conditions

R600a, 220V/50Hz, RSIR, static, VDE

Evaporating pressure (saturation temperature)				Condensing pressure (saturation temperature)			Power consumption				Current consumption		Ref. mass flow ṁ	
pe	pc	RGT	Tliq	[W]	[Btu/h]	[kcal/h]	COP	EER	[kcal/Wh]	P1	I	[A]		
[°C]	[°C]	[°C]	[°C]	[W]	[Btu/h]	[kcal/h]	[W/W]	[Btu/Wh]	[kcal/Wh]	[W]	[A]	[A]	[kg/h]	
-23	54	32	32	167,0	570	143,7	1,64	5,61	1,41	101,8	0,67	1,79		ASHRAE LBP
-10	130	90	90											
-25	55	32	55	125,5	429	108,0	1,28	4,38	1,10	97,8	0,65	1,64		cecomaf LBP
-13	131	90	131											
-35	40	20	40	87,1	297	74,9	1,17	3,99	1,01	74,5	0,56	1,06		EN12900 LBP
-31	104	68	104											
-23	49	4,4	49	133,7	457	115,0	1,38	4,70	1,18	97,2	0,66	1,95		ARI540 LBP
-10	120	40	120											
-23	41	32	32	173,0	591	148,9	1,89	6,47	1,63	91,3	0,65	1,86		AHAM LBP
-10	105	90	90											
-35	45	32	45	83,2	284	71,6	1,11	3,79	0,96	74,9	0,54	0,99		opt
-31	113	90	113											

### Performance tables

R600a, 220V/50Hz, RSIR, static, VDE

	pe		Cooling capacity			COP	EER	P1			I	m
	[°C]	[°F]	[W]	[Btu/h]	[kcal/h]	[W/W]	[Btu/Wh]	[kcal/Wh]	[W]	[A]	[kg/h]	
[°C / °F]	-35	-31	83,2	284	71,6	1,11	3,79	0,96	74,9	0,54	0,99	
cond. pressure	-30	-22	108,8	371	93,6	1,33	4,55	1,15	81,6	0,59	1,29	
pc= 45/113	-25	-13	141,6	483	121,8	1,56	5,33	1,34	90,8	0,64	1,69	
return gas temp.	-23	-10	154,3	527	132,8	1,64	5,59	1,41	94,3	0,66	1,84	
RGT= 32/90	-20	-4	181,6	620	156,2	1,78	6,09	1,54	101,8	0,69	2,16	
liquid temp	-15	5	228,7	781	196,9	2,01	6,85	1,73	114,0	0,74	2,73	
Tliq= 45/113	-5	23	344,6	1177	296,6	2,47	8,43	2,12	139,6	0,85	4,14	
[°C / °F]	-35	-31	70,5	241	60,6	0,93	3,17	0,80	75,9	0,53	0,92	
cond. pressure	-30	-22	94,7	323	81,5	1,11	3,78	0,95	85,7	0,59	1,23	
pc= 55/131	-25	-13	125,5	429	108,0	1,28	4,38	1,10	97,8	0,65	1,64	
return gas temp	-23	-10	137,5	469	118,3	1,34	4,59	1,16	102,3	0,67	1,79	
RGT= 32/90	-20	-4	162,8	556	140,1	1,46	4,98	1,26	111,6	0,71	2,13	
liquid temp	-15	5	206,6	706	177,8	1,63	5,58	1,41	126,5	0,78	2,71	
Tliq= 55/131	-5	23	313,7	1071	270,0	2,00	6,82	1,72	157,1	0,91	4,13	

## Model

Designation	<b>HTK95AA</b>	<b>220-240V/50Hz</b>	<b>Conf. 2</b>	Sales code:	<b>16068600</b>
-------------	----------------	----------------------	----------------	-------------	-----------------

## Configuration

Motorconfiguration	RSCR
Power supply (nominal)	220-240V/50Hz 1~
Refrigerant	R600a
Application	LBP
Voltage range	187-264V
Starting torque	LST
Approvals	VDE

## Electrical accessories / wiring diagram

**RSCR**



## Ambient/ machine room temperatures minimum /maximum

Ambient temperature range:	10 - 43°C / 50 - 110°F
Machine room temperature range:	10 - 48°C / 50 - 119°F
Compressor cooling:	static



## Operation pressure range

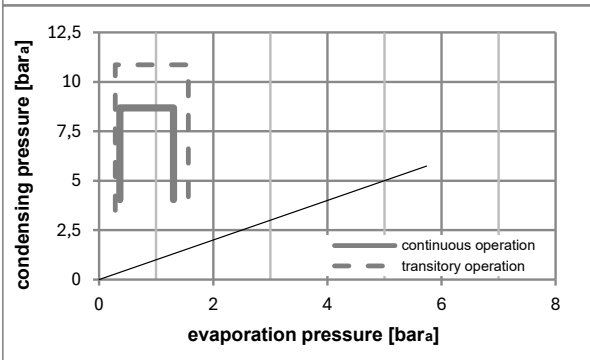
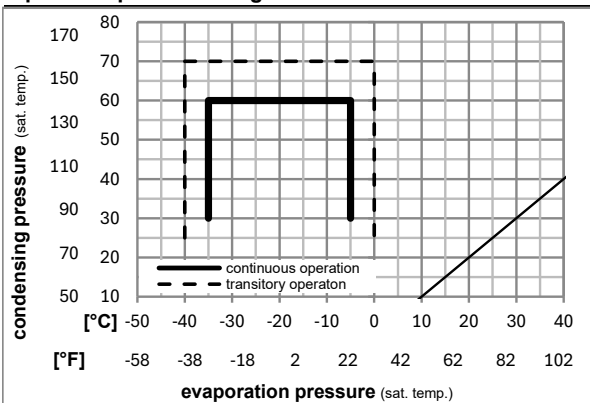

## Components

. terminal board (PTC, 4.8mm)	15164300
. run capacitor (4μF, 4.8mm)	10693001
b cover terminal board	10636401
. cable clamp	11341000
. screw - uni6954	10636000
. screw - uni6954	10636200

## Model

Designation	<b>HTK95AA</b>	<b>220-240V/50Hz</b>	<b>Conf. 2</b>	Sales code:	<b>16068600</b>
-------------	----------------	----------------------	----------------	-------------	-----------------

## Optimization + standard conditions

R600a, 220V/50Hz, RSCR, static, VDE

		Evaporating pressure (saturation temperature)				Condensing pressure (saturation temperature)						Power consumption			
		Return gas temp.		Liquid temp.		Cooling capacity		COP	EER		P1	I	Ref. mass flow		
		pe	pc	RGT	Tliq	[W]	[Btu/h]	[kcal/h]	[W/W]	[Btu/Wh]	[kcal/Wh]	[W]	[A]	[kg/h]	
[°C]	[°F]	[°C]	[°F]	[°C]	[°C]										
-23	-10	54	130	32	32	167,0	570	143,7	1,70	5,81	1,46	98,2	0,48	1,79	ASHRAE LBP
-25	-13	55	131	32	55	125,5	429	108,0	1,33	4,55	1,15	94,1	0,47	1,64	cecomaf LBP
-35	-31	40	104	20	40	87,1	297	74,9	1,22	4,16	1,05	71,4	0,40	1,06	EN12900 LBP
-23	-10	49	120	4,4	49	133,7	457	115,0	1,42	4,86	1,22	94,0	0,48	1,95	ARI540 LBP
-23	-10	41	105	32	32	173,0	591	148,9	1,95	6,66	1,68	88,7	0,47	1,86	AHAM LBP
-35	-31	45	113	32	45	83,2	284	71,6	1,16	3,98	1,00	71,5	0,39	0,99	opt

## Performance tables

R600a, 220V/50Hz, RSCR, static, VDE

	pe		Cooling capacity			COP	EER		P1	I	m
	[°C]	[°F]	[W]	[Btu/h]	[kcal/h]	[W/W]	[Btu/Wh]	[kcal/Wh]	[W]	[A]	[kg/h]
[°C / °F]	-35	-31	83,2	284	71,6	1,16	3,98	1,00	71,5	0,39	0,99
cond. pressure	-30	-22	108,8	371	93,6	1,39	4,73	1,19	78,5	0,43	1,29
pc= 45/113	-25	-13	141,6	483	121,8	1,61	5,50	1,39	87,9	0,46	1,69
return gas temp.	-23	-10	154,3	527	132,8	1,69	5,76	1,45	91,5	0,47	1,84
RGT= 32/90	-20	-4	181,6	620	156,2	1,84	6,27	1,58	98,9	0,50	2,16
liquid temp	-15	5	228,7	781	196,9	2,06	7,03	1,77	111,1	0,53	2,73
Tliq= 45/113	-5	23	344,6	1177	296,6	2,52	8,60	2,17	136,8	0,61	4,14
[°C / °F]	-35	-31	70,5	241	60,6	0,99	3,37	0,85	71,3	0,38	0,92
cond. pressure	-30	-22	94,7	323	81,5	1,16	3,96	1,00	81,7	0,42	1,23
pc= 55/131	-25	-13	125,5	429	108,0	1,33	4,55	1,15	94,1	0,47	1,64
return gas temp	-23	-10	137,5	469	118,3	1,39	4,76	1,20	98,7	0,48	1,79
RGT= 32/90	-20	-4	162,8	556	140,1	1,51	5,14	1,30	108,1	0,52	2,13
liquid temp	-15	5	206,6	706	177,8	1,68	5,73	1,44	123,1	0,56	2,71
Tliq= 55/131	-5	23	313,7	1071	270,0	2,04	6,96	1,75	154,0	0,66	4,13



# K-Series Compressors

## GTK, HKK, HMK, HTK, HXK, HZK



### Service/Repair – R600a





# K-Series Compressors

## GTK, HKK, HMK, HTK, HXK, HZK



### Service/Repair – R600a

Secop accepts no responsibility for possible errors in catalogs, brochures, and other printed material. Secop reserves the right to alter its products without notice. This also applies to products already on order provided that such alterations can be made without subsequential changes being necessary to specifications already agreed. All trademarks in this material are the property of the respective companies. Secop and the Secop logotype are trademarks of Secop GmbH. All rights reserved. [www.secop.com](http://www.secop.com)