

## Single Pack HTK12AA 220-240V 50Hz RSCR

Single pack code number: **195B4580**

Position	Title	Code	Amount
1	Compressor HTK12AA	16111600	1
2	Clip	10633900	4
3	Steel pin	10634100	4
4	Washer	10634300	4
5	Screw for cable clamp	10636000	1
6	Screw for cable clamp	10636200	1
7	Cover	10636401	1
8	Earth screw	10641201	1
9	Run capacitor (4 $\mu$ F 400V, 4.8mm)	10693001	1
10	Rubber grommet 16mm	11322600	4
11	Cable clamp	11341000	1
12	Terminal board 4.8mm	15164000	1
13	Evaporation tray	16299100	1

Secop GmbH • Lise-Meitner-Straße 29 • 24941 Flensburg, Germany • Tel: +49 461 4941 0 • [www.secop.com](http://www.secop.com)

Secop accepts no responsibility for possible errors in catalogs, brochures, and other printed material. Secop reserves the right to alter its products without notice. This also applies to products already on order provided that such alterations can be made without subsequent changes being necessary to specifications already agreed. All trademarks in this material are the property of the respective companies. Secop and the Secop logotype are trademarks of Secop GmbH. All rights reserved.

## Model

Designation	<b>HTK12AA</b>	<b>220-240V/50Hz 1~</b>	Sales code:	<b>16111600</b>
-------------	----------------	-------------------------	-------------	-----------------

## Compressor design

Oil type	Mineral	Refrigerant(s)	<b>R600a</b>
Oil viscosity	5cST	Displacement	11,2cm <sup>3</sup> / 0,68cu.in
Oil quantity	162cm <sup>3</sup> / 5,5fl.oz	Compressors on pallet	100
Refr. charge - tech. limit	150g / 5,3oz		
Free gas volume comp.	1660cm <sup>3</sup> / 56,1fl.oz		
Weight	8,5kg / 18,7lbs		
Motor protection	external		
Winding resistance main	14,6Ω (at 25°C)		
Winding resistance aux	13,7Ω (at 25°C)		
Max. winding temp.	130°C / 266°F		
Max. discharge temp.	130°C / 266°F		



## General - Configurations with HTK12AA

	<b>Conf. 1</b>	<b>Conf. 2</b>
Motorconfiguration	RSIR	RSCR
Power supply (nominal)	220-240V/50Hz	220-240V/50Hz
Number of phases	1	1
Voltage range	187-264V	187-264V
Approvals	VDE	VDE
Starting torque	LST	LST
Note	Various options of connectors are possible - please contact SECOP-Sales.	

## Applications with HTK12AA

	<b>Conf. 1</b>	<b>Conf. 2</b>
Refrigerant	R600a	R600a
Application	LBP	LBP
System cooling	static	static
Hot gas defrost	-/-	-/-
Long interval pull down	-/-	-/-

## Electrical data - Configurations with HTK12AA

	<b>Conf. 1</b>	<b>Conf. 2</b>
Starting device type	PTC	PTC
Run capacitor	-/-	4μF
Start capacitor	-/-	-/-
LRA (locked rotor amps / 4s/ U(N))		
RLA (rated load amps / 1s/ U(N))	-/-A	
Cut in current (U(N))		

## Model

Designation	<b>HTK12AA</b>	<b>220-240V/50Hz 1~</b>	Sales code:	<b>16111600</b>
-------------	----------------	-------------------------	-------------	-----------------

## Compressor dimensions

<b>Housing</b>	A Height	174mm / 6,85in
	B Height	167mm / 6,57in
	C Length shell	194mm / 7,64in
	D Length w. cover	238mm / 9,37in
	E Width	151mm / 5,94in

<b>Connectors</b>		<b>Suction</b>	<b>Discharge</b>	<b>Process</b>
		<b>X</b>	<b>Y</b>	<b>Z</b>
Diameter	[mm]	øi 6,1-6,2	øi 5,1-5,2	øo 5,92-6,08
	(i:inside, o:outside) [in]	øi 0,24-0,24	øi 0,2-0,2	øo 0,23-0,24
Material		copper	copper	copper
Horizontal angle	±2°	45°	13°	0°
Vertical angle	±2°	30°	40°	145°
Position l/h/w	[mm]	120/72/62	112/106/62	-140/136/70
	[in]	4,7/2,8/2,4	4,4/4,2/2,4	-5,5/5,4/2,8
Straight tube l.	[mm]	14	14	75
	[in]	0,5	0,5	3



## Compressor fixation

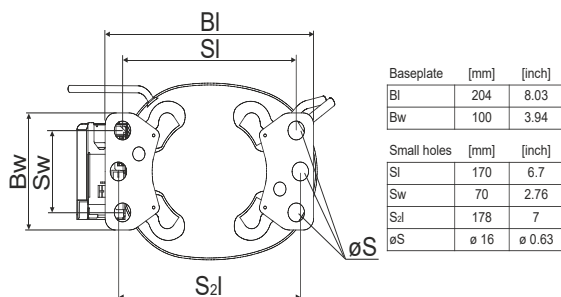

### Bolt joint



### Snap-on

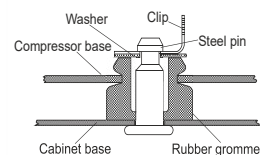

## Mounting accessories

	order code
'4ZN' with rubber grommet	772N
'4ZN' with rubber grommet and sleeve for M6	768N
Bolt joint kit	4ZN + 118-1917 (18)
'4ZN' with Snap on kit	776N

## Application notes

- Provision for PE Grounding is located at the PE Stamp on the compressor Housing with dip-tray fixture (omega bracket).
- Various options of connectors are possible - please contact SECOP-Sales.

### Model

Designation	<b>HTK12AA</b>	<b>220-240V/50Hz</b>	Conf. 1	Sales code:	<b>16111600</b>
-------------	----------------	----------------------	---------	-------------	-----------------

### Configuration

Motorconfiguration	RSIR
Power supply (nominal)	220-240V/50Hz 1~
Refrigerant	R600a
Application	LBP
Voltage range	187-264V
Starting torque	LST
Approvals	VDE

### Electrical accessories / wiring diagram

RSIR



### Ambient/ machine room temperatures minimum /maximum

Ambient temperature range:	10 - 43°C / 50 - 110°F
Machine room temperature range:	10 - 48°C / 50 - 119°F
Compressor cooling:	static



### Operation pressure range

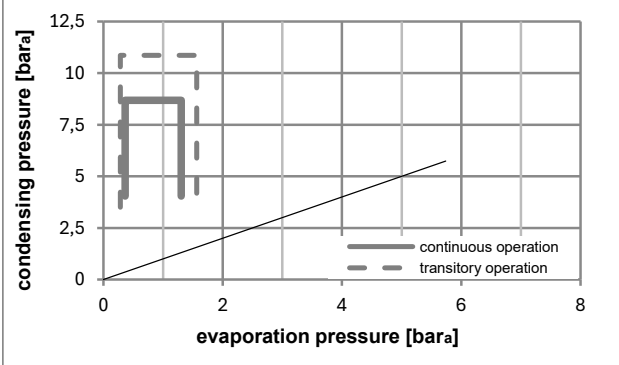
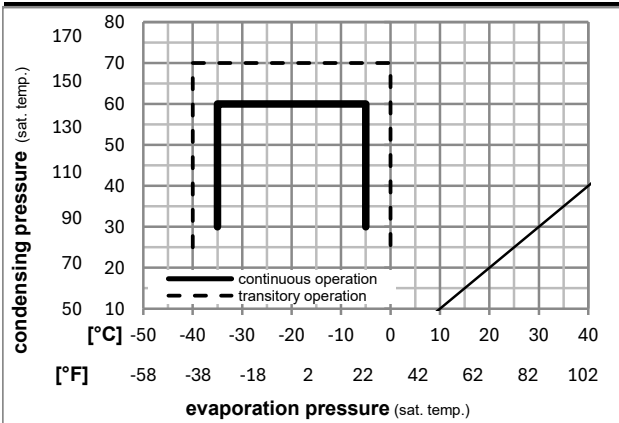

8858-6

### Components

. terminal board (PTC, 4.8mm)	15164000
b cover terminal board	10636401
. cable clamp	11341000
. screw - uni6954	10636000
. screw - uni6954	10636200
. screw uni en iso 4757	10641201

### Alternative components

. terminal board (PTC, 6.3mm)	15162500
-------------------------------	----------

### Model

Designation	<b>HTK12AA</b>	<b>220-240V/50Hz</b>	Conf. 1	Sales code:	<b>16111600</b>
-------------	----------------	----------------------	---------	-------------	-----------------

### Optimization + standard conditions

R600a, 220V/50Hz, RSIR, static, VDE

		Evaporating pressure (saturation temperature)				Condensing pressure (saturation temperature)			Return gas temp.		Liquid temp.		Cooling capacity			COP	EER	Power consumption		Current consumption		Ref. mass flow	
		pe	pc	RGT	Tliq	[W]	[Btu/h]	[kcal/h]	[W/W]	[Btu/W/h]	[kcal/W/h]	[W]	[A]	[kg/h]			P1	I	m				
[°C]	[°F]	[°C]	[°F]	[°C]	[°F]																		
-23	-10	54	130	32	90	197,8	675	170,2	1,63	5,58	1,41	121,0	0,87	2,12								ASHRAE LBP	
-25	-13	55	131	32	90	149,0	509	128,2	1,28	4,39	1,11	116,0	0,85	1,94								cecomaf LBP	
-35	-31	40	104	20	68	96,0	328	82,6	1,15	3,94	0,99	83,3	0,72	1,17								EN12900 LBP	
-23	-10	49	120	4,4	40	159,2	544	137,0	1,34	4,59	1,16	118,5	0,86	2,33								ARI540 LBP	
-23	-10	41	105	32	90	207,3	708	178,4	1,81	6,17	1,55	114,8	0,84	2,22								AHAM LBP	
-35	-31	45	113	32	90	93,3	319	80,3	1,11	3,79	0,95	84,1	0,71	1,11								opt	

### Performance tables

R600a, 220V/50Hz, RSIR, static, VDE

	pe		Cooling capacity			COP	EER	P1	I	m	
	[°C]	[°F]	[W]	[Btu/h]	[kcal/h]	[W/W]	[Btu/W/h]	[kcal/W/h]	[W]	[A]	[kg/h]
[°C / °F]	-35	-31	93,3	319	80,3	1,11	3,79	0,95	84,1	0,71	1,11
cond. pressure	-30	-22	128,6	439	110,7	1,31	4,48	1,13	98,1	0,77	1,53
pc= 45/113	-25	-13	169,4	578	145,8	1,51	5,16	1,30	112,1	0,83	2,02
return gas temp.	-23	-10	184,4	630	158,7	1,58	5,39	1,36	116,8	0,85	2,20
RGT= 32/90	-20	-4	215,5	736	185,5	1,71	5,84	1,47	126,0	0,89	2,57
liquid temp	-15	5	267,0	912	229,8	1,91	6,52	1,64	139,8	0,96	3,19
Tliq= 45/113	-5	23	385,7	1317	331,9	2,31	7,89	1,99	166,9	1,10	4,63
[°C / °F]	-35	-31	81,6	279	70,3	0,96	3,28	0,83	84,9	0,69	1,06
cond. pressure	-30	-22	112,5	384	96,8	1,12	3,83	0,97	100,3	0,76	1,47
pc= 55/131	-25	-13	149,0	509	128,2	1,28	4,39	1,11	116,0	0,85	1,94
return gas temp	-23	-10	162,7	556	140,0	1,34	4,57	1,15	121,4	0,87	2,12
RGT= 32/90	-20	-4	191,0	652	164,4	1,45	4,94	1,24	132,1	0,93	2,50
liquid temp	-15	5	238,4	814	205,2	1,60	5,48	1,38	148,5	1,01	3,12
Tliq= 55/131	-5	23	349,4	1193	300,7	1,92	6,55	1,65	182,3	1,18	4,60

## Model

Designation	<b>HTK12AA</b>	<b>220-240V/50Hz</b>	<b>Conf. 2</b>	Sales code:	<b>16111600</b>
-------------	----------------	----------------------	----------------	-------------	-----------------

## Configuration

Motorconfiguration	RSCR
Power supply (nominal)	220-240V/50Hz 1~
Refrigerant	R600a
Application	LBP
Voltage range	187-264V
Starting torque	LST
Approvals	VDE

## Electrical accessories / wiring diagram

**RSCR**

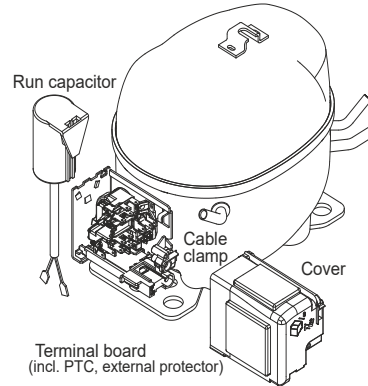

## Ambient/ machine room temperatures minimum /maximum

Ambient temperature range:	10 - 43°C / 50 - 110°F
Machine room temperature range:	10 - 48°C / 50 - 119°F
Compressor cooling:	static



## Operation pressure range

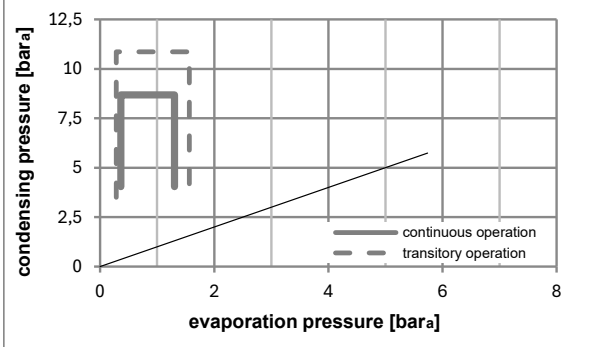
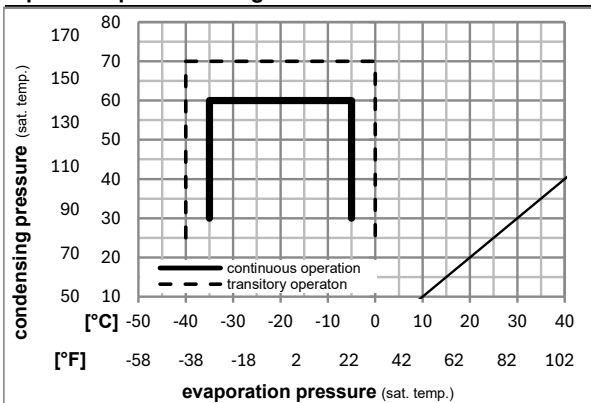

## Components

. terminal board (PTC, 4.8mm)	15164000
. run capacitor (4μF, 4.8mm)	10693001
b cover terminal board	10636401
. cable clamp	11341000
. screw - uni6954	10636000
. screw - uni6954	10636200

## Alternative components

. terminal board (PTC, 6.3mm)	15162500
. run capacitor (4μF, 6.3mm)	15186801
. screw uni en iso 4757	10641201

## Model

Designation	<b>HTK12AA</b>	<b>220-240V/50Hz</b>	<b>Conf. 2</b>	Sales code:	<b>16111600</b>
-------------	----------------	----------------------	----------------	-------------	-----------------

## Optimization + standard conditions

R600a, 220V/50Hz, RSCR, static, VDE

	Evaporating pressure (saturation temperature)				Cooling capacity			COP	EER	P1	Power consumption		Ref. mass flow	
	pe	pc	RGT	Tliq	[W]	[Btu/h]	[kcal/h]				[W]	[A]		
[°C]	-23	54	32	32	197,8	675	170,2	1,70	5,81	1,46	116,3	0,65	2,12	<b>ASHRAE LBP</b>
[°F]	-10	130	90	90										
[°C]	-25	55	32	55	149,0	509	128,2	1,34	4,57	1,15	111,4	0,63	1,94	<b>cecomaf LBP</b>
[°F]	-13	131	90	131										
[°C]	-35	40	20	40	96,0	328	82,6	1,22	4,17	1,05	78,6	0,54	1,17	<b>EN12900 LBP</b>
[°F]	-31	104	68	104										
[°C]	-23	49	4,4	49	159,2	544	137,0	1,40	4,78	1,20	113,8	0,64	2,33	<b>ARI540 LBP</b>
[°F]	-10	120	40	120										
[°C]	-23	41	32	32	207,3	708	178,4	1,88	6,41	1,62	110,4	0,63	2,22	<b>AHAM LBP</b>
[°F]	-10	105	90	90										
[°C]	-35	45	32	45	93,3	319	80,3	1,18	4,02	1,01	79,2	0,53	1,11	<b>opt</b>
[°F]	-31	113	90	113										

## Performance tables

R600a, 220V/50Hz, RSCR, static, VDE

	pe		Cooling capacity			COP	EER	P1	I	m	
	[°C]	[°F]	[W]	[Btu/h]	[kcal/h]						
[°C / °F]	-35	-31	93,3	319	80,3	1,18	4,02	1,01	79,2	0,53	1,11
cond. pressure	-30	-22	128,6	439	110,7	1,38	4,70	1,19	93,4	0,57	1,53
pc= 45/113	-25	-13	169,4	578	145,8	1,58	5,38	1,36	107,5	0,62	2,02
return gas temp.	-23	-10	184,4	630	158,7	1,64	5,61	1,41	112,2	0,64	2,20
RGT= 32/90	-20	-4	215,5	736	185,5	1,77	6,06	1,53	121,4	0,67	2,57
liquid temp	-15	5	267,0	912	229,8	1,97	6,74	1,70	135,2	0,72	3,19
Tliq= 45/113	-5	23	385,7	1317	331,9	2,38	8,12	2,05	162,1	0,82	4,63
[°C / °F]	-35	-31	81,6	279	70,3	1,01	3,45	0,87	80,8	0,51	1,06
cond. pressure	-30	-22	112,5	384	96,8	1,17	4,01	1,01	95,9	0,57	1,47
pc= 55/131	-25	-13	149,0	509	128,2	1,34	4,57	1,15	111,4	0,63	1,94
return gas temp	-23	-10	162,7	556	140,0	1,39	4,76	1,20	116,7	0,65	2,12
RGT= 32/90	-20	-4	191,0	652	164,4	1,50	5,13	1,29	127,1	0,69	2,50
liquid temp	-15	5	238,4	814	205,2	1,67	5,69	1,43	143,1	0,75	3,12
Tliq= 55/131	-5	23	349,4	1193	300,7	1,99	6,80	1,71	175,4	0,88	4,60



# K-Series Compressors

## GTK, HKK, HMK, HTK, HXK, HZK



**Service/Repair – R600a**





# K-Series Compressors

## GTK, HKK, HMK, HTK, HXK, HZK

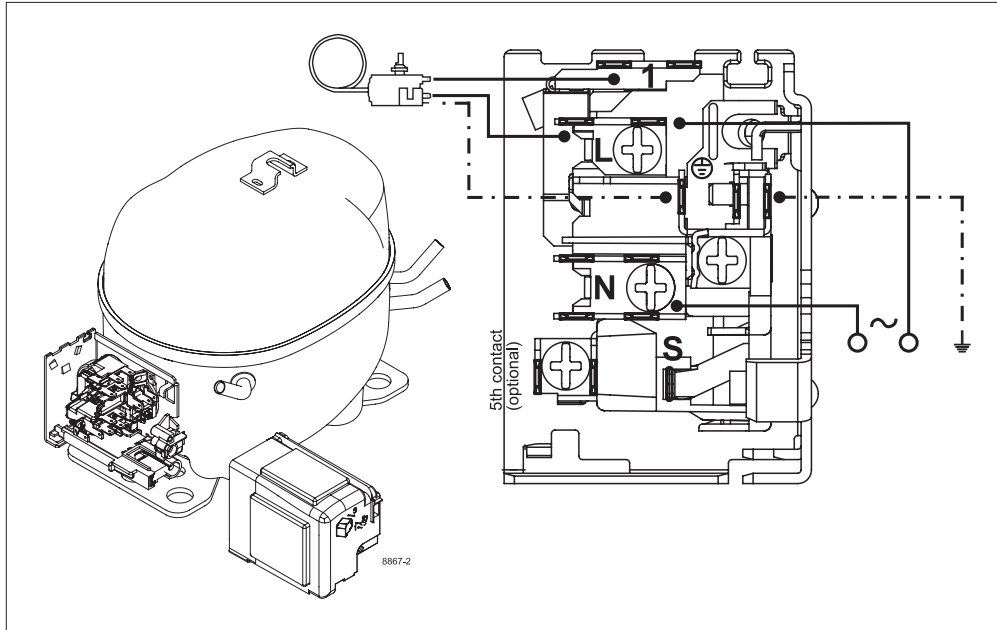

### Service/Repair – R600a

Secop accepts no responsibility for possible errors in catalogs, brochures, and other printed material. Secop reserves the right to alter its products without notice. This also applies to products already on order provided that such alterations can be made without subsequential changes being necessary to specifications already agreed. All trademarks in this material are the property of the respective companies. Secop and the Secop logotype are trademarks of Secop GmbH. All rights reserved. [www.secop.com](http://www.secop.com)