

Single Pack SC21CL 220-240V 50Hz CSCR

Single pack code number: **195B4584**

Position	Title	Code	Amount
1	Compressor SC21CL	104L2322	1
2	SC starting device (650mm)	117-7046	1
3	Cord relief	103N1004	1
4	Cover	103N2009	1
5	Bolt joint for one compressor M6 ø16mm	118-1917	1

Model

Designation	SC21CL	220-240V/50Hz 1~	Sales code:	104L2322
-------------	---------------	------------------	-------------	-----------------

Compressor design

Oil type	Polyolester	Refrigerant(s)	R404A, R452A, R507
Oil viscosity	32,5cST	Displacement	20,95cm ³ / 1,28cu.in
Oil quantity	544cm ³ / 18,4fl.oz	Compressors on pallet	80
Refr. charge - tech. limit	1300g / 45,9oz		
Free gas volume comp.	1410cm ³ / 47,7fl.oz		
Weight	14,1kg / 31,1lbs		
Motor protection	1# internal		
Winding resistance main	3,4Ω (at 25°C)		
Winding resistance aux	14,4Ω (at 25°C)		
Max. winding temp.	125°C / 257°F		
Max. discharge temp.	130°C / 266°F		



General - Configurations with SC21CL

	Conf. 1	Conf. 2
Motorconfiguration	CSCR	CSCR
Power supply (nominal)	220-240V/50Hz	220-240V/50Hz
Number of phases	1	1
Voltage range	198-254V	198-254V
Approvals	VDE, CCC, EAC	VDE, CCC
Starting torque	HST	HST
Note	- / -	

Applications with SC21CL

	Conf. 1	Conf. 2
Refrigerant	R404A	R452A
Application	LBP	LBP
System cooling	fan 3m/s	fan 3m/s
Hot gas defrost	OK	OK
Long interval pull down	OK	OK

Electrical data - Configurations with SC21CL

	Conf. 1	Conf. 2
Starting device type	relay	relay
Run capacitor	10μF	10μF
Start capacitor	80μF	80μF
LRA (locked rotor amps / 4s)	23,4A	23,4A
RLA (rated load amps / 1s)	4,3A	4,3A
Cut in current	23,4A	23,4A

Model

Designation

SC21CL

220-240V/50Hz 1~

Sales code:

104L2322

Compressor dimensions

Housing	A Height	219mm / 8,62in
	B Height	213mm / 8,39in
	C Length shell	239mm / 9,41in
	D Length w. cover	255mm / 10,04in
	E Width	151mm / 5,94in

Connectors	Suction X	Discharge Y	Process Z
Diameter [mm]	øi 10,11-10,29	øi 6,11-6,29	øi 6,11-6,29
(i:inside, o:outside) [in]	øi 0,4-0,41	øi 0,24-0,25	øi 0,24-0,25
Material	copper	copper	copper
Horizontal angle ±2°	37°	37°	143°
Vertical angle ±2°	30°	0°	150°
Position l/h/w [mm]	107/193/55	115/110/63	-107/193/55
[in]	4,2/7,6/2,2	4,5/4,3/2,5	-4,2/7,6/2,2
Straight tube l. [mm]	12	12	12
[in]	0,5	0,5	0,5

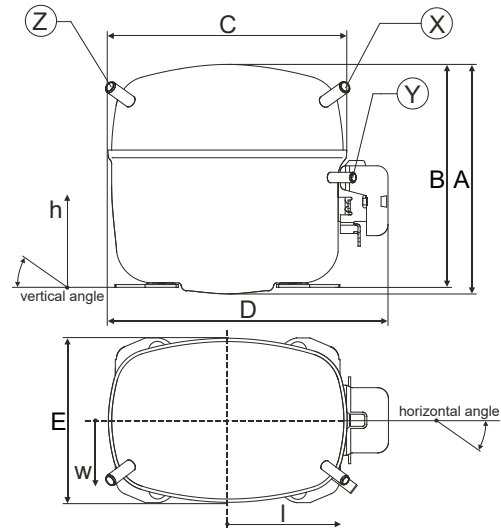

Compressor fixation



Bolt joint

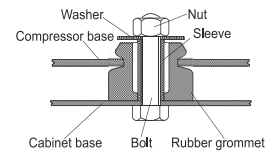

Snap-on

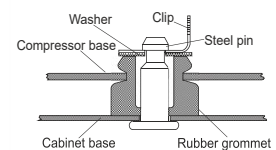

Mounting accessories

Mounting accessories	one comp.	multi pack
Bolt joint M6 ø16mm	118-1917	118-1918
Bolt joint ø1/4" ø16mm	118-1946	
Bolt joint ø1/4" ø19mm	118-1949	
Snap-on ø7,3 ø16mm	118-1947	118-1919

Application notes

Provision for PE Grounding is located at the PE Stamp on the compressor

Model

Designation	SC21CL	220-240V/50Hz	Conf. 1	Sales code:	104L2322
-------------	---------------	----------------------	----------------	-------------	-----------------

Configuration

Motorconfiguration	CSCR
Power supply (nominal)	220-240V/50Hz 1~
Refrigerant	R404A
Application	LBP
Voltage range	198-254V
Starting torque	HST
Approvals	VDE CCC EAC

Electrical accessories / wiring diagram



Ambient/ machine room temperatures minimum /maximum

Ambient temperature range:	10 - 38°C / 50 - 101°F
Machine room temperature range:	10 - 43°C / 50 - 110°F
Compressor cooling:	fan 3m/s

Operation Limits

Operation pressure range

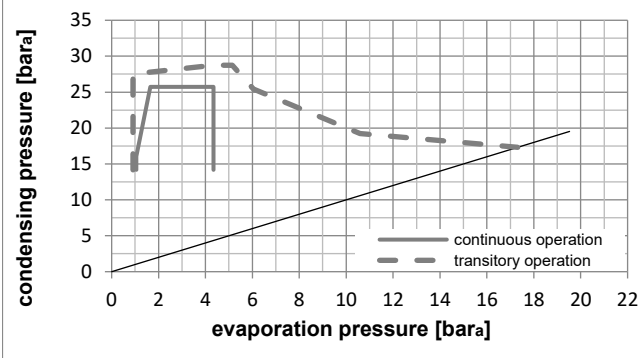
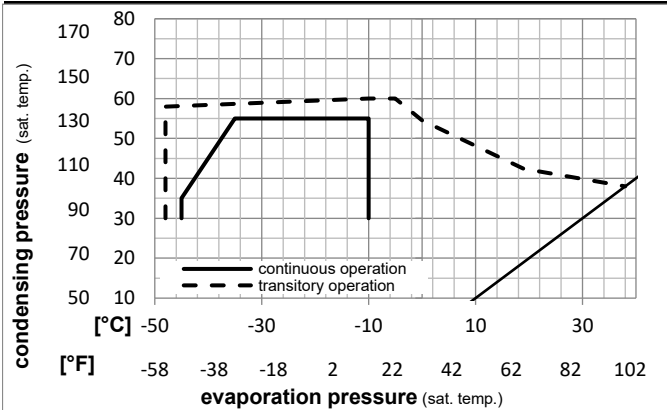

Components

a3	SC starter kit (550mm)	117-7027
b	plastic cover	103N2009
d	cord relief	103N1004

Alternative components

a3	SC starter kit (1000mm)	117-7040
a3	SC starter kit (650mm)	117-7046
c	start capacitor (80µF)	117U5373
e	run capacitor (10µF, 6.3mm)	117-7112

Model

Designation **SC21CL** **220-240V/50Hz** Conf. 1 Sales code: **104L2322**

Optimization + standard conditions

R404A, 220V/50Hz, CSCR, fan 3m/s, VDE, CCC, EAC

		Evaporating pressure (saturation temperature)				Condensing pressure (saturation temperature)			Return gas temp.			Liquid temp.			Cooling capacity			COP	EER	Power consumption			
		pe	pc	RGT	Tliq	[W]	[Btu/h]	[kcal/h]	[W/W]	[Btu/Wh]	[kcal/Wh]	P1	I	Ref. mass flow	[W]	[A]	m	[kg/h]					
[°C]	[°F]																						
-23	54	32	32	902,9	3084	777,1	1,18	4,02	1,01	767,3	4,02	21,04	ASHRAE LBP										
-10	130	90	90																				
-25	55	32	55	608,5	2078	523,6	0,83	2,82	0,71	735,9	3,86	19,02	cecomaf LBP										
-13	131	90	131																				
-35	40	20	40	509,0	1738	438,1	0,98	3,34	0,84	521,1	2,95	13,83	EN12900 LBP										
-31	104	68	104																				
-23	49	4,4	49	685,6	2341	590,0	0,91	3,12	0,79	749,7	3,91	24,27	ARI540 LBP										
-10	120	40	120																				
-23	41	32	32	1091,0	3726	938,9	1,53	5,23	1,32	711,9	3,80	25,42	AHAM LBP										
-10	105	90	90																				
-35	45	32	45	455,0	1554	391,6	0,85	2,91	0,73	534,2	2,94	12,16	opt										
-31	113	90	113																				

Performance tables

R404A, 220V/50Hz, CSCR, fan 3m/s, VDE, CCC, EAC

	pe		Cooling capacity			COP	EER	P1	I	m	
	[°C]	[°F]	[W]	[Btu/h]	[kcal/h]	[W/W]	[Btu/Wh]	[kcal/Wh]	[W]	[A]	[kg/h]
[°C / °F]	-45	-49	225,9	772	194,4	0,57	1,93	0,49	399,6	2,40	6,00
cond. pressure	-35	-31	455,0	1554	391,6	0,85	2,91	0,73	534,2	2,94	12,16
pc= 45/113	-30	-22	617,4	2108	531,3	1,00	3,43	0,86	614,8	3,31	16,57
return gas temp.	-25	-13	812,8	2776	699,5	1,16	3,95	1,00	702,1	3,71	21,92
RGT= 32/90	-20	-4	1042,1	3559	896,9	1,31	4,48	1,13	794,7	4,14	28,27
liquid temp	-15	5	1306,3	4461	1124,2	1,47	5,01	1,26	890,8	4,58	35,68
Tliq= 45/113	-10	14	1606,3	5486	1382,4	1,62	5,55	1,40	989,0	5,00	44,23
[°C / °F]	-45	-49	174,5	596	150,1	0,44	1,49	0,37	401,0	2,29	5,36
cond. pressure	-35	-31	327,7	1119	282,0	0,59	2,02	0,51	553,1	2,94	10,14
pc= 55/131	-30	-22	451,7	1543	388,7	0,70	2,40	0,61	641,4	3,38	14,04
return gas temp	-25	-13	608,5	2078	523,6	0,83	2,82	0,71	735,9	3,86	19,02
RGT= 32/90	-20	-4	798,9	2728	687,5	0,96	3,27	0,82	834,8	4,37	25,14
liquid temp	-15	5	1023,9	3497	881,2	1,09	3,73	0,94	936,7	4,89	32,47
Tliq= 55/131	-10	14	1284,4	4386	1105,4	1,23	4,22	1,06	1040,1	5,41	41,12

Model

Designation	SC21CL	220-240V/50Hz	Conf. 2	Sales code:	104L2322
-------------	---------------	----------------------	----------------	-------------	-----------------

Configuration

Motorconfiguration	CSCR
Power supply (nominal)	220-240V/50Hz 1~
Refrigerant	R452A
Application	LBP
Voltage range	198-254V
Starting torque	HST
Approvals	VDE CCC

Electrical accessories / wiring diagram

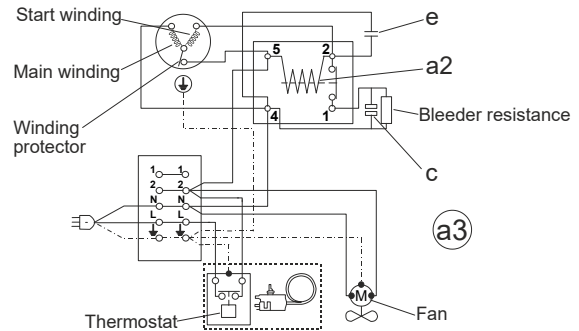

Ambient/ machine room temperatures minimum /maximum

Ambient temperature range:	10 - 38°C / 50 - 101°F
Machine room temperature range:	10 - 43°C / 50 - 110°F
Compressor cooling:	fan 3m/s

Operation Limits

Operation pressure range

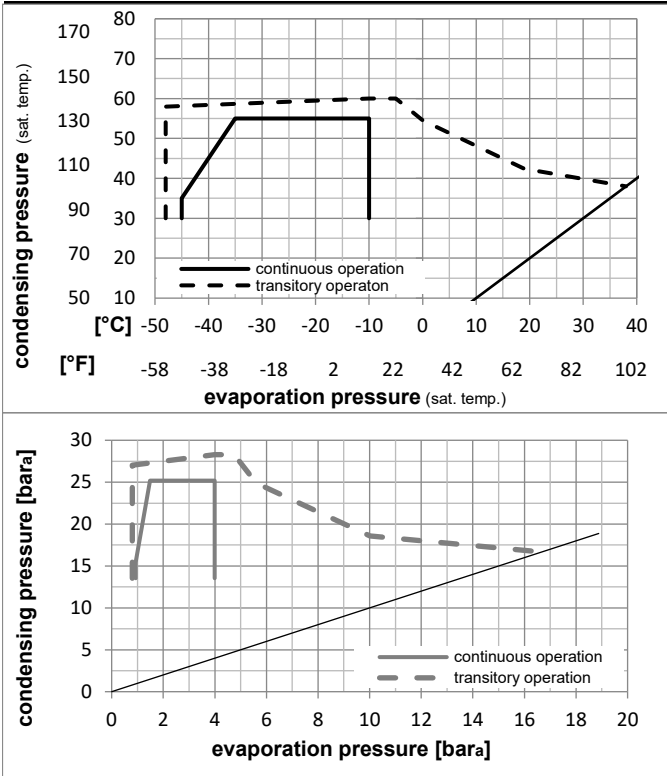

Components

a3	SC starter kit (550mm)	117-7027
b	plastic cover	103N2009
d	cord relief	103N1004

Alternative components

a3	SC starter kit (1000mm)	117-7040
a3	SC starter kit (650mm)	117-7046
c	start capacitor (80µF)	117U5373
e	run capacitor (10µF, 6.3mm)	117-7112

Model

Designation **SC21CL** **220-240V/50Hz** Conf. 2 Sales code: **104L2322**

Optimization + standard conditions

R452A, 220V/50Hz, CSCR, fan 3m/s, VDE, CCC

	Evaporating pressure (saturation temperature)				Cooling capacity						Power consumption			ASHRAE LBP
	pe	pc	RGT	Tliq	[W]	[Btu/h]	[kcal/h]	COP [W/W]	EER [Btu/Wh]	[kcal/Wh]	P1 [W]	I [A]	Ref. mass flow [kg/h]	
[°C]	-23	54	32	32	825,0	2818	710,0	1,16	3,95	1,00	713,2	3,77	19,83	ASHRAE LBP
[°F]	-10	130	90	90										
[°C]	-25	55	32	55	560,3	1914	482,2	0,82	2,81	0,71	681,6	3,63	17,83	cecomaf LBP
[°F]	-13	131	90	131										
[°C]	-35	40	20	40	458,8	1567	394,8	0,96	3,27	0,82	479,3	2,71	12,81	EN12900 LBP
[°F]	-31	104	68	104										
[°C]	-23	49	4,4	49	636,7	2174	548,0	0,91	3,11	0,78	698,7	3,70	22,89	ARI540 LBP
[°F]	-10	120	40	120										
[°C]	-23	41	32	32	1004,3	3430	864,3	1,51	5,15	1,30	665,5	3,55	24,14	AHAM LBP
[°F]	-10	105	90	90										
[°C]	-35	45	32	45	408,5	1395	351,6	0,84	2,85	0,72	489,2	2,76	11,21	opt
[°F]	-31	113	90	113										

Performance tables

R452A, 220V/50Hz, CSCR, fan 3m/s, VDE, CCC

	pe		Cooling capacity			COP	EER	P1	I	m	
	[°C]	[°F]	[W]	[Btu/h]	[kcal/h]	[W/W]	[Btu/Wh]	[kcal/Wh]	[W]	[A]	[kg/h]
[°C / °F]	-45	-49	193,8	662	166,8	0,54	1,86	0,47	356,6	2,16	5,29
cond. pressure	-35	-31	408,5	1395	351,6	0,84	2,85	0,72	489,2	2,76	11,21
pc= 45/113	-30	-22	562,3	1920	483,9	0,99	3,38	0,85	568,2	3,11	15,49
return gas temp.	-25	-13	748,5	2556	644,2	1,14	3,91	0,99	653,9	3,50	20,71
RGT= 32/90	-20	-4	968,5	3308	833,5	1,30	4,44	1,12	744,9	3,91	26,93
liquid temp	-15	5	1223,5	4178	1052,9	1,46	4,98	1,25	839,9	4,34	34,23
Tliq= 45/113	-10	14	1514,6	5173	1303,5	1,62	5,52	1,39	937,4	4,78	42,68
[°C / °F]	-45	-49	148,0	505	127,4	0,43	1,45	0,37	347,9	2,12	4,64
cond. pressure	-35	-31	292,0	997	251,3	0,58	1,99	0,50	500,1	2,81	9,21
pc= 55/131	-30	-22	410,0	1400	352,8	0,70	2,38	0,60	587,8	3,20	12,98
return gas temp	-25	-13	560,3	1914	482,2	0,82	2,81	0,71	681,6	3,63	17,83
RGT= 32/90	-20	-4	744,2	2541	640,4	0,95	3,26	0,82	779,9	4,07	23,82
liquid temp	-15	5	962,8	3288	828,6	1,09	3,73	0,94	881,5	4,52	31,03
Tliq= 55/131	-10	14	1217,3	4157	1047,6	1,24	4,22	1,06	984,9	4,99	39,56



SC Compressors





SC Compressors

Service/Repair – R290



8545



Secop accepts no responsibility for possible errors in catalogs, brochures, and other printed material. Secop reserves the right to alter its products without notice. This also applies to products already on order provided that such alterations can be made without subsequent changes being necessary to specifications already agreed. All trademarks in this material are the property of the respective companies. Secop and the Secop logotype are trademarks of Secop GmbH. All rights reserved. www.secop.com