

8238-58

SCE Compressors

(External Protector)

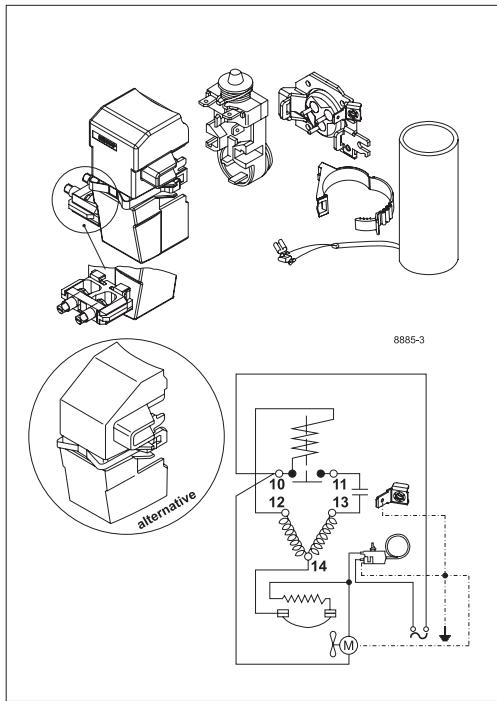
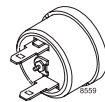

8885-3

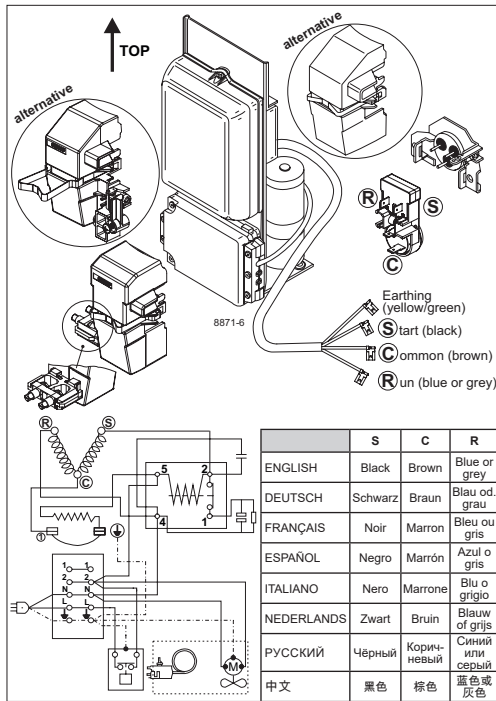

8871-6

Earthing (yellow/green)
Start (black)
Common (brown)
Run (blue or grey)

	S	C	R
ENGLISH	Black	Brown	Blue or grey
DEUTSCH	Schwarz	Braun	Blau od. grau
FRANÇAIS	Noir	Marron	Bleu ou gris
ESPAÑOL	Negro	Marrón	Azul o gris
ITALIANO	Nero	Marrone	Blu o grigio
NEDERLANDS	Zwart	Bruin	Blauw of grijs
РУССКИЙ	Чёрный	Коричневый	Синий или серый
中文	黑色	棕色	蓝色或灰色

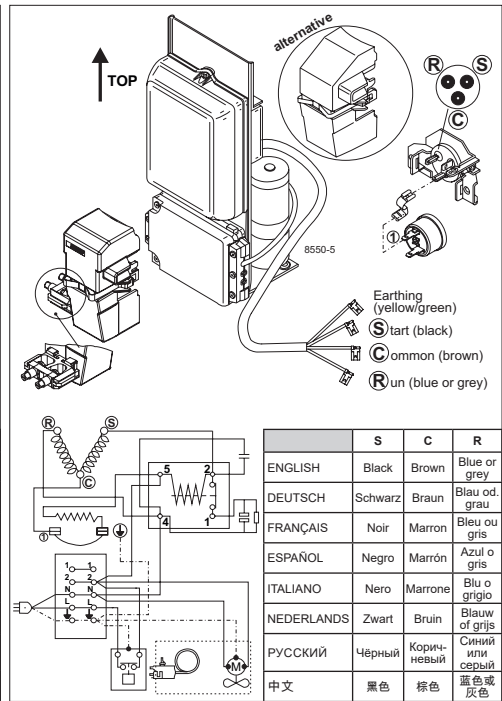

8550-5

Earthing (yellow/green)
Start (black)
Common (brown)
Run (blue or grey)

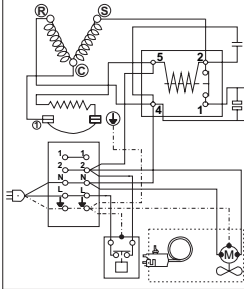

	S	C	R
ENGLISH	Black	Brown	Blue or grey
DEUTSCH	Schwarz	Braun	Blau od. grau
FRANÇAIS	Noir	Marron	Bleu ou gris
ESPAÑOL	Negro	Marrón	Azul o gris
ITALIANO	Nero	Marrone	Blu o grigio
NEDERLANDS	Zwart	Bruin	Blauw of grijs
РУССКИЙ	Чёрный	Коричневый	Синий или серый
中文	黑色	棕色	蓝色或灰色

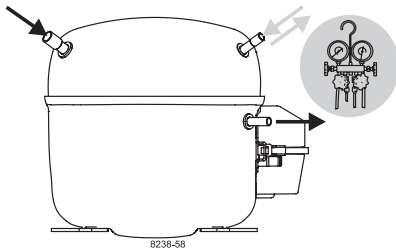

SCE Compressors (External Protector)



Service/Repair – R290

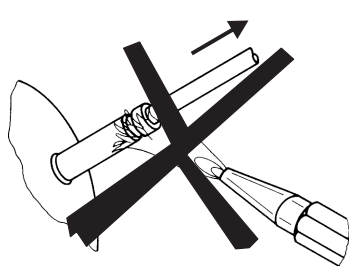

8545

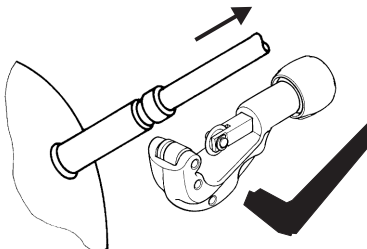

Brazing on Suction Connectors (Direct Intake)

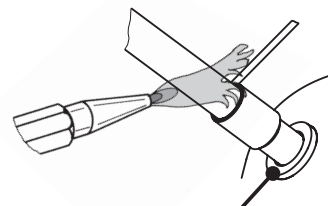

**! max. 350°C/662°F !
at socket**

brazing solder: phosphor (LP7) or silver

8882

Refer to Product Bulletin:
**Brazing on Suction Connectors
(SCE Compressors with Direct Suction Intake)**

Secop accepts no responsibility for possible errors in catalogs, brochures, and other printed material. Secop reserves the right to alter its products without notice. This also applies to products already on order provided that such alterations can be made without subsequential changes being necessary to specifications already agreed. All trademarks in this material are the property of the respective companies. Secop and the Secop logotype are trademarks of Secop GmbH. All rights reserved. www.secop.com