

Single Pack BD35F-HD.2 12/24V DC PM

Single pack code number: **195B4342**

Position	Title	Code	Amount
1	Compressor BD35F-HD.2	101Z0216	1
2	Electronic unit 12/24V DC - Automotive	101N0650	1
3	Snap-on in quantities $\varnothing 7,3$ $\varnothing 16$ mm	118-1919	1

BD35F-HD.2 Heavy Duty Direct Current Compressor R134a, R1234yf, 12/24V DC



General

Code number (without electronic units)	101Z0216
Electronic unit 12/24V DC - Standard	101N0242, 30 pcs: 101N0243
Electronic unit 12/24V DC - Automotive	101N0680, 30 pcs: 101N0681
Compressors on pallet	150

Approvals

R134a	R134a/R1234yf
-	-
-	UL / CB



Application

Application	LBP/MBP/HBP
Evaporating temperature °C	-30 to 0 (10)
Voltage range VDC	9.6 - 17 / 21.3 - 31.5
Max. condensing temperature continuous (short) °C	60 (70)
Max. winding temperature continuous (short) °C	125 (135)

Cooling requirements

Application	LBP	MBP	HBP
32°C	S	S	S
38°C	S	S	S
43°C	S	S	S

Remarks on application: Fan cooling F₁ depending on application and speed.

HD (Heavy Duty) version of the BD35F which can handle extreme vibrations.

New generation with optimized noise level during rough vehicle motions.

Motor

Motor type	variable speed
Resistance, all 3 windings (25°C) Ω	2.2

Design

Displacement cm ³	2.00
Oil quantity (type) cm ³	150 (polyolester)
Maximum refrigerant charge g	300
Free gas volume in compressor cm ³	870
Weight - Compressor/Electronic unit kg	4.3/0.19

Standard battery protection settings (refer to electronic unit Instructions for optional settings)

Voltage	12V	24V
Cut out VDC	10.4	22.8
Cut in VDC	11.7	24.2

Dimensions

Height mm	A	137
	B	135
	B1	128
	B2	73
Suction connector location/I.D. mm angle	C	6.2 40°
	material comment	Cu-plated steel Al cap
Process connector location/I.D. mm angle	D	6.2 45°
	material comment	Cu-plated steel Al cap
Discharge connector location/I.D. mm angle	E	5.0 21°
	material comment	Cu-plated steel Al cap
Connector tolerance I.D. mm		±0.09, on 5.0 +0.12/+0.20
Remarks:		

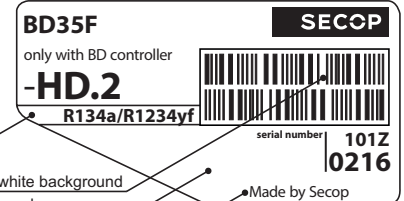

Blue stripe

Barcode on white background

Grey background

Country of origin or manufacturer

serial number
101Z0216

Made by Secop

- S = Static cooling normally sufficient
- O = Oil cooling
- F₁ = Fan cooling 1.5 m/s
(compressor compartment temperature equal to ambient temperature)
- F₂ = Fan cooling 3.0 m/s necessary
- SG = Suction gas cooling normally sufficient
- = not applicable in this area

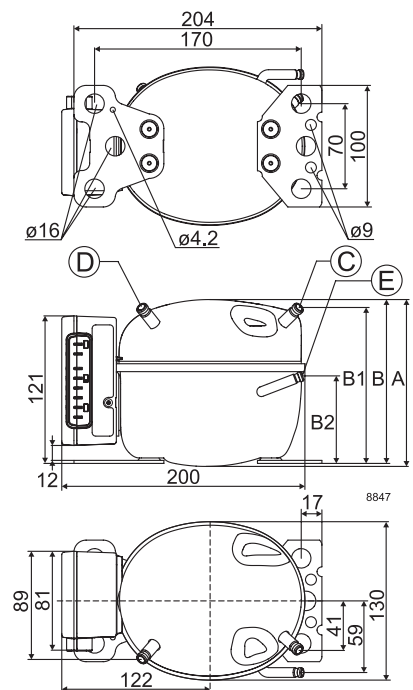

Performance Data with Refrigerant R134a

Capacity (EN 12900 Household/CECOMAF) 12V DC, static cooling watt												
rpm \ °C	-30	-25	-23.3	-20	-15	-10	-5	0	5	7.2	10	15
2,000	16.0	23.8	26.7	32.9	43.7	56.5	71.8	89.8	111	121	136	
2,500	18.8	29.9	33.9	41.9	55.4	71.1	89.8	112	139	152		
3,000	22.4	32.9	37.1	46.1	62.5	82.2	106	133				
3,500	27.0	35.9	40.2	50.3	69.8	93.9	122					

Capacity (ASHRAE LBP) 12V DC, static cooling watt												
rpm \ °C	-30	-25	-23.3	-20	-15	-10	-5	0	5	7.2	10	15
2,000	20.0	29.8	33.4	41.2	54.6	70.6	89.7	112	139	152	169	
2,500	23.6	37.5	42.4	52.4	69.2	88.8	112	140	173	190		
3,000	28.1	41.3	46.5	57.9	78.2	103	132	166				
3,500	33.9	45.1	50.5	63.1	87.3	117	153					

Power consumption 12V DC, static cooling watt												
rpm \ °C	-30	-25	-23.3	-20	-15	-10	-5	0	5	7.2	10	15
2,000	17.7	22.9	24.6	27.7	32.2	36.7	41.3	46.2	51.6	54.3	57.8	
2,500	22.1	29.7	32.0	36.3	42.4	48.1	53.8	59.7	66.1	69.1		
3,000	29.3	34.6	36.7	41.2	48.7	56.5	64.5	72.0				
3,500	34.5	41.3	43.8	48.9	57.3	66.2	75.4					

Current consumption (for 24V applications the following must be halved) A												
rpm \ °C	-30	-25	-23.3	-20	-15	-10	-5	0	5	7.2	10	15
2,000	1.4	1.9	2.0	2.3	2.7	3.1	3.4	3.8	4.3	4.5	4.8	
2,500	1.8	2.5	2.7	3.0	3.5	4.0	4.5	5.0	5.5	5.8		
3,000	2.4	2.9	3.1	3.4	4.0	4.7	5.3	6.0				
3,500	2.9	3.4	3.6	4.1	4.8	5.5	6.3					

COP (EN 12900 Household/CECOMAF) 12V DC, static cooling W/W												
rpm \ °C	-30	-25	-23.3	-20	-15	-10	-5	0	5	7.2	10	15
2,000	0.90	1.04	1.09	1.19	1.36	1.54	1.74	1.94	2.15	2.24	2.35	
2,500	0.85	1.01	1.06	1.15	1.31	1.48	1.67	1.88	2.10	2.20		
3,000	0.76	0.95	1.01	1.12	1.28	1.45	1.64	1.85				
3,500	0.78	0.87	0.92	1.03	1.22	1.42	1.62					

COP (ASHRAE LBP) 12V DC, static cooling W/W												
rpm \ °C	-30	-25	-23.3	-20	-15	-10	-5	0	5	7.2	10	15
2,000	1.13	1.30	1.36	1.49	1.70	1.93	2.18	2.44	2.70	2.81	2.95	
2,500	1.07	1.26	1.33	1.45	1.64	1.86	2.10	2.36	2.64	2.77		
3,000	0.96	1.19	1.27	1.41	1.61	1.83	2.06	2.32				
3,500	0.98	1.09	1.15	1.29	1.53	1.78	2.03					

Test conditions with electronic unit		EN 12900/CECOMAF	ASHRAE LBP
Condensing temperature	101N0242 101N0680	55°C	54.4°C
Ambient temperature		32°C	32°C
Suction gas temperature		32°C	32°C
Liquid temperature		no subcooling	32°C

Accessories for BD35F-HD.2		Code number
Bolt joint for one comp.	Ø:16 mm	118-1917
Bolt joint in quantities	Ø:16 mm	118-1918
Snap-on in quantities	Ø:16 mm	118-1919
Remote kit (without cable)		105N9210
Secop Gateway		105N9518
Automobile fuse, DIN 7258	12V: 15A 24V: 7.5 A	Not deliverable
Main switch	min. 20A	from Secop

Compressor speed		
Electronit unit	Resistor (R1) [Ω]	Motor speed
Code number	calculated values	[rpm]
101N0242 101N0680	0	2,000
	277	2,500
	692	3,000
	1523	3,500

Wire dimensions					
Size		Max. length* 12V operation		Max. length* 24V operation	
Cross section	AWG	[m]	[ft.]	[m]	[ft.]
2.5	12	2.5	8	5	16
4	12	4	13	8	26
6	10	6	20	12	39
10	8	10	33	20	66

*Length between battery and electronic unit

Operational errors	
Error code or LED flashes	Error type
	Can be read out in the software TOOL4COOL®
6	Thermostat failure (If the NTC thermistor is short-circuit or has no connection).
5	Thermal cut-out of electronic unit (If the refrigeration system has been too heavily loaded, or if the ambient temperature is high, the electronic unit will run too hot).
4	Minimum motor speed error (If the refrigeration system is too heavily loaded, the motor cannot maintain minimum speed at approximately 1,850 rpm).
3	Motor start error (The rotor is blocked or the differential pressure in the refrigeration system is too high (>5 bar)).
2	Too many start attempts or fan over current (Too many compressor or fan starts in short time or fan current higher than 0.5A _{avg}).
1	Battery protection cut-out (The voltage is outside the cut-out setting).

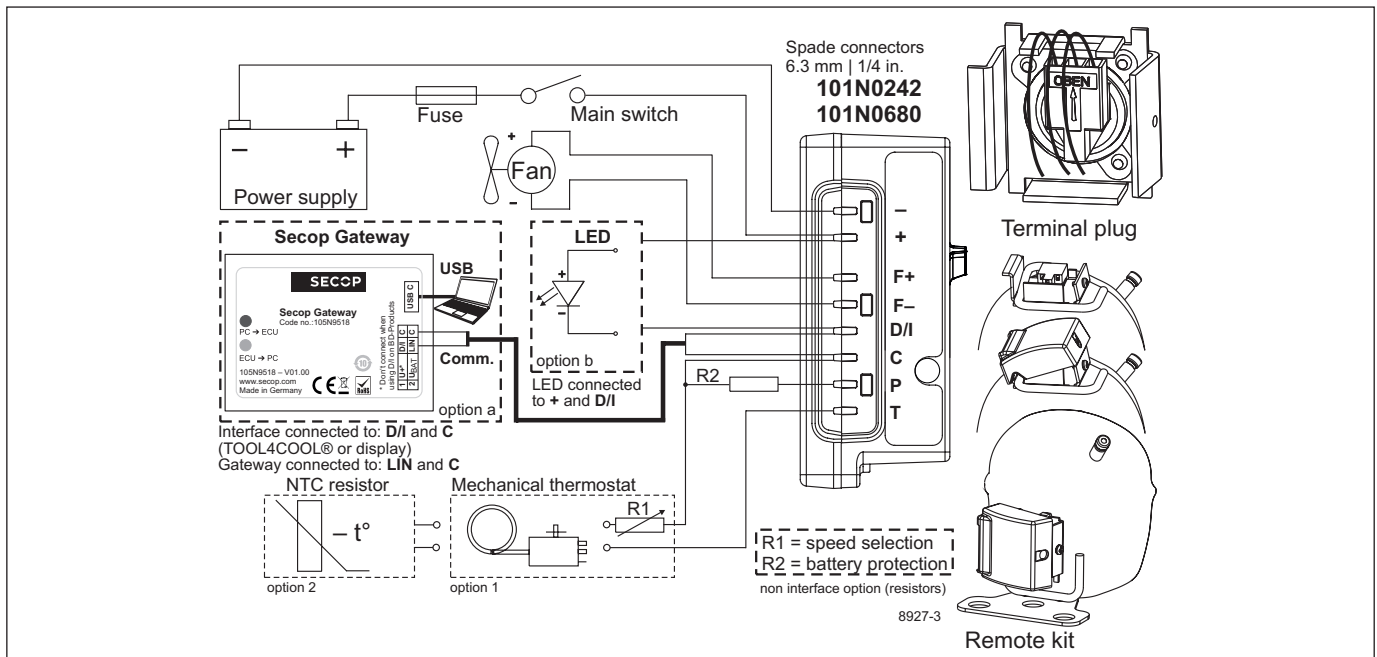

Performance Data with Refrigerant R1234yf

Capacity (EN 12900 Household/CECOMAF) 12V DC, static cooling watt												
rpm \ °C	-30	-25	-23.3	-20	-15	-10	-5	0	5	7.2	10	15
2,000	17.0	24.8	27.8	34.2	45.1	57.7	72.0	87.9	106	114	125	
2,500	18.5	29.6	33.8	42.6	57.3	73.8	92.0	111.8	133	143		
3,000	25.5	35.4	39.2	47.6	62.6	80.6	102	127				
3,500	30.3	39.3	43.4	52.6	69.9	91.1	116					

Capacity (ASHRAE LBP) 12V DC, static cooling watt												
rpm \ °C	-30	-25	-23.3	-20	-15	-10	-5	0	5	7.2	10	15
2,000	22.1	32.3	36.2	44.5	58.7	75.1	93.6	114	137	148	163	
2,500	24.1	38.5	44.0	55.3	74.4	95.7	119	145	173	186		
3,000	33.5	46.3	51.4	62.3	81.8	105	133	165				
3,500	39.4	51.3	56.6	68.7	91.3	119	152					

Power consumption 12V DC, static cooling watt												
rpm \ °C	-30	-25	-23.3	-20	-15	-10	-5	0	5	7.2	10	15
2,000	19.2	24.1	25.7	28.8	33.3	37.8	42.3	46.8	51.4	53.4	56.1	
2,500	24.0	31.4	33.7	38.1	44.4	50.3	55.8	61.0	66.0	68.2		
3,000	32.6	37.0	38.9	42.9	49.7	57.1	64.5	71.5				
3,500	38.7	44.8	47.1	51.8	59.5	67.5	75.8					

Current consumption (for 24V applications the following must be halved) A												
rpm \ °C	-30	-25	-23.3	-20	-15	-10	-5	0	5	7.2	10	15
2,000	1.6	2.0	2.1	2.4	2.8	3.1	3.5	3.9	4.3	4.5	4.7	
2,500	2.0	2.6	2.8	3.2	3.7	4.2	4.6	5.1	5.5	5.7		
3,000	2.7	3.1	3.2	3.6	4.1	4.8	5.4	6.0				
3,500	3.2	3.7	3.9	4.3	5.0	5.6	6.3					

COP (EN 12900 Household/CECOMAF) 12V DC, static cooling W/W												
rpm \ °C	-30	-25	-23.3	-20	-15	-10	-5	0	5	7.2	10	15
2,000	0.88	1.03	1.08	1.19	1.35	1.52	1.69	1.87	2.04	2.11	2.21	
2,500	0.77	0.94	1.00	1.11	1.28	1.46	1.64	1.82	2.00	2.08		
3,000	0.78	0.95	1.01	1.11	1.25	1.41	1.57	1.77				
3,500	0.78	0.88	0.92	1.01	1.17	1.34	1.52					

COP (ASHRAE LBP) 12V DC, static cooling W/W												
rpm \ °C	-30	-25	-23.3	-20	-15	-10	-5	0	5	7.2	10	15
2,000	1.15	1.34	1.41	1.55	1.76	1.99	2.21	2.45	2.68	2.78	2.90	
2,500	1.00	1.23	1.30	1.45	1.67	1.90	2.14	2.38	2.62	2.73		
3,000	1.03	1.25	1.32	1.45	1.65	1.84	2.06	2.31				
3,500	1.02	1.15	1.20	1.33	1.54	1.76	2.00					

Test conditions with electronic units		EN 12900/CECOMAF	ASHRAE LBP
Condensing temperature	101N0242 101N0680	55°C	54.4°C
Ambient temperature		32°C	32°C
Suction gas temperature		32°C	32°C
Liquid temperature		no subcooling	32°C

Accessories for BD35F-HD.2		Code number
Bolt joint for one comp.	Ø:16 mm	118-1917
Bolt joint in quantities	Ø:16 mm	118-1918
Snap-on in quantities	Ø:16 mm	118-1919
Remote kit (without cable)		105N9210
Secop Gateway		105N9518
Automobile fuse, DIN 7258	12V: 15A 24V: 7.5 A	Not deliverable
Main switch	min. 20A	from Secop

Compressor speed		
Electronit unit	Resistor (R1) [Ω]	Motor speed
Code number	calculated values	[rpm]
	0	2,000
101N0242	277	2,500
101N0680	692	3,000
	1523	3,500

Wire dimensions					
Size		Max. length* 12V operation		Max. length* 24V operation	
Cross section	AWG				
[mm²]	[Gauge]	[m]	[ft.]	[m]	[ft.]
2.5	12	2.5	8	5	16
4	12	4	13	8	26
6	10	6	20	12	39
10	8	10	33	20	66

*Length between battery and electronic unit

Operational errors	
Error code or LED flashes	Error type
	Can be read out in the software TOOL4COOL®
6	Thermostat failure (If the NTC thermistor is short-circuit or has no connection).
5	Thermal cut-out of electronic unit (If the refrigeration system has been too heavily loaded, or if the ambient temperature is high, the electronic unit will run too hot).
4	Minimum motor speed error (If the refrigeration system is too heavily loaded, the motor cannot maintain minimum speed at approximately 1,850 rpm).
3	Motor start error (The rotor is blocked or the differential pressure in the refrigeration system is too high (>5 bar)).
2	Too many start attempts or fan over current (Too many compressor or fan starts in short time or fan current higher than 0.5A _{avg}).
1	Battery protection cut-out (The voltage is outside the cut-out setting).

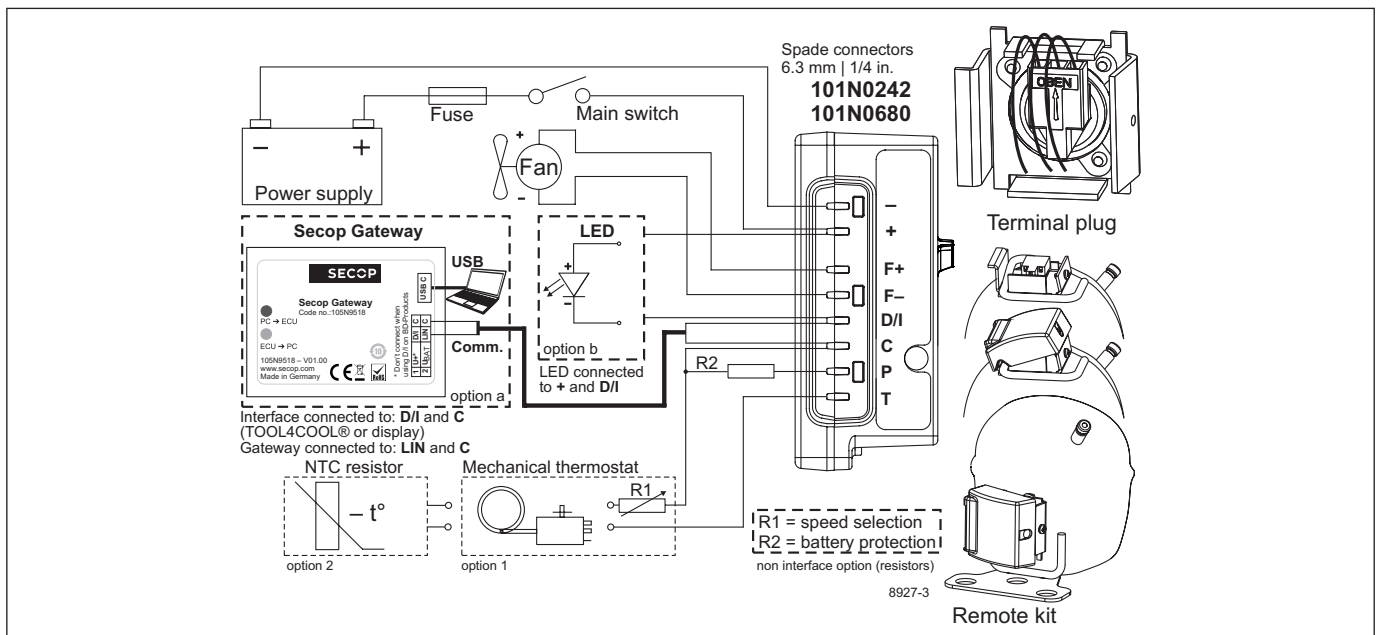

Secop accepts no responsibility for possible errors in catalogs, brochures, and other printed material. Secop reserves the right to alter its products without notice. This also applies to products already on order provided that such alterations can be made without subsequent changes being necessary to specifications already agreed. All trademarks in this material are the property of the respective companies. Secop and the Secop logotype are trademarks of Secop GmbH. All rights reserved. www.secop.com



Instructions for Electronic Units
are available for download on
www.secop.com



BD Compressors



Service/Repair

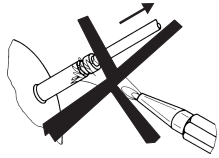

8545

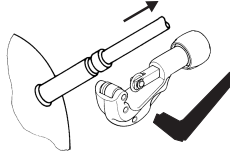

R290



R600a



R170



R1234yf

BD Nano

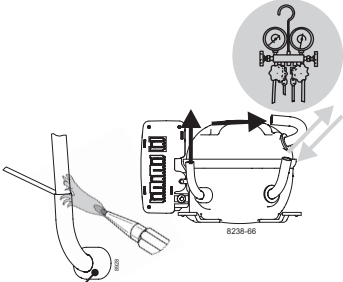

8238-66

**! max. 150°C/302°F !
at socket**

brazing solder: silver with flux

Do not heat up the bottom of the discharge connector directly.
Do not braze longer than 10 seconds and wait for 5 minutes for the next soldering attempt (Product Bulletin DES.N.101.M1).

BD Micro

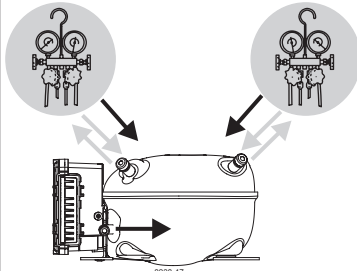

8238-47

BD P-Housing

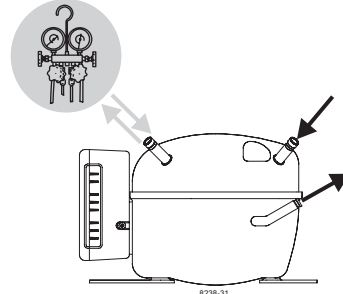

8238-31

BD T-Housing

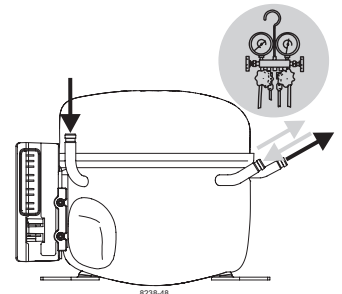

8238-48

Secop accepts no responsibility for possible errors in catalogs, brochures, and other printed material. Secop reserves the right to alter its products without notice. This also applies to products already on order provided that such alterations can be made without subsequent changes being necessary to specifications already agreed. All trademarks in this material are the property of the respective companies. Secop and the Secop logotype are trademarks of Secop GmbH. All rights reserved. www.secop.com