

Single Pack SCE18CNLX 220-240V 50Hz CSIR

Codice Imballo Singolo: **195B4379**

Posizione	Titolo	Codice	Quantità
1	Compressor SCE18CNLX	104H8848	1
2	Starting capacitor (80 μ F 220V, 6.3mm)	117U5017	1
3	Cord relief	103N1004	1
4	Bolt joint for one compressor M6 \varnothing 16mm	118-1917	1

Secop GmbH • Lise-Meitner-Straße 29 • 24941 Flensburg, Germany • Tel: +49 46149410 • www.secop.com

Secop non si assume alcuna responsabilità per eventuali errori presenti in cataloghi, brochure e altro materiale stampato. Secop si riserva il diritto di modificare i propri prodotti senza preavviso. Ciò vale anche per i prodotti già ordinati, a condizione che tali modifiche possano essere apportate senza che siano necessarie modifiche successive alle specifiche già concordate. Tutti i marchi presenti in questo materiale sono di proprietà delle rispettive aziende. Secop e il logo Secop sono marchi di Secop GmbH. Tutti i diritti sono riservati.

Model

Designation	SCE18CNLX	220-240V/50Hz 1~	Sales code:	104H8848
-------------	------------------	------------------	-------------	-----------------

Compressor design

Oil type	Polyolester	Refrigerant(s)	R290
Oil viscosity	32cSt	Displacement	17,69cm ³ / 1,08cu.in
Oil quantity	550cm ³ / 18,6fl.oz	Compressors on pallet	80
Refr. charge - tech. limit	550g / 19,4oz		
Free gas volume comp.	1460cm ³ / 49,4fl.oz		
Weight	14,2kg / 31,3lbs		
Motor protection	external		
Winding resistance main	4,07Ω (at 25°C)		
Winding resistance aux	15,88Ω (at 25°C)		
Max. winding temp.	125°C / 257°F		
Max. discharge temp.	140°C / 284°F		



General - Configurations with SCE18CNLX

	Conf. 1
Motorconfiguration	CSIR
Power supply (nominal)	220-240V/50Hz
Number of phases	1
Voltage range	198-254V
Approvals	VDE
Starting torque	HST
Note	Protector, relay and cover are included and pre-assembled to compressor.

Applications with SCE18CNLX

	Conf. 1
Refrigerant	R290
Application	LBP
System cooling	fan 3m/s
Hot gas defrost	OK
Long interval pull down	-/-

Electrical data - Configurations with SCE18CNLX

	Conf. 1
Starting device type	relay
Run capacitor	-/-
Start capacitor	80μF
LRA (locked rotor amps / 4s/ U(N))	17,47A
RLA (rated load amps / 1s/ U(N))	2,92A
Cut in current (U(N))	17,47A

Model

Designation

SCE18CNLX

220-240V/50Hz 1~

Sales code:

104H8848

Compressor dimensions

Housing	A Height	219mm / 8,62in
	B Height	213mm / 8,39in
	C Length shell	218mm / 8,58in
	D Length w. cover	255mm / 10,04in
	E Width	151mm / 5,94in

Connectors		Suction	Discharge	Process
		X	Y	Z
Diameter	[mm]	øi 10,11-10,29	øi 6,11-6,29	øi 6,11-6,29
(i:inside, o:outside)	[in]	øi 0,4-0,41	øi 0,24-0,25	øi 0,24-0,25
Material		copper	copper	copper
Horizontal angle	±2°	37°	37°	143°
Vertical angle	±2°	30°	0°	150°
Position l/h/w	[mm]	107/193/55	115/110/63	-107/193/55
	[in]	4,2/7,6/2,2	4,5/4,3/2,5	-4,2/7,6/2,2
Straight tube l.	[mm]	12	12	12
	[in]	0,5	0,5	0,5



Compressor fixation

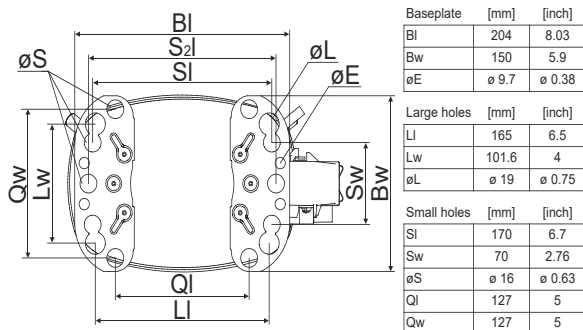

Bolt joint



Snap-on

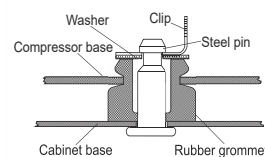

Mounting accessories

Mounting accessories	one comp.	multi pack
Bolt joint M6 ø16mm	118-1917	118-1918
Bolt joint ø1/4" ø16mm	118-1946	
Bolt joint ø1/4" ø19mm	118-1949	
Snap-on ø7,3 ø16mm	118-1947	118-1919

Application notes

Provision for PE Grounding is located at the PE Stamp on the compressor

Model

Designation	SCE18CNLX	220-240V/50Hz	Conf. 1	Sales code:	104H8848
-------------	------------------	----------------------	----------------	-------------	-----------------

Configuration

Motor configuration	CSIR
Power supply (nominal)	220-240V/50Hz 1~
Refrigerant	R290
Application	LBP
Voltage range	198-254V
Starting torque	HST
Approvals	VDE

Electrical accessories / wiring diagram

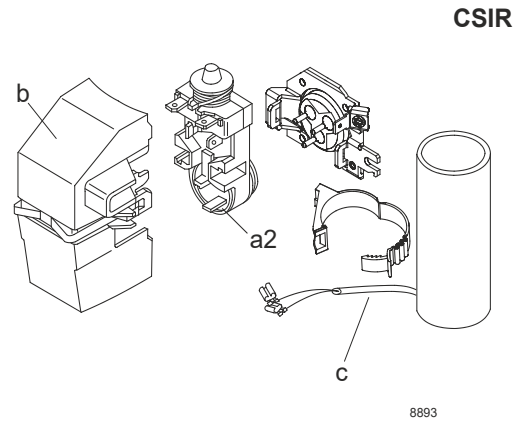

Ambient/ machine room temperatures minimum /maximum

Ambient temperature range:	10 - 43°C / 50 - 110°F
Machine room temperature range:	10 - 48°C / 50 - 119°F
Compressor cooling:	fan 3m/s

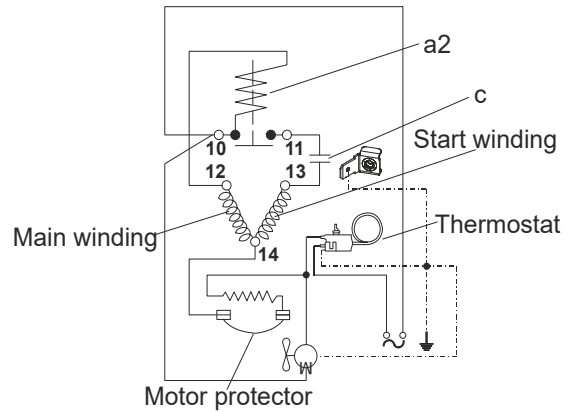

Operation pressure range

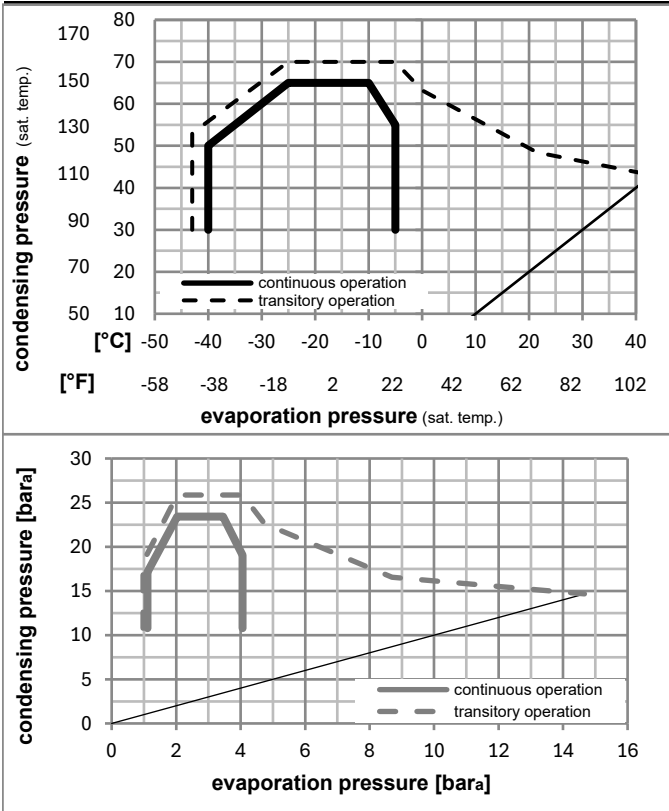

Components (relay (a2)+ cover (b): pre-assembled)

a2	assy. relay + ext. protector (T1133)	117U7405
c	start capacitor (80µF)	117U5017
d	cord relief	103N1004
b	plastic cover + clamp	117U1033

Model

Designation **SCE18CNLX 220-240V/50Hz** Conf. 1 Sales code: **104H8848**

Optimization + standard conditions

R290, 230V/50Hz, CSIR, fan 3m/s, VDE

	pe	pc	RGT	Tliq	Cooling capacity	COP	EER	P1	I	Ref. mass flow	
	[°C]	[°C]	[°C]	[°C]	[W]	[W/W]	[Btu/Wh]	[W]	[A]	[kg/h]	
	[°F]	[°F]	[°F]	[°F]	[Btu/h]	[kcal/h]	[kcal/Wh]	[W]	[A]	[kg/h]	
ASHRAE LBP	-23	54	32	32	791,4	1,51	5,16	524,2	3,00	8,01	
	-10	130	90	90							
cecomaf LBP	-25	55	32	55	586,1	1,17	3,99	502,3	2,94	7,30	
	-13	131	90	131							
EN12900 LBP	-35	40	20	40	439,6	1,22	4,15	361,4	2,58	5,02	
	-31	104	68	104							
ARI540 LBP	-23	49	4,4	49	650,4	1,27	4,34	511,3	2,96	9,01	
	-10	120	40	120							
AHAM LBP	-23	41	32	32	868,7	1,77	6,05	490,5	2,93	8,80	
	-10	105	90	90							
opt	-35	45	32	45	413,7	1,14	3,89	362,7	2,56	4,64	
	-31	113	90	113							

Performance tables

R290, 230V/50Hz, CSIR, fan 3m/s, VDE

	pe	Cooling capacity	COP	EER	P1	I	m
	[°C]	[W]	[W/W]	[Btu/Wh]	[W]	[A]	[kg/h]
	[°F]	[Btu/h]	[kcal/h]	[kcal/Wh]	[W]	[A]	[kg/h]
cond. pressure	-40	314,6	1,04	3,57	301,3	2,42	3,52
	-35	413,7	1,14	3,89	362,7	2,56	4,64
pc= 45/113	-30	542,1	1,28	4,37	423,7	2,72	6,09
return gas temp.	-25	701,1	1,45	4,96	483,0	2,89	7,91
RGT= 32/90	-20	891,6	1,65	5,65	539,3	3,07	10,10
liquid temp	-15	1114,8	1,89	6,44	591,1	3,25	12,68
Tliq= 45/113	-5	1663,3	2,46	8,40	676,3	3,57	19,15
cond. pressure	-40	230,5	0,80	2,72	289,5	2,34	2,84
	-35	324,7	0,90	3,08	360,0	2,51	4,01
pc= 55/131	-30	442,8	1,03	3,51	431,4	2,71	5,49
return gas temp.	-25	586,1	1,17	3,99	502,3	2,94	7,30
RGT= 32/90	-20	755,4	1,32	4,52	571,4	3,17	9,45
liquid temp	-15	952,0	1,49	5,10	637,4	3,41	11,97
Tliq= 55/131	-5	1431,1	1,90	6,48	754,8	3,86	18,23

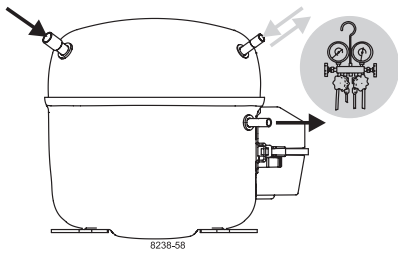

SCE Compressors

(External Protector)

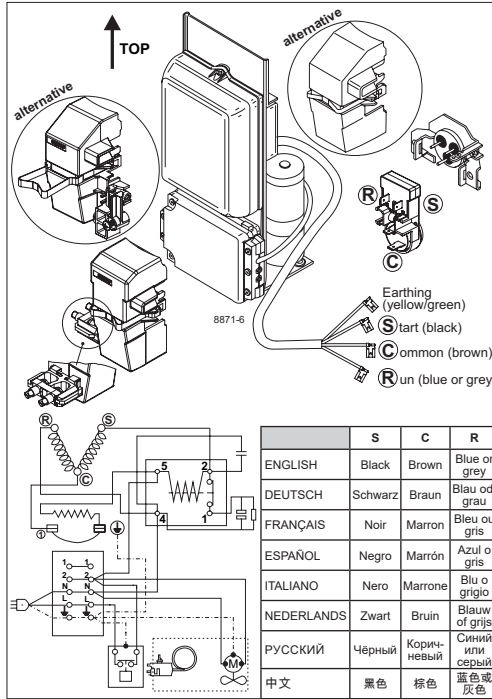

	S	C	R
ENGLISH	Black	Brown	Blue or grey
DEUTSCH	Schwarz	Braun	Blau od. grau
FRANÇAIS	Noir	Marron	Bleu ou gris
ESPAÑOL	Negro	Marrón	Azul o gris
ITALIANO	Nero	Marrone	Blu o grigio
NEDERLANDS	Zwart	Bruin	Blauw of grijs
РУССКИЙ	Чёрный	Коричневый	Синий или серый
中文	黑色	棕色	蓝色或灰色

	S	C	R
ENGLISH	Black	Brown	Blue or grey
DEUTSCH	Schwarz	Braun	Blau od. grau
FRANÇAIS	Noir	Marron	Bleu ou gris
ESPAÑOL	Negro	Marrón	Azul o gris
ITALIANO	Nero	Marrone	Blu o grigio
NEDERLANDS	Zwart	Bruin	Blauw of grijs
РУССКИЙ	Чёрный	Коричневый	Синий или серый
中文	黑色	棕色	蓝色或灰色



SCE Compressors (External Protector)



Service/Repair – R290

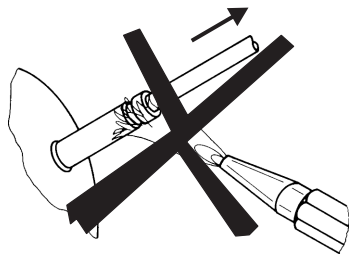

8545

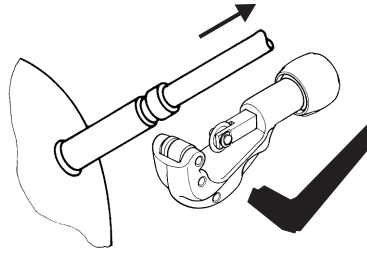

Brazing on Suction Connectors (Direct Intake)

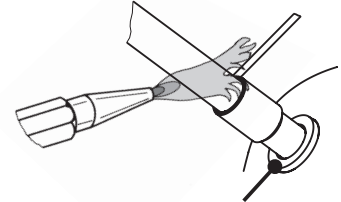

! max. 350°C/662°F !
at socket
 brazing solder: phosphor (LP7) or silver

8882

Refer to Product Bulletin:
Brazing on Suction Connectors
(SCE Compressors with Direct Suction Intake)

Secop accepts no responsibility for possible errors in catalogs, brochures, and other printed material. Secop reserves the right to alter its products without notice. This also applies to products already on order provided that such alterations can be made without subsequential changes being necessary to specifications already agreed. All trademarks in this material are the property of the respective companies. Secop and the Secop logotype are trademarks of Secop GmbH. All rights reserved. www.secop.com