

Single Pack BD35F 12/24V DC PM

Codice Imballo Singolo: **195B4549**

Posizione	Titolo	Codice	Quantità
1	Compressor BD35F	101Z0204	1
2	Electronic unit 12/24V DC - Standard	101N0213	1
3	Bolt joint for one compressor M6 ø16mm	118-1917	1

Secop GmbH · Lise-Meitner-Straße 29 · 24941 Flensburg, Germany · Tel: +49 46149410 · www.secop.com

Secop non si assume alcuna responsabilità per eventuali errori presenti in cataloghi, brochure e altro materiale stampato. Secop si riserva il diritto di modificare i propri prodotti senza preavviso. Ciò vale anche per i prodotti già ordinati, a condizione che tali modifiche possano essere apportate senza che siano necessarie modifiche successive alle specifiche già concordate. Tutti i marchi presenti in questo materiale sono di proprietà delle rispettive aziende. Secop e il logo Secop sono marchi di Secop GmbH. Tutti i diritti sono riservati.

BD35F Direct Current Compressor R134a, R1234yf, 12/24V DC, 10-45V DC Solar & 100-240V AC 50/60Hz



General

Code number (without electronic units)	101Z0204
Electronic unit 12/24V DC - Standard	101N0242, 30 pcs: 101N0243
Electronic unit 12/24V DC - AEO	101N0340, 30 pcs: 101N0341
Electronic unit 10-45V DC - Solar	101N0420, 30 pcs: 101N0421
Electronic unit 12/24V DC & 100-240V AC 50/60Hz	101N0510, 28 pcs: 101N0511
Electronic unit 12/24V DC - Automotive	101N0680, 30 pcs: 101N0681
Compressors on pallet	150

Approvals

Approvals	Approvals
R134a	R134a/R1234yf
–	–
VDE	UL
VDE	–
VDE	UL
–	UL / CB



Application

Application	LBP/MBP/HBP
Evaporating temperature	°F -20 to 50
Voltage range DC	VDC 9.6 - 17 / 21.3 - 31.5
Voltage range AC	V/Hz 100 - 240 / 50 - 60
Voltage range for solar applications	VDC 10 - 45
Max. condensing temperature continuous (short)	°F 140 (158)
Max. winding temperature continuous (short)	°F 257 (275)

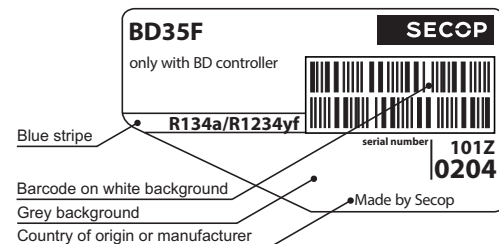

Cooling requirements

Application	LBP	MBP	HBP
32°C	S	S	S
38°C	S	S	S
43°C	S	S	S

Remarks on application: Fan cooling F₁ depending on application and speed.

- S = Static cooling normally sufficient
- O = Oil cooling
- F₁ = Fan cooling 1.5 m/s (compressor compartment temperature equal to ambient temperature)
- F₂ = Fan cooling 3.0 m/s necessary
- SG = Suction gas cooling normally sufficient
- = not applicable in this area

Motor

Motor type	variable speed
Resistance, all 3 windings (25°C)	Ω 2.2

Design

Displacement	cu.in.	0.12
Oil quantity (type)	fl.oz.	5.1 (polyolester)
Maximum refrigerant charge	oz.	10.5
Free gas volume in compressor	fl.oz.	29.6
Weight - Compressor/Electronic unit	lbs.	9.5 / 0.42 (Standard)

Standard battery protection settings (refer to electronic unit Instructions for optional settings)

Voltage	12V	24V
Cut out	VDC 10.4	22.8
Cut in	VDC 11.7	24.2

Dimensions

Height	inch	A	5.39
		B	5.32
		B1	5.04
		B2	2.87
Suction connector	location/I.D. inch angle	C	0.252-0259 40°
	material comment		Cu-plated steel Al cap
Process connector	location/I.D. inch angle	D	0.252-0259 45°
	material comment		Cu-plated steel Al cap
Discharge connector	location/I.D. inch angle	E	0.202-0.205 21°
	material comment		Cu-plated steel Al cap

Remarks: **inch connectors**

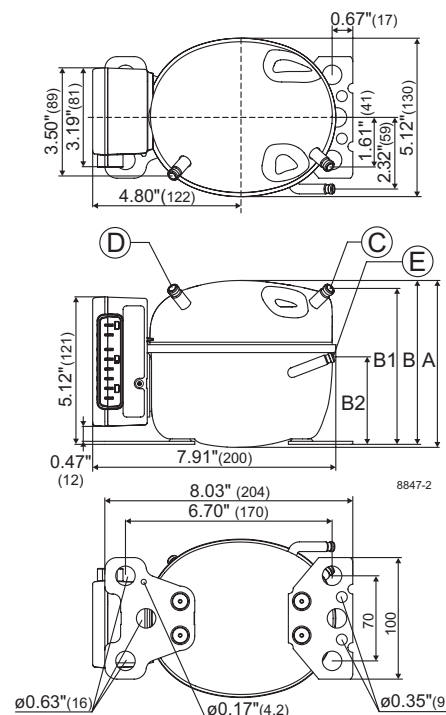

Performance Data with Refrigerant R134a

Capacity (ASHRAE LBP)		12V DC, static cooling										BTU/h
rpm \ °F	-20	-13	-10	0	10	14	20	30	40	41	45	50
2,000	75.2	101	114	160	215	241	283	364	462	472	517	577
2,500	90.9	128	144	203	272	303	354	455	577	591	649	
3,000	105	141	158	226	311	350	415	539				
3,500	122	154	172	249	352	400	479	626				

Capacity (EN 12900 Household/CECOMAF)		12V DC, static cooling										watt
rpm \ °F	-20	-13	-10	0	10	14	20	30	40	41	45	50
2,000	17.7	23.8	26.7	37.4	50.5	56.5	66.4	85.5	108	111	121	136
2,500	21.3	29.9	33.8	47.6	63.8	71.1	83.2	107	136	139	152	
3,000	24.5	32.9	37.0	53.0	73.0	82.2	97.4	127				
3,500	28.5	35.9	40.1	58.4	82.6	93.9	112	147				

Power consumption		12V DC, static cooling										watt
rpm \ °F	-20	-13	-10	0	10	14	20	30	40	41	45	50
2,000	19.0	22.9	24.5	29.6	34.6	36.5	39.5	44.8	50.7	51.4	54.0	57.5
2,500	23.9	29.7	31.9	39.0	45.4	47.9	51.6	58.0	65.0	65.7	68.8	
3,000	30.4	34.6	36.6	44.3	52.8	56.3	61.5	70.0				
3,500	36.0	41.3	43.7	52.5	62.0	65.9	72.0	82.2				

Current consumption (for 24V applications the following must be halved)												A
rpm \ °F	-20	-13	-10	0	10	14	20	30	40	41	45	50
2,000	1.51	1.87	2.02	2.47	2.89	3.05	3.30	3.73	4.20	4.25	4.46	4.74
2,500	1.99	2.47	2.66	3.25	3.79	4.00	4.31	4.84	5.42	5.48	5.74	
3,000	2.49	2.88	3.05	3.70	4.39	4.67	5.10	5.81				
3,500	2.99	3.42	3.63	4.36	5.15	5.48	5.99	6.85				

EER (ASHRAE LBP)		12V DC, static cooling										BTU/Wh
rpm \ °F	-20	-13	-10	0	10	14	20	30	40	41	45	50
2,000	3.97	4.42	4.63	5.38	6.23	6.59	7.15	8.12	9.10	9.20	9.58	10.05
2,500	3.80	4.31	4.51	5.21	5.98	6.32	6.86	7.84	8.89	9.00	9.43	
3,000	3.45	4.06	4.31	5.11	5.89	6.22	6.74	7.70				
3,500	3.39	3.73	3.93	4.75	5.68	6.07	6.65	7.62				

COP (EN 12900 Household/CECOMAF)		12V DC, static cooling										W/W
rpm \ °F	-20	-13	-10	0	10	14	20	30	40	41	45	50
2,000	0.93	1.04	1.09	1.26	1.46	1.54	1.67	1.90	2.13	2.15	2.24	2.35
2,500	0.89	1.01	1.06	1.22	1.40	1.48	1.60	1.83	2.08	2.10		
3,000	0.81	0.95	1.01	1.19	1.38	1.45	1.58	1.80				
3,500	0.79	0.87	0.92	1.11	1.33	1.42	1.55	1.78				

Test conditions with electronic units		EN 12900/CECOMAF	ASHRAE LBP
Condensing temperature	101N0242 101N0680	131°F	130°F
Ambient temperature		90°F	90°F
Suction gas temperature		90°F	90°F
Liquid temperature		no subcooling	90°F

Accessories for BD35F		Code number
Bolt joint for one comp.	Ø: 5/8 in.	118-1917
Bolt joint in quantities	Ø: 5/8 in.	118-1918
Snap-on in quantities	Ø: 5/8 in.	118-1919
Remote kit (without cable)		105N9210
Secop Gateway		105N9518
DC usage:	Automobile fuse, DIN 7258 12V: 15A 24V: 7.5 A Main switch min. 20A	Not deliverable from Secop
AC usage:	Fuse, 100-240V Main switch min. 6A	

Compressor speed

Electronit unit	Resistor (R1) [Ω]	Motor speed
Code number	calculated values	[rpm]
101N0242 101N0510 101N0680	0	2,000
	277	2,500
	692	3,000
101N0340 101N0420 with AEO	1523	3,500
	0	AEO
	173	2,000
	450	2,500
	865	3,000
	1696	3,500

In AEO (Adaptive Energy Optimizing) speed mode the BD compressor will always adapt its speed to the actual cooling demand.

Wire dimensions DC

Cross section [mm²]	Size		Max. length* 12V operation		Max. length* 24V operation	
	AWG	[Gauge]	[m]	[ft.]	[m]	[ft.]
2.5	12		2.5	8	5	16
4	12		4	13	8	26
6	10		6	20	12	39
10	8		10	33	20	66

*Length between battery and electronic unit

Wire dimensions AC

Cross section min. 0.75 mm² or AWG 18

Operational errors

Error code or LED flashes	Error type
	Can be read out in the software TOOL4COOL®
6	Thermostat failure (If the NTC thermistor is short-circuit or has no connection).
5	Thermal cut-out of electronic unit (If the refrigeration system has been too heavily loaded, or if the ambient temperature is high, the electronic unit will run too hot).
4	Minimum motor speed error (If the refrigeration system is too heavily loaded, the motor cannot maintain minimum speed at approximately 1,850 rpm).
3	Motor start error (The rotor is blocked or the differential pressure in the refrigeration system is too high (>5 bar)).
2	Too many start attempts or fan over current (Too many compressor or fan starts in short time or fan current higher than 0.5A _{avg}).
1	Battery protection cut-out (The voltage is outside the cut-out setting).

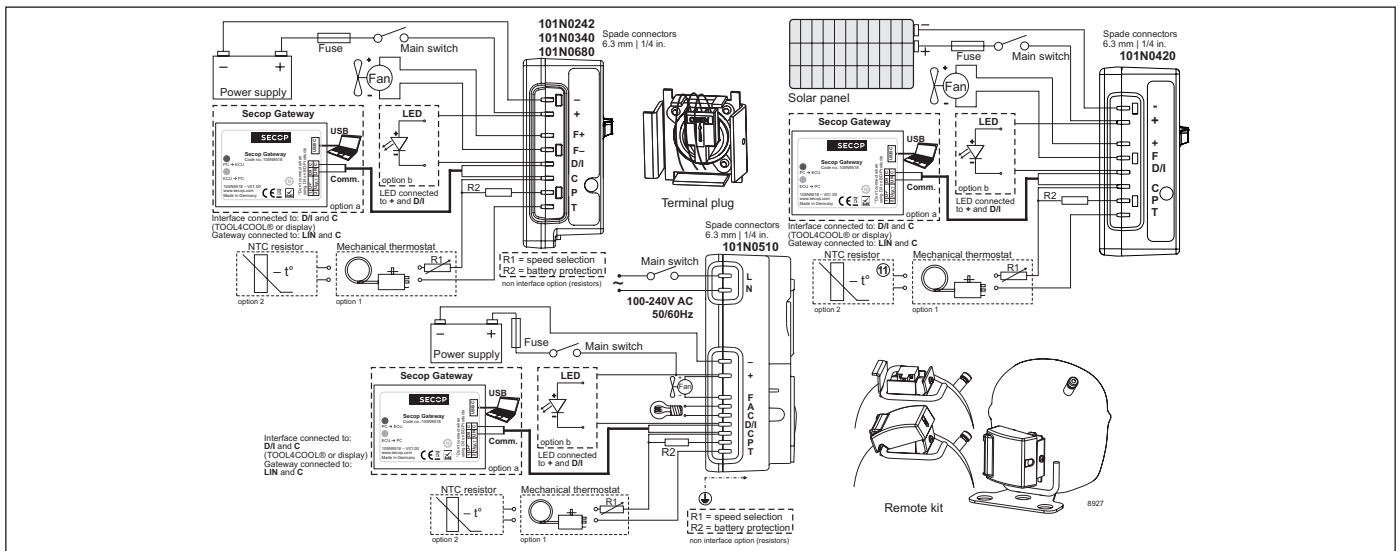

Performance Data with Refrigerant R1234yf

Capacity (ASHRAE LBP)		12V DC, static cooling										BTU/h
rpm \ °F	-20	-13	-10	0	10	14	20	30	40	41	45	50
2,000	82.5	110	123	172	230	256	297	374	459	469	506	555
2,500	92.4	131	150	216	293	326	379	475	579	590	635	
3,000	123	158	175	241	322	359	420	538				
3,500	142	175	193	266	362	406	478	616				

Capacity (EN 12900 Household/CECOMAF)		12V DC, static cooling										watt
rpm \ °F	-20	-13	-10	0	10	14	20	30	40	41	45	50
2,000	18.6	24.8	27.8	38.8	51.9	57.7	67.0	84.1	103	105	114	125
2,500	20.8	29.6	33.8	48.9	66.2	73.7	85.6	107	131	133	143	
3,000	27.5	35.3	39.2	53.9	72.1	80.5	94.3	121				
3,500	31.9	39.3	43.3	59.7	81.1	91.0	107	138				

Power consumption		12V DC, static cooling										watt
rpm \ °F	-20	-13	-10	0	10	14	20	30	40	41	45	50
2,000	19.0	22.9	24.5	29.6	34.6	36.5	39.5	44.8	50.7	51.4	54.0	57.5
2,500	23.9	29.7	31.9	39.0	45.4	47.9	51.6	58.0	65.0	65.7	68.8	
3,000	30.4	34.6	36.6	44.3	52.8	56.3	61.5	70.0				
3,500	36.0	41.3	43.7	52.5	62.0	65.9	72.0	82.2				

Current consumption (for 24V applications the following must be halved)												A
rpm \ °F	-20	-13	-10	0	10	14	20	30	40	41	45	50
2,000	1.51	1.87	2.02	2.47	2.89	3.05	3.30	3.73	4.20	4.25	4.46	4.74
2,500	1.99	2.47	2.66	3.25	3.79	4.00	4.31	4.84	5.42	5.48	5.74	
3,000	2.49	2.88	3.05	3.70	4.39	4.67	5.10	5.81				
3,500	2.99	3.42	3.63	4.36	5.15	5.48	5.99	6.85				

EER (ASHRAE LBP)		12V DC, static cooling										BTU/Wh
rpm \ °F	-20	-13	-10	0	10	14	20	30	40	41	45	50
2,000	4.06	4.57	4.80	5.59	6.43	6.77	7.29	8.16	9.04	9.12	9.47	9.90
2,500	3.59	4.19	4.44	5.28	6.14	6.49	7.02	7.93	8.84	8.94	9.31	
3,000	3.68	4.27	4.51	5.25	5.98	6.29	6.77	7.68				
3,500	3.55	3.91	4.10	4.83	5.66	6.01	6.55	7.48				

COP (EN 12900 Household/CECOMAF)		12V DC, static cooling										W/W
rpm \ °F	-20	-13	-10	0	10	14	20	30	40	41	45	50
2,000	0.91	1.03	1.08	1.26	1.44	1.52	1.63	1.83	2.02	2.04	2.11	2.21
2,500	0.81	0.94	1.00	1.19	1.38	1.46	1.58	1.78	1.98	2.00		
3,000	0.82	0.95	1.01	1.17	1.34	1.40	1.51	1.72				
3,500	0.80	0.88	0.92	1.08	1.26	1.34	1.46	1.67				

Test conditions with electronic units		EN 12900/CECOMAF	ASHRAE LBP
Condensing temperature	101N0242 101N0680	131°F	130°F
Ambient temperature		90°F	90°F
Suction gas temperature		90°F	90°F
Liquid temperature		no subcooling	90°F

Accessories for BD35F		Code number
Bolt joint for one comp.	Ø: 5/8 in.	118-1917
Bolt joint in quantities	Ø: 5/8 in.	118-1918
Snap-on in quantities	Ø: 5/8 in.	118-1919
Remote kit (without cable)		105N9210
Secop Gateway		105N9518
DC usage:	Automobile fuse, DIN 7258 12V: 15A 24V: 7.5 A Main switch min. 20A	Not deliverable from Secop
AC usage:	Fuse, 100-240V Main switch min. 6A	

Compressor speed

Electronit unit	Resistor (R1) [Ω]	Motor speed
Code number	calculated values	[rpm]
101N0242 101N0510 101N0680	0	2,000
	277	2,500
	692	3,000
101N0340 101N0420 with AEO	1523	3,500
	0	AEO
	173	2,000
	450	2,500
	865	3,000
	1696	3,500

In AEO (Adaptive Energy Optimizing) speed mode the BD compressor will always adapt its speed to the actual cooling demand.

Wire dimensions DC

Cross section	Size		Max. length* 12V operation		Max. length* 24V operation	
	AWG	[mm²]	[m]	[ft.]	[m]	[ft.]
2.5	12	2.5	8	5	16	
4	12	4	13	8	26	
6	10	6	20	12	39	
10	8	10	33	20	66	

*Length between battery and electronic unit

Wire dimensions AC

Cross section min. 0.75 mm² or AWG 18

Operational errors

Error code or LED flashes	Error type
	Can be read out in the software TOOL4COOL®
6	Thermostat failure (If the NTC thermistor is short-circuit or has no connection).
5	Thermal cut-out of electronic unit (If the refrigeration system has been too heavily loaded, or if the ambient temperature is high, the electronic unit will run too hot).
4	Minimum motor speed error (If the refrigeration system is too heavily loaded, the motor cannot maintain minimum speed at approximately 1,850 rpm).
3	Motor start error (The rotor is blocked or the differential pressure in the refrigeration system is too high (>5 bar)).
2	Too many start attempts or fan over current (Too many compressor or fan starts in short time or fan current higher than 0.5A _{avg}).
1	Battery protection cut-out (The voltage is outside the cut-out setting).

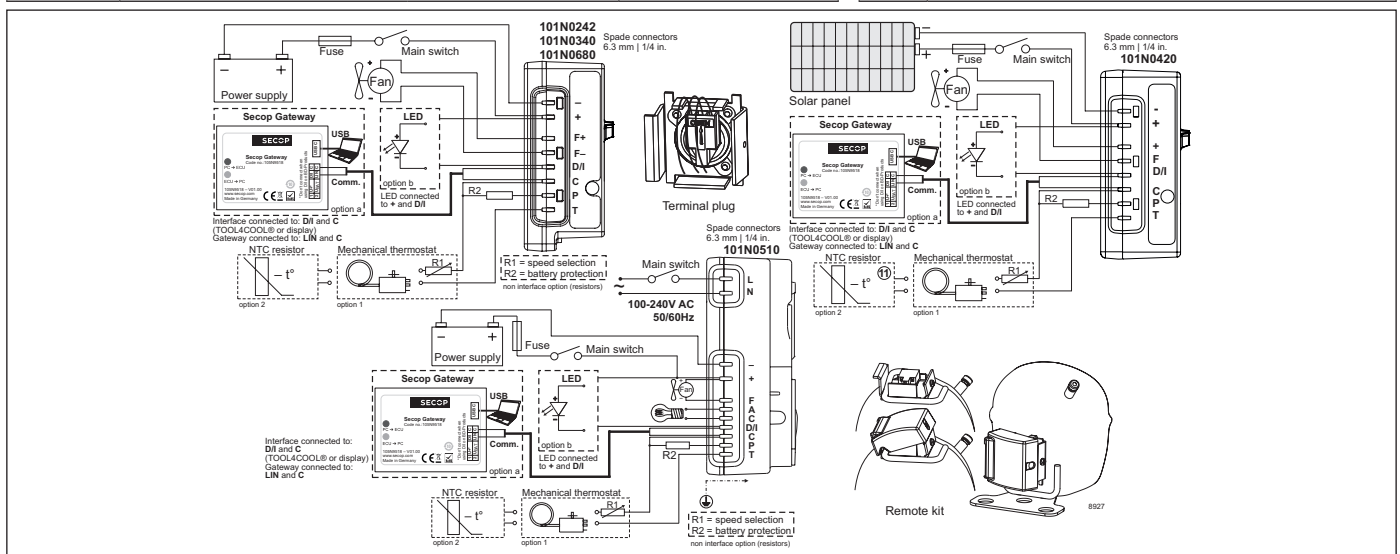

Secop accepts no responsibility for possible errors in catalogs, brochures, and other printed material. Secop reserves the right to alter its products without notice. This also applies to products already on order provided that such alterations can be made without substantial changes being necessary to specifications already agreed. All trademarks in this material are the property of the respective companies. Secop and the Secop logotype are trademarks of Secop GmbH. All rights reserved. www.secop.com



Instructions for Electronic Units
are available for download on
www.secop.com



BD Compressors



Service/Repair

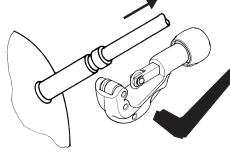

BD Nano



**! max. 150°C/302°F !
at socket**
brazing solder: silver with flux

Do not heat up the bottom of the discharge connector directly.
Do not braise longer than 10 seconds and wait for 5 minutes for the next soldering attempt (Product Bulletin DES.N.101.M1).

BD Micro

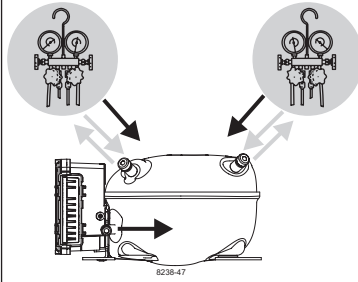

BD P-Housing

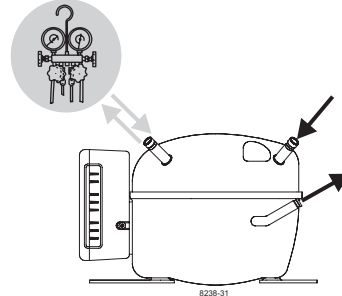

BD T-Housing

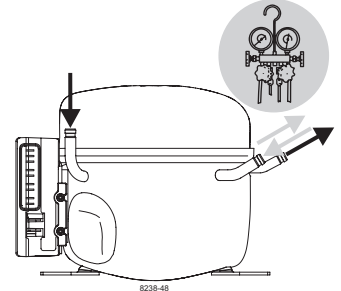

Secop accepts no responsibility for possible errors in catalogs, brochures, and other printed material. Secop reserves the right to alter its products without notice. This also applies to products already on order provided that such alterations can be made without subsequential changes being necessary to specifications already agreed. All trademarks in this material are the property of the respective companies. Secop and the Secop logotype are trademarks of Secop GmbH. All rights reserved. www.secop.com