

Single Pack SCE21CNLX 220-240V 50Hz CSIR

Codice Imballo Singolo: **195B4567**

Posizione	Titolo	Codice	Quantità
1	Compressor SCE21CNLX	104H8164	1
2	Starting capacitor (80 μ F 220V, 6.3mm)	117U5017	1
3	Cord relief	103N1004	1
4	Bolt joint for one compressor M6 \varnothing 16mm	118-1917	1

Secop GmbH • Lise-Meitner-Straße 29 • 24941 Flensburg, Germany • Tel: +49 46149410 • www.secop.com

Secop non si assume alcuna responsabilità per eventuali errori presenti in cataloghi, brochure e altro materiale stampato. Secop si riserva il diritto di modificare i propri prodotti senza preavviso. Ciò vale anche per i prodotti già ordinati, a condizione che tali modifiche possano essere apportate senza che siano necessarie modifiche successive alle specifiche già concordate. Tutti i marchi presenti in questo materiale sono di proprietà delle rispettive aziende. Secop e il logo Secop sono marchi di Secop GmbH. Tutti i diritti sono riservati.

Model

Designation	SCE21CNLX	220-240V/50Hz 1~	Sales code:	104H8164
-------------	------------------	------------------	-------------	-----------------

Compressor design

Oil type	Polyolester	Refrigerant(s)	R290
Oil viscosity	32cSt	Displacement	20,95cm ³ / 1,28cu.in
Oil quantity	550cm ³ / 18,6fl.oz	Compressors on pallet	80
Refr. charge - tech. limit	500g / 17,6oz		
Free gas volume comp.	1460cm ³ / 49,4fl.oz		
Weight	14,2kg / 31,3lbs		
Motor protection	external		
Winding resistance main	3,57Ω (at 25°C)		
Winding resistance aux	18,6Ω (at 25°C)		
Max. winding temp.	135°C / 275°F		
Max. discharge temp.	140°C / 284°F		



General - Configurations with SCE21CNLX

	Conf. 1
Motorconfiguration	CSIR
Power supply (nominal)	220-230V/50Hz
Number of phases	1
Voltage range	207-242V
Approvals	VDE, CCC, EAC
Starting torque	HST
Note	Protector, relay and cover are included and pre-assembled to compressor.

Applications with SCE21CNLX

	Conf. 1
Refrigerant	R290
Application	LBP
System cooling	fan 3m/s
Hot gas defrost	OK
Long interval pull down	-/-

Electrical data - Configurations with SCE21CNLX

	Conf. 1
Starting device type	relay
Run capacitor	-/-
Start capacitor	80μF
LRA (locked rotor amps / 4s/ U(N))	19,67A
RLA (rated load amps / 1s/ U(N))	3,76A
Cut in current (U(N))	19,67A

Model

Designation

SCE21CNLX

220-240V/50Hz 1~

Sales code:

104H8164

Compressor dimensions

Housing	A Height	219mm / 8,62in
	B Height	213mm / 8,39in
	C Length shell	218mm / 8,58in
	D Length w. cover	255mm / 10,04in
	E Width	151mm / 5,94in

Connectors		Suction	Discharge	Process
		X	Y	Z
Diameter	[mm]	øi 10,11-10,29	øi 6,11-6,29	øi 6,11-6,29
(i:inside, o:outside)	[in]	øi 0,4-0,41	øi 0,24-0,25	øi 0,24-0,25
Material		copper	copper	copper
Horizontal angle	±2°	37°	37°	143°
Vertical angle	±2°	30°	0°	150°
Position l/h/w	[mm]	107/193/55	115/110/63	-107/193/55
	[in]	4,2/7,6/2,2	4,5/4,3/2,5	-4,2/7,6/2,2
Straight tube l.	[mm]	12	12	12
	[in]	0,5	0,5	0,5



Compressor fixation

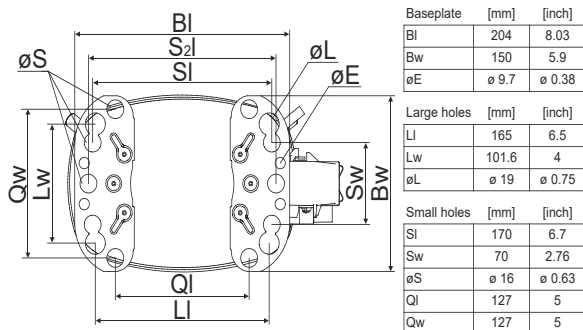

Bolt joint



Snap-on

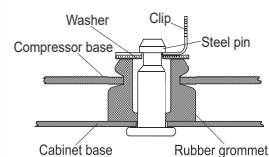

Mounting accessories

Mounting accessories	one comp.	multi pack
Bolt joint M6 ø16mm	118-1917	118-1918
Bolt joint ø1/4" ø16mm	118-1946	
Bolt joint ø1/4" ø19mm	118-1949	
Snap-on ø7,3 ø16mm	118-1947	118-1919

Application notes

Provision for PE Grounding is located at the PE Stamp on the compressor

Model

Designation	SCE21CNLX	220-230V/50Hz	Conf. 1	Sales code:	104H8164
-------------	------------------	----------------------	----------------	-------------	-----------------

Configuration

Motor configuration	CSIR
Power supply (nominal)	220-230V/50Hz 1~
Refrigerant	R290
Application	LBP
Voltage range	207-242V
Starting torque	HST
Approvals	VDE
	CCC
	EAC

Electrical accessories / wiring diagram

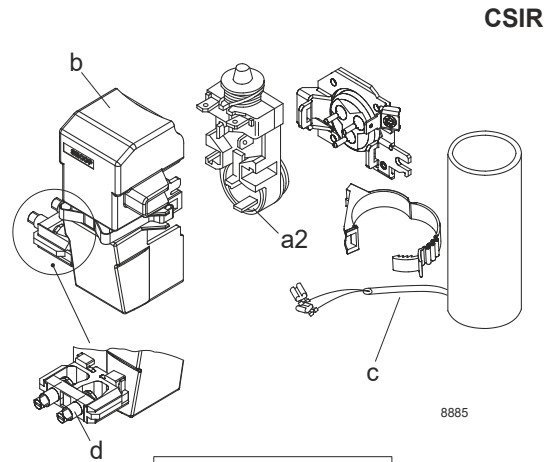

Ambient/ machine room temperatures minimum /maximum

Ambient temperature range:	10 - 38°C / 50 - 101°F
Machine room temperature range:	10 - 43°C / 50 - 110°F
Compressor cooling:	fan 3m/s

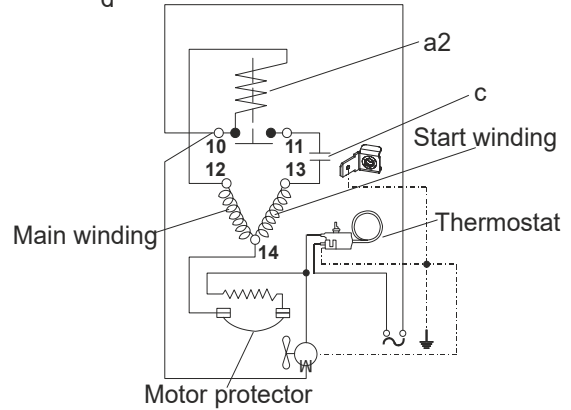

Operation pressure range

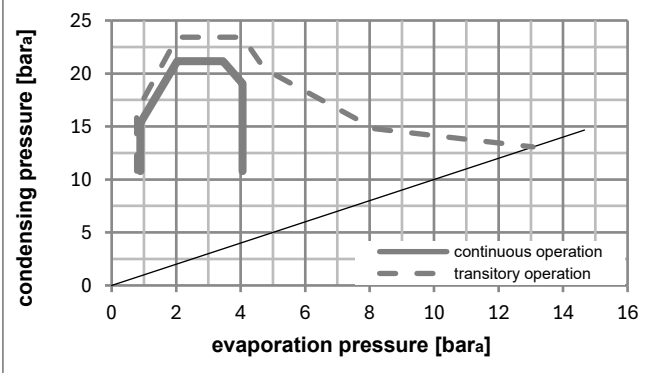
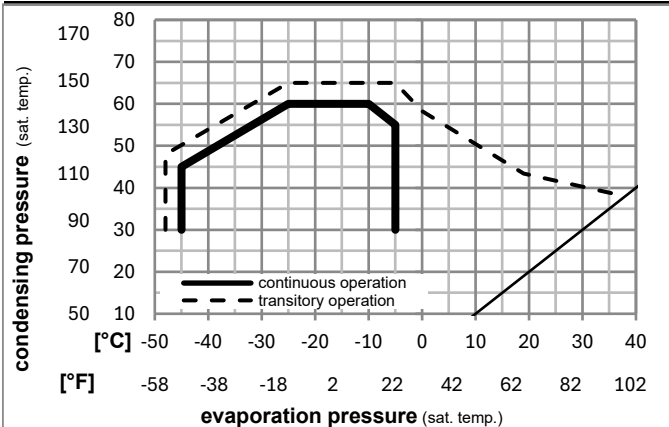

Components (relay (a2)+ cover (b): pre-assembled)

a2	assy. relay + ext. protector (T1102)	117U7400
c	start capacitor (80µF)	117U5017
d	cord relief	103N1004
b	plastic cover + clamp	117U1033

Noise emission

Operation pressures:	pe: -25°C / -13°F
	pc: 45°C / 113°F
Motor speed appr.:	2900rpm
Lw(A):	57dB(A)

Model

Designation **SCE21CNLX** **220-230V/50Hz** Conf. 1 Sales code: **104H8164**

Optimization + standard conditions

R290, 220V/50Hz, CSIR, fan 3m/s, VDE, CCC, EAC

		Evaporating pressure (saturation temperature)				Condensing pressure (saturation temperature)			Return gas temp.		Liquid temp.		Cooling capacity			COP	EER	Power consumption		
		pe	pc	RGT	Tliq	[W]	[Btu/h]	[kcal/h]	[W/W]	[Btu/Wh]	[kcal/Wh]	P1	I	Current consumption		Ref. mass flow				
[°C]	[°F]	[°C]	[°F]	[°C]	[°F]	[W]	[Btu/h]	[kcal/h]	[W/W]	[Btu/Wh]	[kcal/Wh]	[W]	[A]	[A]	[kg/h]					
-23	-10	54	130	32	90	937,4	3201	806,8	1,49	5,08	1,28	629,8	3,70	9,49					ASHRAE LBP	
-25	-13	55	131	32	90	696,7	2379	599,5	1,16	3,96	1,00	601,2	3,59	8,67					cecomaf LBP	
-35	-31	40	104	20	68	545,5	1863	469,5	1,21	4,15	1,05	449,1	2,87	6,23					EN12900 LBP	
-23	-10	49	120	4,4	40	783,9	2677	674,6	1,28	4,36	1,10	614,5	3,61	10,86					ARI540 LBP	
-23	-10	41	105	32	90	1074,3	3669	924,5	1,84	6,29	1,58	583,7	3,36	10,88					AHAM LBP	
-35	-31	45	113	32	90	506,3	1729	435,7	1,12	3,83	0,96	451,9	2,94	5,67					opt	

Performance tables

R290, 220V/50Hz, CSIR, fan 3m/s, VDE, CCC, EAC

	pe		Cooling capacity			COP	EER	P1	I	m	
	[°C]	[°F]	[W]	[Btu/h]	[kcal/h]	[W/W]	[Btu/Wh]	[kcal/Wh]	[W]	[A]	[kg/h]
[°C / °F]	-45	-49	255,8	874	220,2	0,71	2,44	0,61	358,7	2,67	2,85
cond. pressure	-35	-31	506,3	1729	435,7	1,12	3,83	0,96	451,9	2,94	5,67
pc= 45/113	-30	-22	670,8	2291	577,3	1,31	4,47	1,13	513,0	3,15	7,54
return gas temp.	-25	-13	862,5	2946	742,3	1,49	5,08	1,28	579,3	3,40	9,73
RGT= 32/90	-20	-4	1082,3	3696	931,5	1,67	5,71	1,44	647,2	3,66	12,26
liquid temp	-15	5	1331,0	4546	1145,5	1,87	6,37	1,61	713,3	3,92	15,14
Tliq= 45/113	-5	23	1918,3	6551	1650,9	2,32	7,93	2,00	826,3	4,38	22,09
[°C / °F]	-45	-49	226,9	775	195,3	0,71	2,43	0,61	318,7	2,68	2,79
cond. pressure	-35	-31	402,8	1376	346,7	0,92	3,15	0,79	436,5	3,01	4,98
pc= 55/131	-30	-22	534,6	1826	460,1	1,04	3,55	0,89	514,7	3,28	6,63
return gas temp	-25	-13	696,7	2379	599,5	1,16	3,96	1,00	601,2	3,59	8,67
RGT= 32/90	-20	-4	889,8	3039	765,8	1,28	4,39	1,11	692,5	3,92	11,13
liquid temp	-15	5	1114,8	3807	959,4	1,42	4,85	1,22	785,2	4,28	14,02
Tliq= 55/131	-5	23	1663,7	5682	1431,8	1,73	5,91	1,49	961,0	4,96	21,19

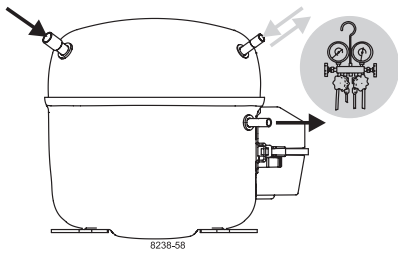

SCE Compressors

(External Protector)

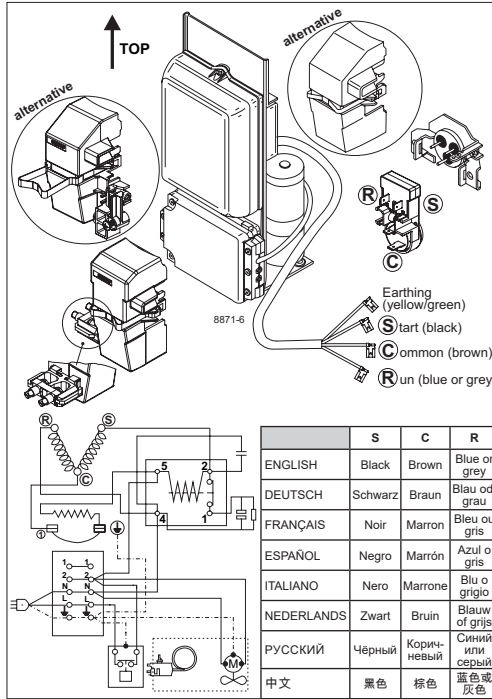

	S	C	R
ENGLISH	Black	Brown	Blue or grey
DEUTSCH	Schwarz	Braun	Blau od. grau
FRANÇAIS	Noir	Marron	Bleu ou gris
ESPAÑOL	Negro	Marrón	Azul o gris
ITALIANO	Nero	Marrone	Blu o grigio
NEDERLANDS	Zwart	Bruin	Blauw of grijs
РУССКИЙ	Чёрный	Коричневый	Синий или серый
中文	黑色	棕色	蓝色或灰色

	S	C	R
ENGLISH	Black	Brown	Blue or grey
DEUTSCH	Schwarz	Braun	Blau od. grau
FRANÇAIS	Noir	Marron	Bleu ou gris
ESPAÑOL	Negro	Marrón	Azul o gris
ITALIANO	Nero	Marrone	Blu o grigio
NEDERLANDS	Zwart	Bruin	Blauw of grijs
РУССКИЙ	Чёрный	Коричневый	Синий или серый
中文	黑色	棕色	蓝色或灰色



SCE Compressors (External Protector)



Service/Repair – R290



8545

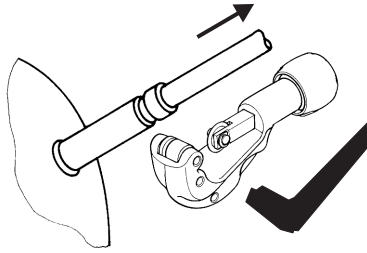

Brazing on Suction Connectors (Direct Intake)



! max. 350°C/662°F !
at socket
brazing solder: phosphor (LP7) or silver

8882

Refer to Product Bulletin:
Brazing on Suction Connectors
(SCE Compressors with Direct Suction Intake)

Secop accepts no responsibility for possible errors in catalogs, brochures, and other printed material. Secop reserves the right to alter its products without notice. This also applies to products already on order provided that such alterations can be made without subsequential changes being necessary to specifications already agreed. All trademarks in this material are the property of the respective companies. Secop and the Secop logotype are trademarks of Secop GmbH. All rights reserved. www.secop.com