

## Single Pack SCE15MNX 208-230V 60Hz CSIR

Codice Imballo Singolo: **195B4671**

Posizione	Titolo	Codice	Quantità
1	Compressor SCE15MNX	104H8589	1
2	Starting capacitor (60 $\mu$ F 260V, 6.3mm)	117U5076	1
3	Bolt joint for one compressor   M6   $\varnothing$ 16mm	118-1917	1

**Secop GmbH** • Lise-Meitner-Straße 29 • 24941 Flensburg, Germany • Tel: +49 46149410 • [www.secop.com](http://www.secop.com)

Secop non si assume alcuna responsabilità per eventuali errori presenti in cataloghi, brochure e altro materiale stampato. Secop si riserva il diritto di modificare i propri prodotti senza preavviso. Ciò vale anche per i prodotti già ordinati, a condizione che tali modifiche possano essere apportate senza che siano necessarie modifiche successive alle specifiche già concordate. Tutti i marchi presenti in questo materiale sono di proprietà delle rispettive aziende. Secop e il logo Secop sono marchi di Secop GmbH. Tutti i diritti sono riservati.

## Model

Designation	<b>SCE15MNX</b>	208-230V/60Hz 1~	Sales code:	<b>104H8589</b>
-------------	-----------------	------------------	-------------	-----------------

## Compressor design

Oil type	Polyolester	Refrigerant(s)	<b>R290</b>
Oil viscosity	32cSt	Displacement	15,28cm <sup>3</sup> / 0,93cu.in
Oil quantity	541cm <sup>3</sup> / 18,3fl.oz	Compressors on pallet	80
Refr. charge - tech. limit	450g / 15,9oz		
Free gas volume comp.	1460cm <sup>3</sup> / 49,4fl.oz		
Weight	14,2kg / 31,3lbs		
Motor protection	external		
Winding resistance main	3,1Ω (at 25°C)		
Winding resistance aux	15,2Ω (at 25°C)		
Max. winding temp.	125°C / 257°F		
Max. discharge temp.	130°C / 266°F		



## General - Configurations with SCE15MNX

	<b>Conf. 1</b>
Motorconfiguration	CSIR
Power supply (nominal)	208-230V/60Hz
Number of phases	1
Voltage range	187-253V
Approvals	UL, KC, CB
Starting torque	HST
Note	Protector, relay and cover are included and pre-assembled to compressor.

## Applications with SCE15MNX

	<b>Conf. 1</b>
Refrigerant	R290
Application	MBP
System cooling	fan 3m/s
Hot gas defrost	OK
Long interval pull down	OK

## Electrical data - Configurations with SCE15MNX

	<b>Conf. 1</b>
Starting device type	relay
Run capacitor	-/-
Start capacitor	60μF
LRA (locked rotor amps / 4s/ U(N))	23,6A
RLA (rated load amps / 1s/ U(N))	4,5A
Cut in current (U(N))	23,6A

## Model

Designation

**SCE15MNX**

208-230V/60Hz 1~

Sales code:

**104H8589**

## Compressor dimensions

Housing	A Height	219mm / 8,62in
	B Height	213mm / 8,39in
	C Length shell	218mm / 8,58in
	D Length w. cover	255mm / 10,04in
	E Width	151mm / 5,94in

Connectors		Suction	Discharge	Process
		X	Y	Z
Diameter	[mm]	øi 9,54-9,72	øi 6,41-6,59	øi 6,41-6,59
	(i:inside, o:outside) [in]	øi 0,38-0,38	øi 0,25-0,26	øi 0,25-0,26
Material		copper	copper	copper
Horizontal angle	±2°	37°	37°	143°
Vertical angle	±2°	30°	0°	150°
Position l/h/w	[mm]	107/193/55	115/110/63	-107/193/55
	[in]	4,2/7,6/2,2	4,5/4,3/2,5	-4,2/7,6/2,2
Straight tube l.	[mm]	12	12	12
	[in]	0,5	0,5	0,5



## Compressor fixation

Baseplate	[mm]	[inch]
BI	204	8.03
Bw	150	5.9
øE	ø 9.7	ø 0.38

  

Large holes	[mm]	[inch]
LI	165	6.5
Lw	101.6	4
øL	ø 19	ø 0.75

  

Small holes	[mm]	[inch]
SI	170	6.7
Sw	70	2.76
øS	ø 16	ø 0.63
QI	127	5
Qw	127	5

## Bolt joint

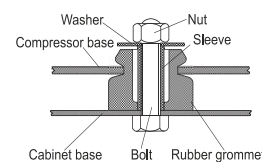

## Snap-on

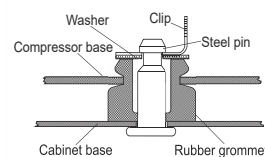

## Mounting accessories

	one comp.	multi pack
Bolt joint   M6   ø16mm	118-1917	118-1918
Bolt joint   ø1/4"   ø16mm	118-1946	
Bolt joint   ø1/4"   ø19mm	118-1949	
Snap-on   ø7,3   ø16mm	118-1947	118-1919

## Application notes

Provision for PE Grounding is located at the PE Stamp on the compressor

## Model

Designation	<b>SCE15MNX</b>	<b>208-230V/60Hz</b>	<b>Conf. 1</b>	Sales code:	<b>104H8589</b>
-------------	-----------------	----------------------	----------------	-------------	-----------------

## Configuration

Motor configuration	CSIR
Power supply (nominal)	208-230V/60Hz 1~
Refrigerant	R290
Application	MBP
Voltage range	187-253V
Starting torque	HST
Approvals	UL
	KC
	CB

## Electrical accessories / wiring diagram

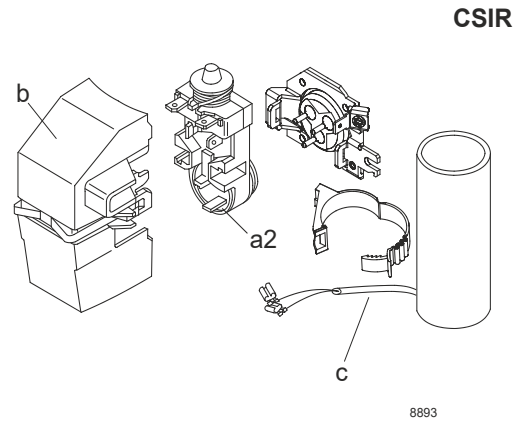

## Ambient/ machine room temperatures minimum /maximum

Ambient temperature range:	10 - 43°C / 50 - 110°F
Machine room temperature range:	10 - 48°C / 50 - 119°F
Compressor cooling:	fan 3m/s

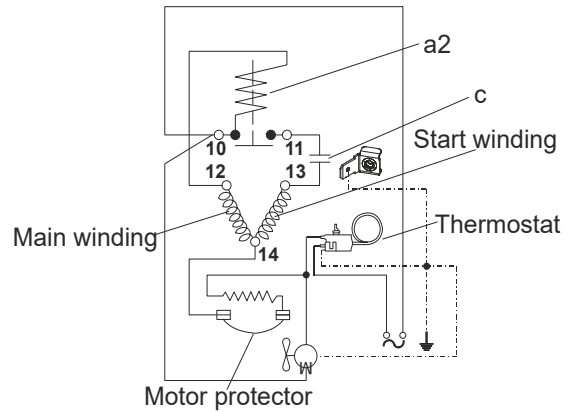

## Operation pressure range

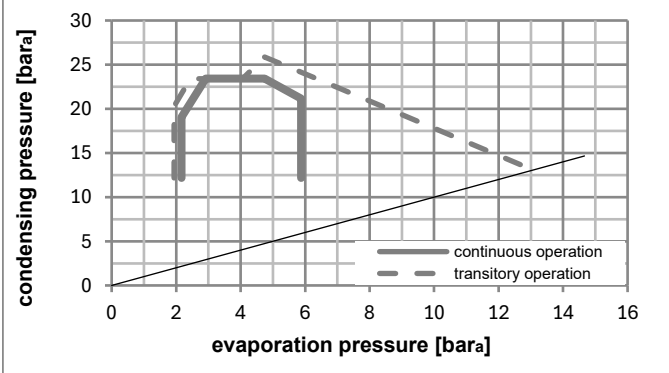
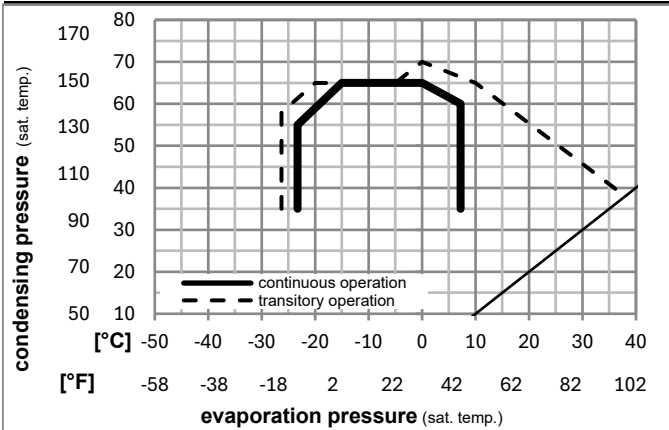

## Components (relay (a2)+ cover (b): pre-assembled)

a2	assy. relay + ext. protector (T1116)	117U7401
c	start capacitor (60μF, 6.3mm, 82kOhm)	117U5076
b	plastic cover + clamp	117U1021

## Noise emission

Operation pressures:	pe: -10°C / 14°F
	pc: 45°C / 113°F
Motor speed appr.:	3500rpm
Lw(A):	60dB(A)

### Model

Designation **SCE15MNX** **208-230V/60Hz** Conf. 1 Sales code: **104H8589**

### Optimization + standard conditions

R290, 230V/60Hz, CSIR, fan 3m/s, UL, KC, CB

		Evaporating pressure (saturation temperature)				Condensing pressure (saturation temperature)			Return gas temp.		Liquid temp.		Cooling capacity			COP	EER		Power consumption			ASHRAE MBP
		pe	pc	RGT	Tliq	[W]	[Btu/h]	[kcal/h]	[W/W]	[Btu/Wh]	[kcal/Wh]	P1	I	Current consumption		Ref. mass flow						
[°C]	[°F]	[°C]	[°F]	[°C]	[°F]	[W]	[Btu/h]	[kcal/h]	[W/W]	[Btu/Wh]	[kcal/Wh]	[W]	[A]	[A]	[A]	[kg/h]						
-7	20	54	130	35	95	1534,9	5242	1321,0	2,03	6,94	1,75	755,3	4,19	4,19	17,51							
-10	14	55	131	32	90	1209,1	4129	1040,6	1,70	5,79	1,46	713,2	4,04	4,04	15,29	cecomaf MBP						
-10	14	45	113	20	68	1360,1	4645	1170,5	2,01	6,86	1,73	677,5	3,91	3,91	16,70	EN12900 MBP						
-7	20	49	120	18	65	1448,7	4947	1246,7	1,98	6,76	1,70	731,9	4,11	4,11	18,81	ARI540 MBP						
-10	14	45	113	32	90	1415,9	4836	1218,6	2,09	7,14	1,80	677,5	3,91	3,91	16,20	opt						
-25	-13	45	113	32	90	714,1	2439	614,5	1,45	4,97	1,25	491,1	3,32	3,32	8,05	opt						

### Performance tables

R290, 230V/60Hz, CSIR, fan 3m/s, UL, KC, CB

	pe		Cooling capacity			COP	EER		P1	I	m
	[°C]	[°F]	[W]	[Btu/h]	[kcal/h]	[W/W]	[Btu/Wh]	[kcal/Wh]	[W]	[A]	[kg/h]
[°C / °F]	-25	-13	714,1	2439	614,5	1,45	4,97	1,25	491,1	3,32	8,05
cond. pressure	-23	-10	782,7	2673	673,6	1,53	5,21	1,31	513,2	3,38	8,84
pc= 45/113	-15	5	1158,7	3957	997,2	1,87	6,38	1,61	620,4	3,72	13,18
return gas temp.	-9	15	1446,2	4939	1244,6	2,12	7,23	1,82	683,4	3,93	16,56
RGT= 32/90	-4	25	1769,6	6043	1522,9	2,41	8,23	2,07	734,0	4,10	20,41
liquid temp	0	32	2020,2	6899	1738,6	2,66	9,08	2,29	759,7	4,19	23,43
Tliq= 45/113	7,2	45	2546,0	8695	2191,1	3,26	11,15	2,81	780,1	4,28	29,91
[°C / °F]	-25	-13	567,4	1938	488,3	1,15	3,93	0,99	492,8	3,30	7,07
cond. pressure	-23	-10	629,8	2151	542,0	1,22	4,16	1,05	517,5	3,38	7,85
pc= 55/131	-15	5	972,8	3322	837,2	1,52	5,17	1,30	642,1	3,80	12,23
return gas temp	-9	15	1237,0	4225	1064,6	1,72	5,86	1,48	720,7	4,07	15,66
RGT= 32/90	-4	25	1536,1	5246	1322,0	1,94	6,64	1,67	790,4	4,31	19,60
liquid temp	0	32	1769,1	6042	1522,5	2,13	7,27	1,83	831,4	4,46	22,72
Tliq= 55/131	7,2	45	2260,8	7721	1945,7	2,56	8,73	2,20	884,6	4,65	29,46

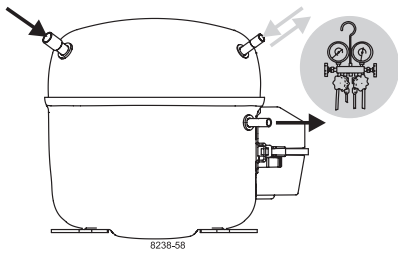

# SCE Compressors

## (External Protector)

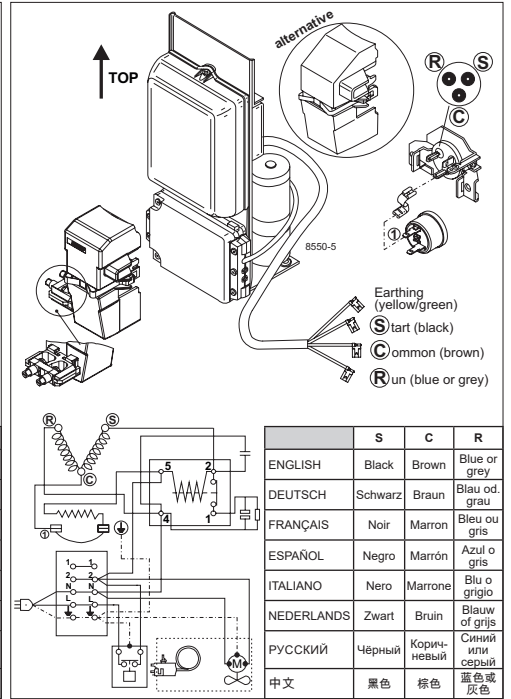
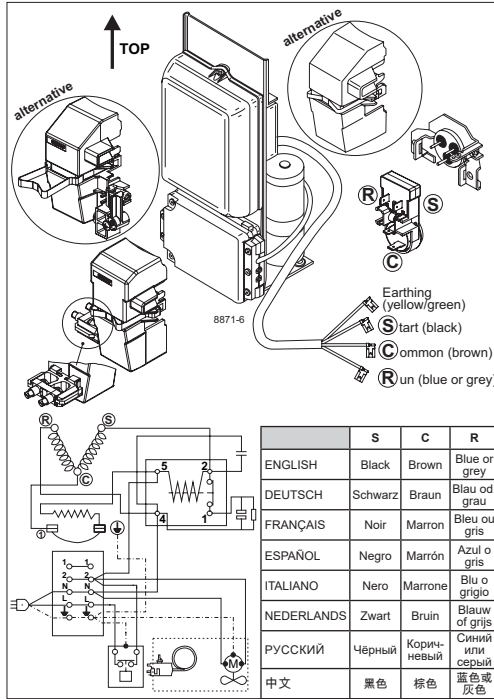

	S	C	R
ENGLISH	Black	Brown	Blue or grey
DEUTSCH	Schwarz	Braun	Blau od. grau
FRANÇAIS	Noir	Marron	Bleu ou gris
ESPAÑOL	Negro	Marrón	Azul o gris
ITALIANO	Nero	Marrone	Blu o grigio
NEDERLANDS	Zwart	Bruin	Blauw of grijs
РУССКИЙ	Чёрный	Коричневый	Синий или серый
中文	黑色	棕色	蓝色或灰色

	S	C	R
ENGLISH	Black	Brown	Blue or grey
DEUTSCH	Schwarz	Braun	Blau od. grau
FRANÇAIS	Noir	Marron	Bleu ou gris
ESPAÑOL	Negro	Marrón	Azul o gris
ITALIANO	Nero	Marrone	Blu o grigio
NEDERLANDS	Zwart	Bruin	Blauw of grijs
РУССКИЙ	Чёрный	Коричневый	Синий или серый
中文	黑色	棕色	蓝色或灰色



# SCE Compressors (External Protector)



## Service/Repair – R290

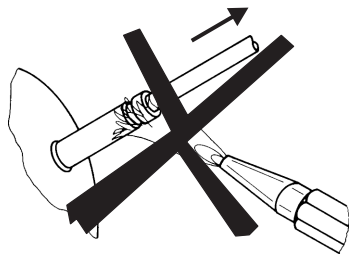

8545

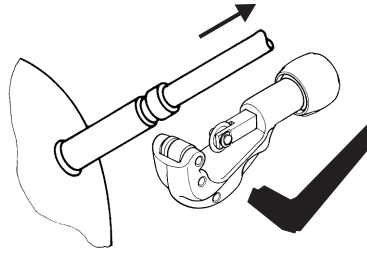

## Brazing on Suction Connectors (Direct Intake)

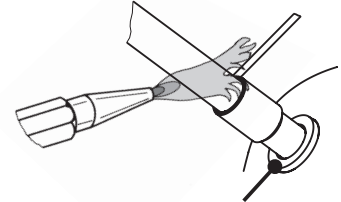

**! max. 350°C/662°F !**  
**at socket**  
 brazing solder: phosphor (LP7) or silver

8882

Refer to Product Bulletin:  
**Brazing on Suction Connectors**  
**(SCE Compressors with Direct Suction Intake)**

Secop accepts no responsibility for possible errors in catalogs, brochures, and other printed material. Secop reserves the right to alter its products without notice. This also applies to products already on order provided that such alterations can be made without subsequent changes being necessary to specifications already agreed. All trademarks in this material are the property of the respective companies. Secop and the Secop logotype are trademarks of Secop GmbH. All rights reserved. [www.secop.com](http://www.secop.com)