

## Single Pack SCE18MNX 208-230V 60Hz CSCR

Single pack code number: **195B4437**

Position	Title	Code	Amount
1	Compressor SCE18MNX	104H8879	1
2	SC starting device (550mm)	117-7807	1
3	Bolt joint for one compressor   M6   ø16mm	118-1917	1

**Secop GmbH** • Lise-Meitner-Straße 29 • 24941 Flensburg, Germany • Tel: +49 461 4941 0 • [www.secop.com](http://www.secop.com)

---

Secop accepts no responsibility for possible errors in catalogs, brochures, and other printed material. Secop reserves the right to alter its products without notice. This also applies to products already on order provided that such alterations can be made without subsequent changes being necessary to specifications already agreed. All trademarks in this material are the property of the respective companies. Secop and the Secop logotype are trademarks of Secop GmbH. All rights reserved.

---

## Model

Designation	<b>SCE18MNX</b>	208-230V/60Hz 1~	Sales code:	<b>104H8879</b>
-------------	-----------------	------------------	-------------	-----------------

## Compressor design

Oil type	Polyolester	Refrigerant(s)	<b>R290</b>
Oil viscosity	32cSt	Displacement	17,69cm <sup>3</sup> / 1,08cu.in
Oil quantity	550cm <sup>3</sup> / 18,6fl.oz	Compressors on pallet	80
Refr. charge - tech. limit	450g / 15,9oz		
Free gas volume comp.	1460cm <sup>3</sup> / 49,4fl.oz		
Weight	14,2kg / 31,3lbs		
Motor protection	external		
Winding resistance main	2,58Ω (at 25°C)		
Winding resistance aux	9,77Ω (at 25°C)		
Max. winding temp.	125°C / 257°F		
Max. discharge temp.	135°C / 275°F		



## General - Configurations with SCE18MNX

	<b>Conf. 1</b>
Motorconfiguration	CSCR
Power supply (nominal)	208-230V/60Hz
Number of phases	1
Voltage range	187-253V
Approvals	UL
Starting torque	HST
Note	Protector and cover are included and pre-assembled to compressor.

## Applications with SCE18MNX

	<b>Conf. 1</b>
Refrigerant	R290
Application	MBP
System cooling	fan 3m/s
Hot gas defrost	OK
Long interval pull down	OK

## Electrical data - Configurations with SCE18MNX

	<b>Conf. 1</b>
Starting device type	relay
Run capacitor	10μF
Start capacitor	80μF
LRA (locked rotor amps / 4s/ U(N))	26,12A
RLA (rated load amps / 1s/ U(N))	4,54A
Cut in current (U(N))	26,12A

## Model

Designation

**SCE18MNX**

208-230V/60Hz 1~

Sales code:

**104H8879**

## Compressor dimensions

Housing	A Height	219mm / 8,62in
	B Height	213mm / 8,39in
	C Length shell	218mm / 8,58in
	D Length w. cover	255mm / 10,04in
	E Width	151mm / 5,94in

Connectors		Suction	Discharge	Process
		X	Y	Z
Diameter	[mm]	øi 9,54-9,72	øi 6,41-6,59	øi 6,41-6,59
(i:inside, o:outside)	[in]	øi 0,38-0,38	øi 0,25-0,26	øi 0,25-0,26
Material		copper	copper	copper
Horizontal angle	±2°	37°	37°	143°
Vertical angle	±2°	30°	0°	150°
Position l/h/w	[mm]	107/193/55	115/110/63	-107/193/55
	[in]	4,2/7,6/2,2	4,5/4,3/2,5	-4,2/7,6/2,2
Straight tube l.	[mm]	12	12	12
	[in]	0,5	0,5	0,5



## Compressor fixation

Baseplate	[mm]	[inch]
BI	204	8.03
Bw	150	5.9
øE	ø 9.7	ø 0.38

Large holes	[mm]	[inch]
LI	165	6.5
Lw	101.6	4
øL	ø 19	ø 0.75

  

Small holes	[mm]	[inch]
SI	170	6.7
Sw	70	2.76
øS	ø 16	ø 0.63
QI	127	5
Qw	127	5

## Bolt joint



## Snap-on

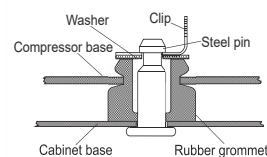

## Mounting accessories

	one comp.	multi pack
Bolt joint   M6   ø16mm	118-1917	118-1918
Bolt joint   ø1/4"   ø16mm	118-1946	
Bolt joint   ø1/4"   ø19mm	118-1949	
Snap-on   ø7,3   ø16mm	118-1947	118-1919

## Application notes

Provision for PE Grounding is located at the PE Stamp on the compressor

## Model

Designation	<b>SCE18MNX</b>	<b>208-230V/60Hz</b>	<b>Conf. 1</b>	Sales code:	<b>104H8879</b>
-------------	-----------------	----------------------	----------------	-------------	-----------------

## Configuration

Motor configuration	CSCR
Power supply (nominal)	208-230V/60Hz 1~
Refrigerant	R290
Application	MBP
Voltage range	187-253V
Starting torque	HST
Approvals	UL

## Electrical accessories / wiring diagram

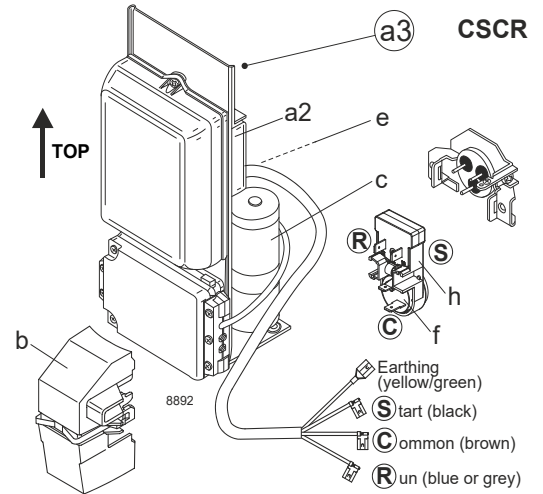

## Ambient/ machine room temperatures minimum /maximum

Ambient temperature range:	10 - 43°C / 50 - 110°F
Machine room temperature range:	10 - 48°C / 50 - 119°F
Compressor cooling:	fan 3m/s

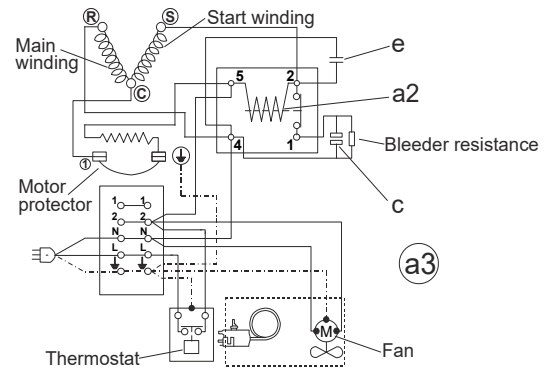

## Operation pressure range

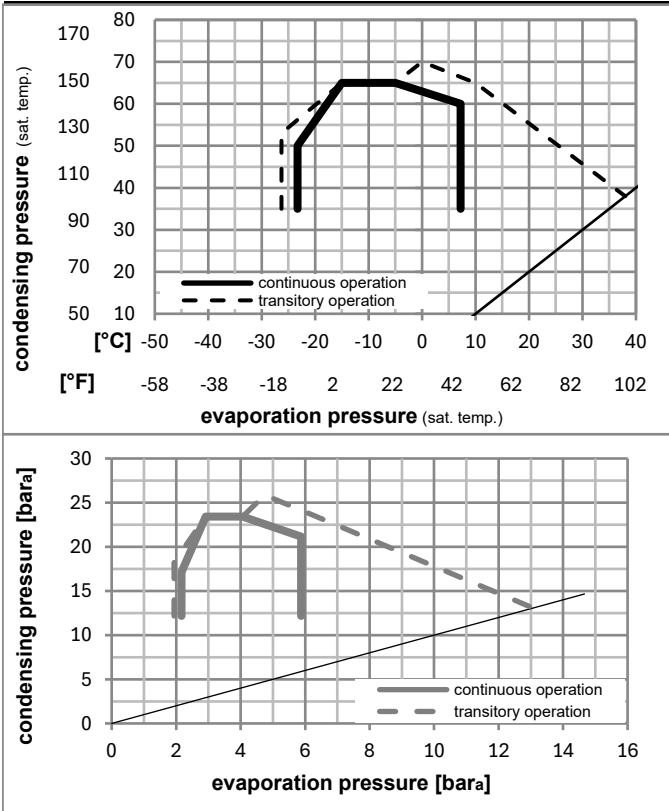

## Components (protector (f)+ holder (h)+ cover (b): pre assembled)

a3	SC starter kit (550mm)	117-7807
f / h	motor protector assy. (T0715)	117U8003
b	plastic cover + clamp	117U1021

## Alternative comp.

a2	potential relay (RVA 2GR134)	117-7445
e	run capacitor (10µF, 6.3mm)	117-7121
c	start capacitor (80µF)	117U5373

## Noise emission

Operation pressures:	pe: -10°C / 14°F
	pc: 45°C / 113°F
Motor speed appr.:	3500rpm
Lw(A):	61dB(A)

### Model

Designation **SCE18MNX** **208-230V/60Hz** Conf. 1 Sales code: **104H8879**

### Optimization + standard conditions

R290, 230V/60Hz, CSCR, fan 3m/s, UL

		Evaporating pressure (saturation temperature)				Cooling capacity			COP	EER	Power consumption				
		Condensing pressure (saturation temperature)				Return gas temp.					Current consumption				
		Liquid temp.				Cooling capacity					Ref. mass flow				
		pe	pc	RGT	Tliq	[W]	[Btu/h]	[kcal/h]	[W/W]	[Btu/Wh]	[kcal/Wh]	P1	I	m	
[°C]	[°F]	[°C]	[°F]	[°C]	[°F]	[W]	[Btu/h]	[kcal/h]	[W/W]	[Btu/Wh]	[kcal/Wh]	[W]	[A]	[kg/h]	
[°C]	-7	54	35	46	1803,7	6160	1552,3	2,21	7,53	1,90	817,6	3,97	20,58	ASHRAE MBP	
[°F]	20	130	95	115											
[°C]	-10	55	32	55	1425,3	4868	1226,6	1,84	6,27	1,58	776,1	3,81	18,03	cecomaf MBP	
[°F]	14	131	90	131											
[°C]	-10	45	20	45	1594,3	5445	1372,1	2,18	7,46	1,88	729,8	3,57	19,58	EN12900 MBP	
[°F]	14	113	68	113											
[°C]	-7	49	18	49	1697,4	5797	1460,8	2,15	7,36	1,85	788,0	3,82	22,04	ARI540 MBP	
[°F]	20	120	65	120											
[°C]	-10	45	32	45	1659,8	5668	1428,4	2,27	7,77	1,96	729,8	3,57	18,99	opt	
[°F]	14	113	90	113											
[°C]	-25	45	32	45	850,3	2904	731,8	1,55	5,30	1,34	547,5	2,83	9,59	opt	
[°F]	-13	113	90	113											

### Performance tables

R290, 230V/60Hz, CSCR, fan 3m/s, UL

	pe		Cooling capacity			COP	EER	P1	I	m	
	[°C]	[°F]	[W]	[Btu/h]	[kcal/h]	[W/W]	[Btu/Wh]	[kcal/Wh]	[W]	[A]	[kg/h]
[°C / °F]	-25	-13	850,3	2904	731,8	1,55	5,30	1,34	547,5	2,83	9,59
cond. pressure	-23	-10	929,8	3176	800,2	1,63	5,58	1,41	568,9	2,92	10,50
pc= 45/113	-15	5	1363,9	4658	1173,8	2,02	6,92	1,74	673,6	3,34	15,52
return gas temp.	-9	15	1694,5	5787	1458,3	2,30	7,87	1,98	735,5	3,59	19,40
RGT= 32/90	-4	25	2065,6	7055	1777,7	2,63	8,98	2,26	785,5	3,78	23,82
liquid temp	0	32	2352,9	8035	2024,9	2,90	9,91	2,50	810,7	3,86	27,29
Tliq= 45/113	7,2	45	2954,5	10090	2542,7	3,56	12,16	3,06	830,0	3,91	34,71
[°C / °F]	-25	-13	682,7	2332	587,6	1,23	4,19	1,06	556,5	2,91	8,50
cond. pressure	-23	-10	755,2	2579	649,9	1,30	4,44	1,12	580,9	3,01	9,42
pc= 55/131	-15	5	1152,5	3936	991,9	1,63	5,58	1,41	705,0	3,52	14,49
return gas temp	-9	15	1457,5	4978	1254,3	1,86	6,35	1,60	783,6	3,84	18,45
RGT= 32/90	-4	25	1801,8	6154	1550,7	2,11	7,21	1,82	853,4	4,11	22,99
liquid temp	0	32	2069,7	7068	1781,2	2,31	7,90	1,99	894,3	4,26	26,58
Tliq= 55/131	7,2	45	2634,2	8996	2267,0	2,78	9,50	2,39	946,7	4,44	34,32

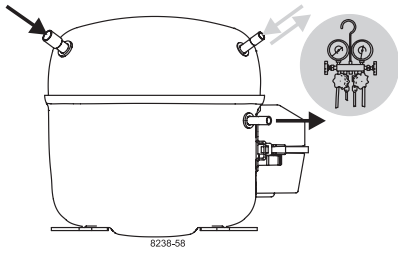

# SCE Compressors

## (External Protector)

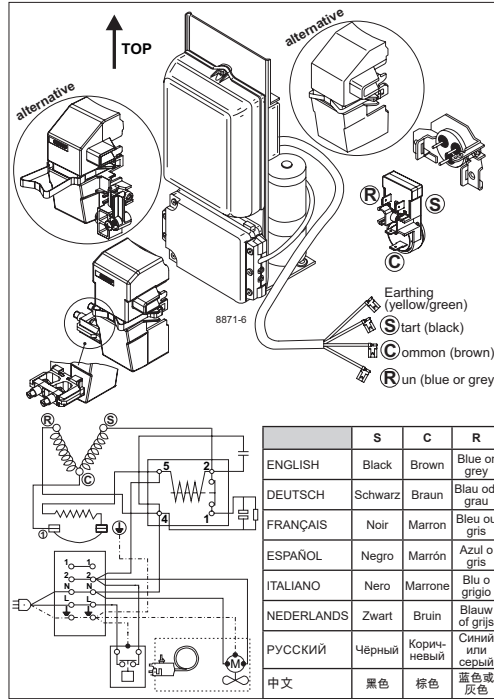

	S	C	R
ENGLISH	Black	Brown	Blue or grey
DEUTSCH	Schwarz	Braun	Blau od. grau
FRANÇAIS	Noir	Marron	Bleu ou gris
ESPAÑOL	Negro	Marrón	Azul o gris
ITALIANO	Nero	Marrone	Blu o grigio
NEDERLANDS	Zwart	Bruin	Blauw of grijs
РУССКИЙ	Чёрный	Коричневый	Синий или серый
中文	黑色	棕色	蓝色或灰色

	S	C	R
ENGLISH	Black	Brown	Blue or grey
DEUTSCH	Schwarz	Braun	Blau od. grau
FRANÇAIS	Noir	Marron	Bleu ou gris
ESPAÑOL	Negro	Marrón	Azul o gris
ITALIANO	Nero	Marrone	Blu o grigio
NEDERLANDS	Zwart	Bruin	Blauw of grijs
РУССКИЙ	Чёрный	Коричневый	Синий или серый
中文	黑色	棕色	蓝色或灰色



# SCE Compressors (External Protector)



## Service/Repair – R290

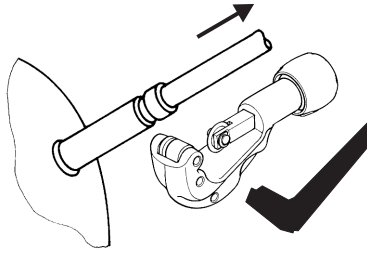

8545

## Brazing on Suction Connectors (Direct Intake)



**! max. 350°C/662°F !**  
**at socket**  
 brazing solder: phosphor (LP7) or silver

Refer to Product Bulletin:  
**Brazing on Suction Connectors**  
**(SCE Compressors with Direct Suction Intake)**

Secop accepts no responsibility for possible errors in catalogs, brochures, and other printed material. Secop reserves the right to alter its products without notice. This also applies to products already on order provided that such alterations can be made without subsequential changes being necessary to specifications already agreed. All trademarks in this material are the property of the respective companies. Secop and the Secop logotype are trademarks of Secop GmbH. All rights reserved. [www.secop.com](http://www.secop.com)