

Single Pack NLE8.0CN 115-127V 60Hz CSIR

Single pack code number: **195B4536**

Position	Title	Code	Amount
1	Compressor NLE8.0CN	105H6093	1
2	Starting relay	117U7013	1
3	Starting capacitor (240 μ F 125V, 6.3mm)	117U5023	1
4	Cord relief	103N1010	1
5	Cover	103N0492	1
6	Bolt joint for one compressor M6 \varnothing 16mm	118-1917	1

Secop GmbH • Lise-Meitner-Straße 29 • 24941 Flensburg, Germany • Tel: +49 461 4941 0 • www.secop.com

Secop accepts no responsibility for possible errors in catalogs, brochures, and other printed material. Secop reserves the right to alter its products without notice. This also applies to products already on order provided that such alterations can be made without subsequent changes being necessary to specifications already agreed. All trademarks in this material are the property of the respective companies. Secop and the Secop logotype are trademarks of Secop GmbH. All rights reserved.

Model

Designation	NLE8.0CN	115-127V/60Hz 1~	Sales code:	105H6093
-------------	-----------------	------------------	-------------	-----------------

Compressor design

Oil type	Polyolester	Refrigerant(s)	R290
Oil viscosity	32cST	Displacement	7,96cm ³ / 0,49cu.in
Oil quantity	268cm ³ / 9,1fl.oz	Compressors on pallet	80
Refr. charge - tech. limit	400g / 14,1oz		
Free gas volume comp.	2360cm ³ / 79,8fl.oz		
Weight	10,95kg / 24,1lbs		
Motor protection	1# internal		
Winding resistance main	1,99Ω (at 25°C)		
Winding resistance aux	6,22Ω (at 25°C)		
Max. winding temp.	125°C / 257°F		
Max. discharge temp.	120°C / 248°F		



General - Configurations with NLE8.0CN

	Conf. 1	Conf. 2	Conf. 3
Motorconfiguration	CSIR	RSIR	RSCR
Power supply (nominal)	115V/60Hz	115V/60Hz	115V/60Hz
Number of phases	1	1	1
Voltage range	95-135V	95-135V	95-135V
Approvals	UL, CCC	UL, CCC	UL, CCC
Starting torque	HST	LST	LST
Note	- / -		

Applications with NLE8.0CN

	Conf. 1	Conf. 2	Conf. 3
Refrigerant	R290	R290	R290
Application	LBP+MBP	LBP+MBP	LBP+MBP
System cooling	fan 3m/s	fan 3m/s	fan 3m/s
Hot gas defrost	OK	OK	OK
Long interval pull down	OK	OK	OK

Electrical data - Configurations with NLE8.0CN

	Conf. 1	Conf. 2	Conf. 3
Starting device type	relay	PTC	PTC
Run capacitor	-/-	-/-	20μF
Start capacitor	240μF	-/-	-/-
LRA (locked rotor amps / 4s)	23,1A	22,7A	22,7A
RLA (rated load amps / 1s)	4,3A	4,3A	3,88A
Cut in current	23,1A	23,2A	23,2A

Model

Designation

NLE8.0CN

115-127V/60Hz 1~

Sales code:

105H6093

Compressor dimensions

Housing	A Height	203mm / 7,99in
	B Height	197mm / 7,76in
	C Length shell	205mm / 8,07in
	D Length w. cover	254mm / 10in
	E Width	166mm / 6,54in

Connectors		Suction	Discharge	Process
		X	Y	Z
Diameter	[mm]	øi 8,11-8,29	øi 6,41-6,59	øi 6,41-6,59
	(i:inside, o:outside) [in]	øi 0,32-0,33	øi 0,25-0,26	øi 0,25-0,26
Material		copper	copper	copper
Horizontal angle	±2°	0°	0°	0°
Vertical angle	±2°	15°	21°	155°
Position l/h/w	[mm]	132/69/57	94/102/81	-109/94/72
	[in]	5,2/2,7/2,2	3,7/4/3,2	-4,3/3,7/2,8
Straight tube l.	[mm]	12	12	12
	[in]	0,5	0,5	0,5

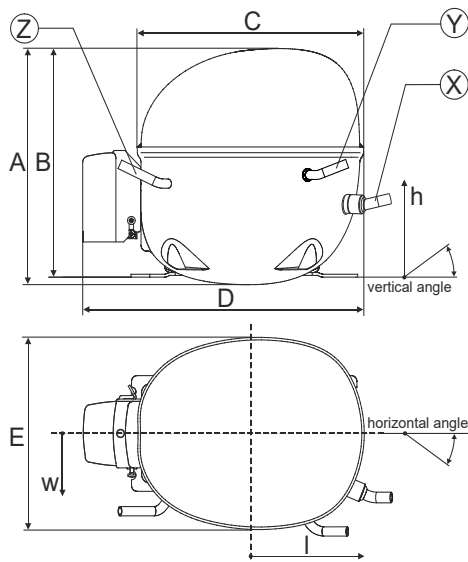

Compressor fixation



Bolt joint



Snap-on



Mounting accessories

	one comp.	multi pack
Bolt joint M6 ø16mm	118-1917	118-1918
Bolt joint ø1/4" ø16mm	118-1946	
Bolt joint ø1/4" ø19mm	118-1949	
Snap-on ø7,3 ø16mm	118-1947	118-1919

Application notes

LRA value on compressor label and datasheet may differ due to different test conditions for UL approval.

Provision for PE Grounding is located at the PE Stamp on the compressor

Model

Designation	NLE8.0CN	115V/60Hz	Conf. 1	Sales code:	105H6093
-------------	-----------------	------------------	----------------	-------------	-----------------

Configuration

Motorconfiguration	CSIR	
Power supply (nominal)	115V/60Hz 1~	
Refrigerant	R290	
Application	LBP+MBP	
Voltage range	95-135V	
Starting torque	HST	
Approvals	UL	SA3693
	CCC	

Electrical accessories / wiring diagram

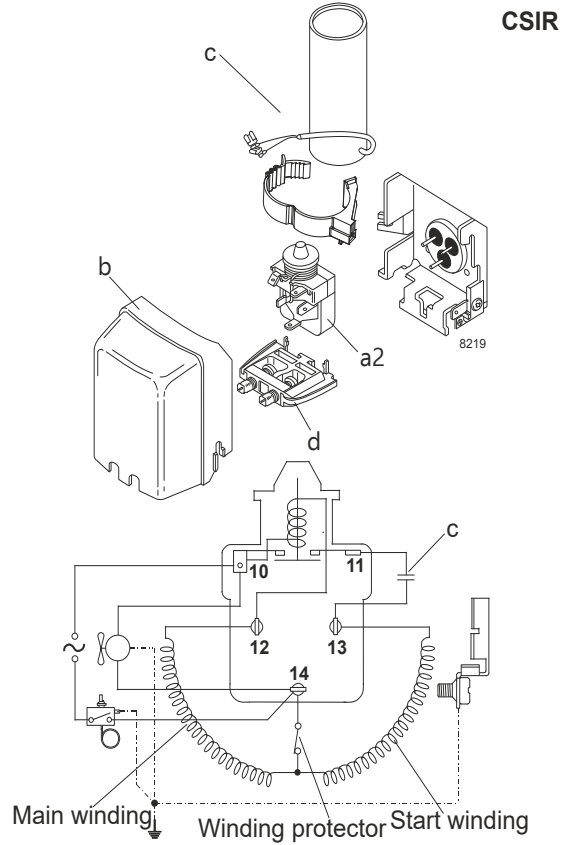

Ambient/ machine room temperatures minimum /maximum

Ambient temperature range: 10 - 43°C / 50 - 110°F

Machine room temperature range: 10 - 48°C / 50 - 119°F

Compressor cooling: fan 3m/s

Operation pressure range

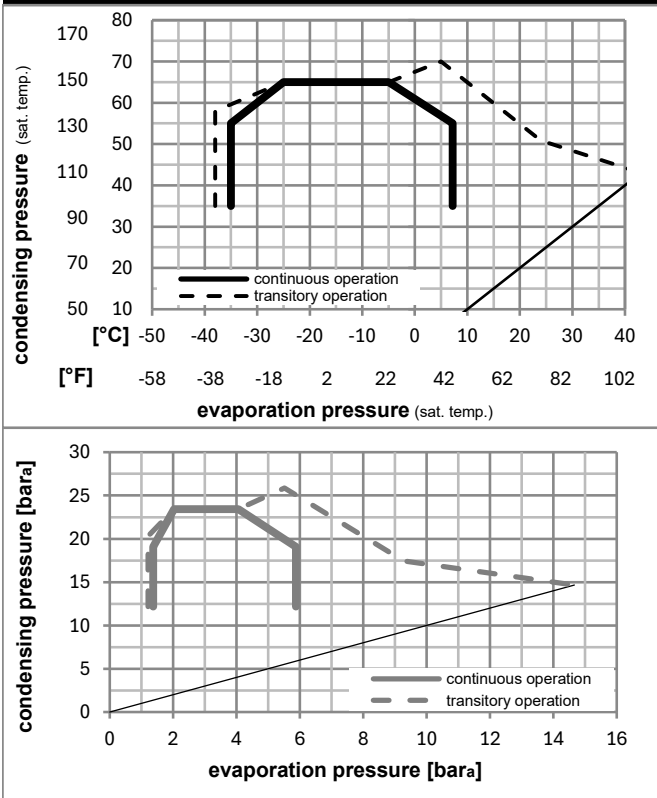

Components

a2	relay	117U7013
c	start capacitor (240µF, 6,3mm)	117U5073
b	plastic cover	103N2011
d	cord relief	103N1010

Model

Designation	NLE8.0CN	115V/60Hz	Conf. 1	Sales code:	105H6093
-------------	-----------------	------------------	----------------	-------------	-----------------

Optimization + standard conditions

R290, 115V/60Hz, CSIR, fan 3m/s, UL, CCC

	Evaporating pressure (saturation temperature)				Cooling capacity			COP	EER	P1	Power consumption		ASHRAE LBP	
	pe	pc	RGT	Tliq	[W]	[Btu/h]	[kcal/h]				I	m		
	[°C]	[°F]	[°C]	[°F]	[W]	[Btu/h]	[kcal/h]	[W/W]	[Btu/Wh]	[kcal/Wh]	[W]	[A]	[kg/h]	
	-23	54	32	32	452,8	1546	389,7	1,57	5,36	1,35	288,4	3,52	4,59	ASHRAE LBP
	-10	130	90	90										
	-25	55	32	55	339,0	1158	291,7	1,22	4,16	1,05	278,3	3,45	4,22	cecomaf LBP
	-13	131	90	131										
	-35	40	20	40	267,8	915	230,5	1,24	4,25	1,07	215,5	3,11	3,06	EN12900 LBP
	-31	104	68	104										
	-7	54	35	46	807,2	2757	694,7	2,07	7,08	1,78	389,5	4,26	9,21	ASHRAE MBP
	20	130	95	115										
	-10	55	32	55	639,9	2185	550,7	1,72	5,88	1,48	371,7	4,12	8,09	cecomaf MBP
	14	131	90	131										
	-10	45	20	45	718,2	2453	618,1	2,10	7,17	1,81	342,2	3,92	8,82	EN12900 MBP
	14	113	68	113										

Performance tables

R290, 115V/60Hz, CSIR, fan 3m/s, UL, CCC

	pe		Cooling capacity			COP	EER		P1	I	m
	[°C]	[°F]	[W]	[Btu/h]	[kcal/h]		[Btu/Wh]	[kcal/Wh]			
[°C / °F]	-35	-31	252,3	861	217,1	1,16	3,97	1,00	216,7	3,12	2,83
cond. pressure	-23	-10	437,5	1494	376,5	1,57	5,37	1,35	278,4	3,47	4,94
pc= 45/113	-15	5	615,8	2103	529,9	1,93	6,59	1,66	319,3	3,75	7,01
return gas temp.	-9	15	763,6	2608	657,2	2,22	7,57	1,91	344,6	3,94	8,74
RGT= 32/90	-4	25	939,5	3208	808,5	2,55	8,72	2,20	368,0	4,12	10,83
liquid temp	0	32	1081,3	3693	930,6	2,82	9,64	2,43	383,1	4,23	12,54
Tliq= 45/113	7,2	45	1391,2	4751	1197,3	3,41	11,65	2,94	407,8	4,41	16,35
[°C / °F]	-35	-31	196,1	670	168,7	0,92	3,14	0,79	213,2	3,07	2,42
cond. pressure	-23	-10	366,3	1251	315,2	1,27	4,33	1,09	289,0	3,52	4,57
pc= 55/131	-15	5	524,1	1790	451,0	1,54	5,24	1,32	341,4	3,89	6,59
return gas temp	-9	15	653,9	2233	562,7	1,74	5,95	1,50	375,0	4,15	8,28
RGT= 32/90	-4	25	808,0	2760	695,4	1,98	6,78	1,71	407,3	4,40	10,31
liquid temp	0	32	932,6	3185	802,6	2,17	7,43	1,87	428,8	4,57	11,98
Tliq= 55/131	7,2	45	1205,7	4118	1037,6	2,59	8,83	2,22	466,4	4,87	15,71

Model

Designation	NLE8.0CN	115V/60Hz	Conf. 2	Sales code:	105H6093
-------------	-----------------	------------------	----------------	-------------	-----------------

Configuration

Motorconfiguration	RSIR	
Power supply (nominal)	115V/60Hz 1~	
Refrigerant	R290	
Application	LBP+MBP	
Voltage range	95-135V	
Starting torque	LST	
Approvals	UL	SA3693
	CCC	

Electrical accessories / wiring diagram

RSIR

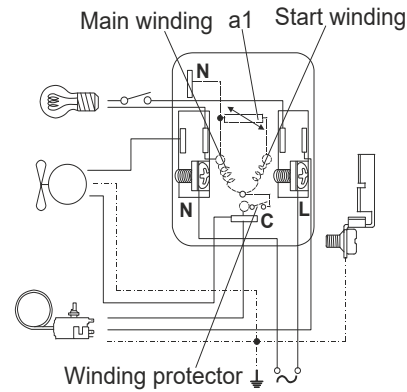
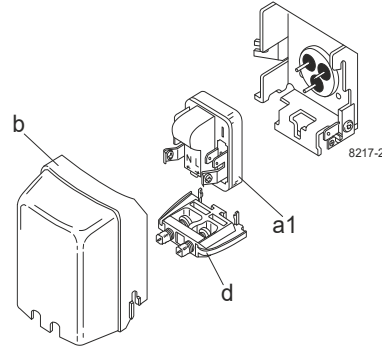

Ambient/ machine room temperatures minimum /maximum

Ambient temperature range:	10 - 43°C / 50 - 110°F
Machine room temperature range:	10 - 48°C / 50 - 119°F
Compressor cooling:	fan 3m/s

Operation pressure range

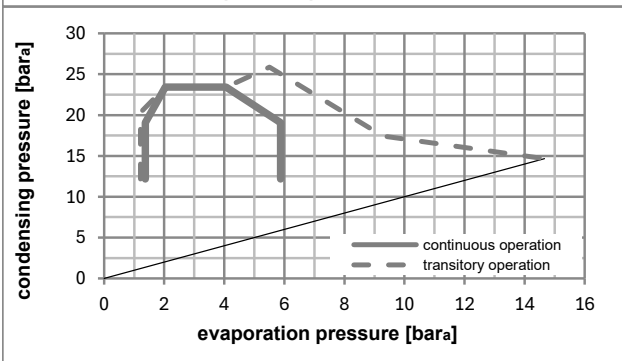
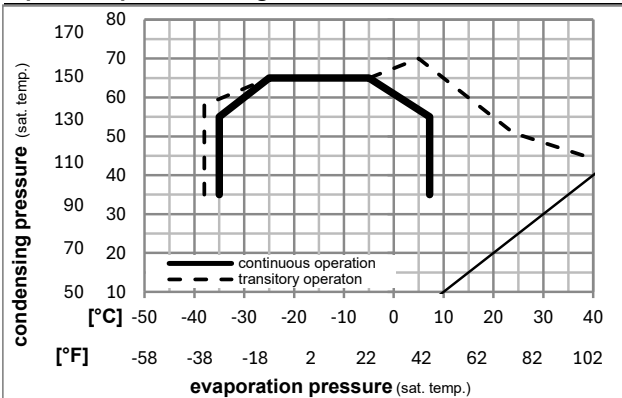

Components

a1	e-PTC starter (115V, 50hm, 6.3mm, 4.8-cap)	103N0057
b	plastic cover	103N2011
d	cord relief	103N1010

Alternative components

a1	e-PTC starter	103N0058
b	plastic cover	103N2011
d	cord relief	103N1010

Model

Designation	NLE8.0CN	115V/60Hz	Conf. 2	Sales code:	105H6093
-------------	-----------------	------------------	----------------	-------------	-----------------

Optimization + standard conditions

R290, 115V/60Hz, RSIR, fan 3m/s, UL, CCC

		Evaporating pressure (saturation temperature)				Cooling capacity			COP			EER			Power consumption			
		Condensing pressure (saturation temperature)		Return gas temp.		Liquid temp.					Current consumption			Ref. mass flow				
		pe	pc	RGT	Tliq	[W]	[Btu/h]	[kcal/h]	[W/W]	[Btu/Wh]	[kcal/Wh]	P1	I	m	[W]	[A]	[kg/h]	
[°C]	-23	54	32	32	452,8	1546	389,7	1,57	5,36	1,35	288,4	3,52	4,59	ASHRAE LBP				
[°F]	-10	130	90	90														
[°C]	-25	55	32	55	339,0	1158	291,7	1,22	4,16	1,05	278,3	3,45	4,22	cecomaf LBP				
[°F]	-13	131	90	131														
[°C]	-35	40	20	40	267,8	915	230,5	1,24	4,25	1,07	215,5	3,11	3,06	EN12900 LBP				
[°F]	-31	104	68	104														
[°C]	-7	54	35	46	807,2	2757	694,7	2,07	7,08	1,78	389,5	4,26	9,21	ASHRAE MBP				
[°F]	20	130	95	115														
[°C]	-10	55	32	55	639,9	2185	550,7	1,72	5,88	1,48	371,7	4,12	8,09	cecomaf MBP				
[°F]	14	131	90	131														
[°C]	-10	45	20	45	718,2	2453	618,1	2,10	7,17	1,81	342,2	3,92	8,82	EN12900 MBP				
[°F]	14	113	68	113														

Performance tables

R290, 115V/60Hz, RSIR, fan 3m/s, UL, CCC

	pe		Cooling capacity			COP			EER			P1			I			m			
	[°C]	[°F]	[W]	[Btu/h]	[kcal/h]	[W/W]	[Btu/Wh]	[kcal/Wh]	[W]	[A]	[kg/h]	[W]	[A]	[kg/h]	[W]	[A]	[kg/h]	[W]	[A]	[kg/h]	
[°C / °F]	-35	-31	252,3	861	217,1	1,16	3,97	1,00	216,7	3,12	2,83										
cond. pressure	-23	-10	437,5	1494	376,5	1,57	5,37	1,35	278,4	3,47	4,94										
pc= 45/113	-15	5	615,8	2103	529,9	1,93	6,59	1,66	319,3	3,75	7,01										
return gas temp.	-9	15	763,6	2608	657,2	2,22	7,57	1,91	344,6	3,94	8,74										
RGT= 32/90	-4	25	939,5	3208	808,5	2,55	8,72	2,20	368,0	4,12	10,83										
liquid temp	0	32	1081,3	3693	930,6	2,82	9,64	2,43	383,1	4,23	12,54										
Tliq= 45/113	7,2	45	1391,2	4751	1197,3	3,41	11,65	2,94	407,8	4,41	16,35										
[°C / °F]	-35	-31	196,1	670	168,7	0,92	3,14	0,79	213,2	3,07	2,42										
cond. pressure	-23	-10	366,3	1251	315,2	1,27	4,33	1,09	289,0	3,52	4,57										
pc= 55/131	-15	5	524,1	1790	451,0	1,54	5,24	1,32	341,4	3,89	6,59										
return gas temp	-9	15	653,9	2233	562,7	1,74	5,95	1,50	375,0	4,15	8,28										
RGT= 32/90	-4	25	808,0	2760	695,4	1,98	6,78	1,71	407,3	4,40	10,31										
liquid temp	0	32	932,6	3185	802,6	2,17	7,43	1,87	428,8	4,57	11,98										
Tliq= 55/131	7,2	45	1205,7	4118	1037,6	2,59	8,83	2,22	466,4	4,87	15,71										

Model

Designation	NLE8.0CN	115V/60Hz	Conf. 3	Sales code:	105H6093
-------------	-----------------	------------------	----------------	-------------	-----------------

Configuration

Motorconfiguration	RSCR	
Power supply (nominal)	115V/60Hz 1~	
Refrigerant	R290	
Application	LBP+MBP	
Voltage range	95-135V	
Starting torque	LST	
Approvals	UL	SA3693
	CCC	

Electrical accessories / wiring diagram

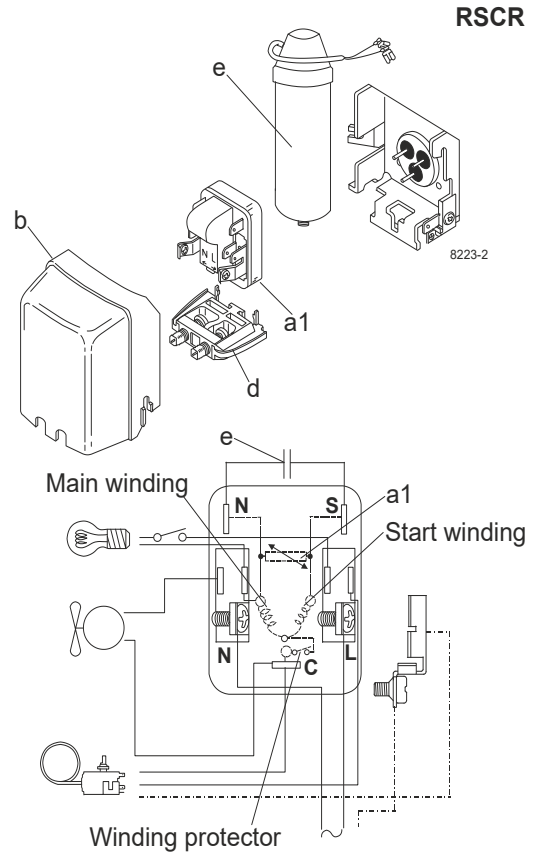

Ambient/ machine room temperatures minimum /maximum

Ambient temperature range:	10 - 43°C / 50 - 110°F
Machine room temperature range:	10 - 48°C / 50 - 119°F
Compressor cooling:	fan 3m/s

Operation pressure range

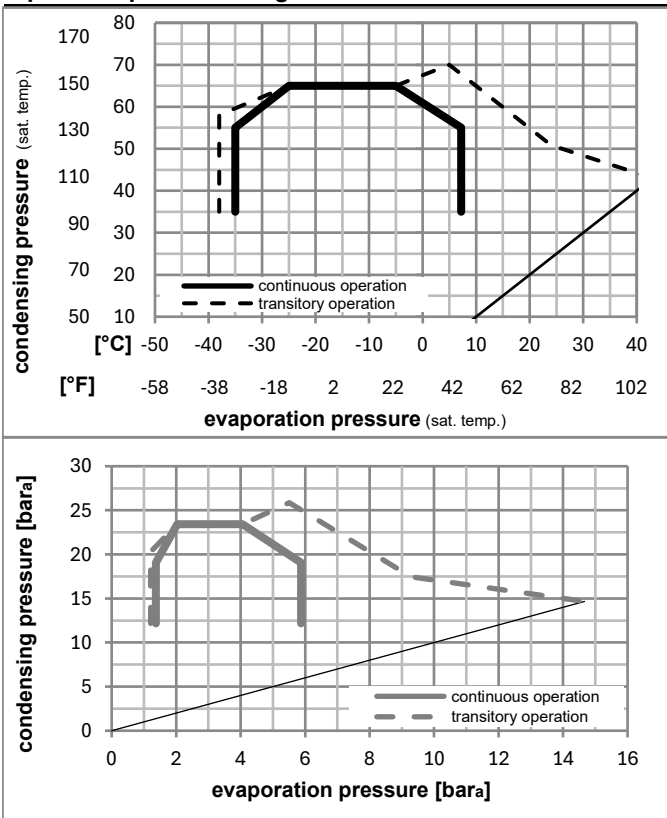

Components

a1	e-PTC starter	103N0058
e	run capacitor (20μF, 6.3mm)	117-7147
b	plastic cover	103N2011
d	cord relief	103N1010
	bracket for run capacitor	117-0300
	screw M4x8mm	117-0301

Alternative components

a1	e-PTC starter (115V, 50Ohm, 6.3mm, 4.8-cap)	103N0057
e	run capacitor (20μF, 4.8mm)	117-7146
b	plastic cover	103N2011
d	cord relief	103N1010
	bracket for run capacitor	117-0300
	screw M4x8mm	117-0301

Model

Designation	NLE8.0CN	115V/60Hz	Conf. 3	Sales code:	105H6093
-------------	-----------------	------------------	----------------	-------------	-----------------

Optimization + standard conditions

R290, 115V/60Hz, RSCR, fan 3m/s, UL, CCC

	Evaporating pressure (saturation temperature)				Cooling capacity			COP	EER	P1	Power consumption		Ref. mass flow	
	pe	pc	RGT	Tliq	[W]	[Btu/h]	[kcal/h]				[W]	[A]		
[°C]	-23	54	32	32	463,5	1583	398,9	1,70	5,81	1,46	272,5	3,32	4,69	ASHRAE LBP
[°F]	-10	130	90	90										
[°C]	-25	55	32	55	346,8	1184	298,5	1,32	4,50	1,13	263,2	3,26	4,32	cecomaf LBP
[°F]	-13	131	90	131										
[°C]	-35	40	20	40	272,2	929	234,2	1,32	4,52	1,14	205,5	2,97	3,11	EN12900 LBP
[°F]	-31	104	68	104										
[°C]	-7	54	35	46	823,4	2812	708,7	2,27	7,74	1,95	363,2	3,98	9,39	ASHRAE MBP
[°F]	20	130	95	115										
[°C]	-10	55	32	55	653,8	2233	562,6	1,88	6,42	1,62	347,8	3,86	8,27	cecomaf MBP
[°F]	14	131	90	131										
[°C]	-10	45	20	45	733,7	2506	631,4	2,29	7,83	1,97	320,1	3,67	9,01	EN12900 MBP
[°F]	14	113	68	113										

Performance tables

R290, 115V/60Hz, RSCR, fan 3m/s, UL, CCC

	pe		Cooling capacity			COP	EER	P1	I	m	
	[°C]	[°F]	[W]	[Btu/h]	[kcal/h]						[W/W]
[°C / °F]	-35	-31	256,4	876	220,7	1,24	4,24	1,07	206,6	2,97	2,87
cond. pressure	-23	-10	447,8	1529	385,4	1,70	5,82	1,47	263,0	3,27	5,06
pc= 45/113	-15	5	630,1	2152	542,3	2,10	7,18	1,81	299,9	3,52	7,17
return gas temp.	-9	15	780,0	2664	671,2	2,42	8,27	2,08	322,2	3,68	8,93
RGT= 32/90	-4	25	956,8	3268	823,4	2,80	9,55	2,41	342,3	3,83	11,03
liquid temp	0	32	1098,7	3752	945,5	3,10	10,58	2,67	354,7	3,92	12,74
Tliq= 45/113	7,2	45	1406,5	4803	1210,4	3,76	12,85	3,24	373,9	4,04	16,52
[°C / °F]	-35	-31	199,4	681	171,6	0,98	3,35	0,85	203,1	2,93	2,47
cond. pressure	-23	-10	374,9	1280	322,6	1,37	4,69	1,18	273,0	3,33	4,67
pc= 55/131	-15	5	536,4	1832	461,6	1,67	5,71	1,44	320,7	3,66	6,74
return gas temp	-9	15	667,9	2281	574,8	1,90	6,50	1,64	350,7	3,88	8,46
RGT= 32/90	-4	25	823,0	2811	708,3	2,17	7,42	1,87	378,8	4,09	10,50
liquid temp	0	32	947,5	3236	815,5	2,39	8,15	2,05	397,1	4,23	12,17
Tliq= 55/131	7,2	45	1218,6	4162	1048,8	2,85	9,73	2,45	427,8	4,46	15,88



NL Compressors





Service/Repair – R600a, R290

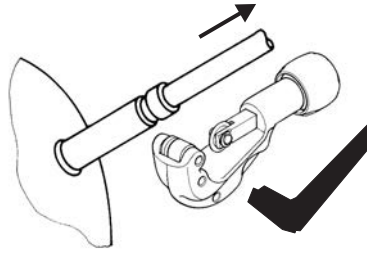
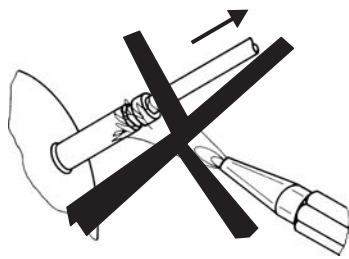

8545

Brazing on Suction Connectors (Direct Intake)

representative image



**! max. 150°C/302°F !
at socket**
brazing solder: phosphor (LP7) or silver

Refer to Product Bulletin:
**Brazing on Suction Connectors
(Compressors with Direct Suction Intake)**

Secop accepts no responsibility for possible errors in catalogs, brochures, and other printed material. Secop reserves the right to alter its products without notice. This also applies to products already on order provided that such alterations can be made without subsequential changes being necessary to specifications already agreed. All trademarks in this material are the property of the respective companies. Secop and the Secop logotype are trademarks of Secop GmbH. All rights reserved. www.secop.com