

## Single Pack SCE15CNX 220-240V 50Hz CSCR

Single pack code number: **195B4659**

Position	Title	Code	Amount
1	Compressor SCE15CNX	104H8540	1
2	Cord relief	103N1004	1
3	SC starting device (550mm)	117-7810	1
4	Bolt joint for one compressor   M6   ø16mm	118-1917	1

**Secop GmbH** • Lise-Meitner-Straße 29 • 24941 Flensburg, Germany • Tel: +49 461 4941 0 • [www.secop.com](http://www.secop.com)

Secop accepts no responsibility for possible errors in catalogs, brochures, and other printed material. Secop reserves the right to alter its products without notice. This also applies to products already on order provided that such alterations can be made without subsequent changes being necessary to specifications already agreed. All trademarks in this material are the property of the respective companies. Secop and the Secop logotype are trademarks of Secop GmbH. All rights reserved.

## Model

Designation	<b>SCE15CNX</b>	220-240V/50Hz 1~	Sales code:	<b>104H8540</b>
-------------	-----------------	------------------	-------------	-----------------

## Compressor design

Oil type	Polyolester	Refrigerant(s)	<b>R290</b>
Oil viscosity	32cSt	Displacement	15,28cm <sup>3</sup> / 0,93cu.in
Oil quantity	550cm <sup>3</sup> / 18,6fl.oz	Compressors on pallet	80
Refr. charge - tech. limit	550g / 19,4oz		
Free gas volume comp.	1460cm <sup>3</sup> / 49,4fl.oz		
Weight	14,2kg / 31,3lbs		
Motor protection	external		
Winding resistance main	4,62Ω (at 25°C)		
Winding resistance aux	15,94Ω (at 25°C)		
Max. winding temp.	125°C / 257°F		
Max. discharge temp.	140°C / 284°F		



## General - Configurations with SCE15CNX

	<b>Conf. 1</b>
Motorconfiguration	CSCR
Power supply (nominal)	220-240V/50Hz
Number of phases	1
Voltage range	198-254V
Approvals	VDE, CCC
Starting torque	HST
Note	Protector and cover are included and pre-assembled to compressor.

## Applications with SCE15CNX

	<b>Conf. 1</b>
Refrigerant	R290
Application	LBP+MBP
System cooling	fan 3m/s
Hot gas defrost	OK
Long interval pull down	OK

## Electrical data - Configurations with SCE15CNX

	<b>Conf. 1</b>
Starting device type	relay
Run capacitor	10μF
Start capacitor	80μF
LRA (locked rotor amps / 4s/ U(N))	16,51A
RLA (rated load amps / 1s/ U(N))	2,63A
Cut in current (U(N))	16,51A

## Model

Designation

**SCE15CNX**

220-240V/50Hz 1~

Sales code:

**104H8540**

## Compressor dimensions

Housing	A Height	219mm / 8,62in
	B Height	213mm / 8,39in
	C Length shell	218mm / 8,58in
	D Length w. cover	255mm / 10,04in
	E Width	151mm / 5,94in

Connectors	Suction		Discharge		Process	
	X		Y		Z	
Diameter [mm]	øi 10,11-10,29		øi 6,11-6,29		øi 6,11-6,29	
(i:inside, o:outside) [in]	øi 0,4-0,41		øi 0,24-0,25		øi 0,24-0,25	
Material	copper		copper		copper	
Horizontal angle ±2°	37°		37°		143°	
Vertical angle ±2°	30°		0°		150°	
Position l/h/w [mm]	107/193/55		115/110/63		-107/193/55	
	[in] 4,2/7,6/2,2		4,5/4,3/2,5		-4,2/7,6/2,2	
Straight tube l. [mm]	12		12		12	
	[in] 0,5		0,5		0,5	



## Compressor fixation

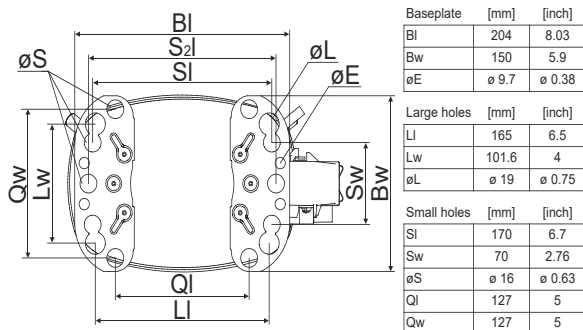

## Bolt joint



## Snap-on

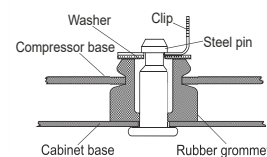

## Mounting accessories

	one comp.	multi pack
Bolt joint   M6   ø16mm	118-1917	118-1918
Bolt joint   ø1/4"   ø16mm	118-1946	
Bolt joint   ø1/4"   ø19mm	118-1949	
Snap-on   ø7,3   ø16mm	118-1947	118-1919

## Application notes

Provision for PE Grounding is located at the PE Stamp on the compressor

## Model

Designation	<b>SCE15CNX</b>	<b>220-240V/50Hz</b>	<b>Conf. 1</b>	Sales code:	<b>104H8540</b>
-------------	-----------------	----------------------	----------------	-------------	-----------------

## Configuration

Motor configuration	CSCR
Power supply (nominal)	220-240V/50Hz 1~
Refrigerant	R290
Application	LBP+MBP
Voltage range	198-254V
Starting torque	HST
Approvals	VDE CCC

## Electrical accessories / wiring diagram

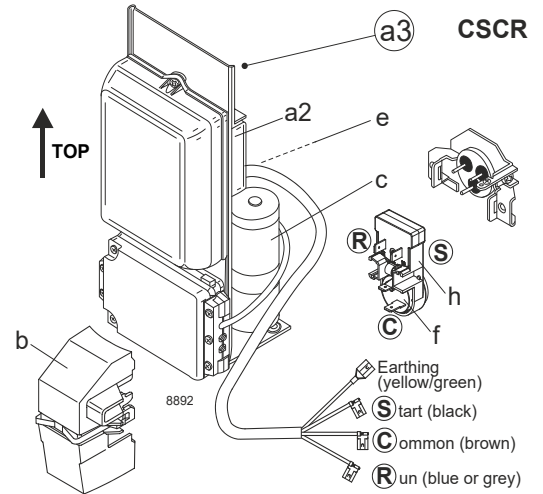

## Ambient/ machine room temperatures minimum /maximum

Ambient temperature range:	10 - 43°C / 50 - 110°F
Machine room temperature range:	10 - 48°C / 50 - 119°F
Compressor cooling:	fan 3m/s

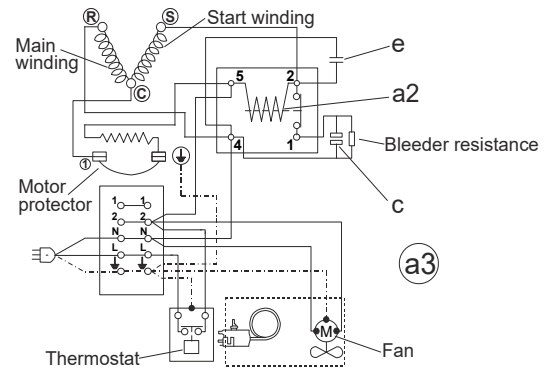

## Operation pressure range

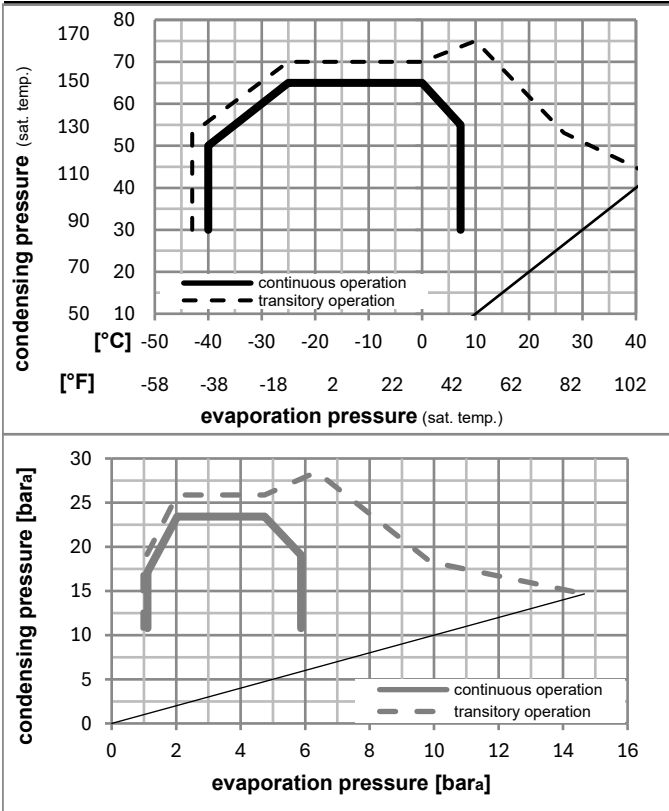

## Components (protector (f)+ holder (h)+ cover (b): pre assembled)

a3	SC starter kit (550mm)	117-7810
f / h	protector assy. (T1132)	117U8004
d	cord relief	103N1004
b	plastic cover + clamp	117U1033

## Alternative comp.

a2	potential relay (RVA 4L3R 447)	117-7429
e	run capacitor (10μF, 6.3mm)	117-7112
c	start capacitor (80μF)	117U5373

## Noise emission

Operation pressures:	pe: -25°C / -13°F
	pc: 45°C / 113°F
Motor speed appr.:	2900rpm
Lw(A):	56dB(A)

## Model

Designation **SCE15CNX** **220-240V/50Hz** Conf. 1 Sales code: **104H8540**

## Optimization + standard conditions

R290, 230V/50Hz, CSCR, fan 3m/s, VDE, CCC

	Evaporating pressure (saturation temperature)				Condensing pressure (saturation temperature)			Return gas temp.	Liquid temp.	Cooling capacity	COP	EER	Power consumption			Ref. mass flow
	pe	pc	RGT	Tliq	[W]	[Btu/h]	[kcal/h]						P1	I	m	
	[°C]	[°F]	[°C]	[°F]	[W]	[Btu/h]	[kcal/h]	[W/W]	[Btu/Wh]	[kcal/Wh]	[W]	[A]	[kg/h]			
ASHRAE LBP	-23	54	32	32	662,5	2263	570,2	1,62	5,52	1,39	409,8	1,92	6,71			
	-10	130	90	90												
cecomaf LBP	-25	55	32	55	488,2	1667	420,1	1,24	4,24	1,07	393,4	1,84	6,08			
	-13	131	90	131												
EN12900 LBP	-35	40	20	40	355,6	1214	306,0	1,20	4,10	1,03	296,2	1,39	4,06			
	-31	104	68	104												
ASHRAE MBP	-7	54	35	46	1278,4	4366	1100,2	2,23	7,63	1,92	572,5	2,65	14,58			
	20	130	95	115												
cecomaf MBP	-10	55	32	55	1006,3	3437	866,0	1,85	6,31	1,59	544,3	2,52	12,73			
	14	131	90	131												
EN12900 MBP	-10	45	20	45	1130,0	3859	972,5	2,26	7,70	1,94	501,0	2,29	13,87			
	14	113	68	113												

## Performance tables

R290, 230V/50Hz, CSCR, fan 3m/s, VDE, CCC

	pe		Cooling capacity			COP	EER	P1	I	m	
	[°C]	[°F]	[W]	[Btu/h]	[kcal/h]	[W/W]	[Btu/Wh]	[kcal/Wh]	[W]	[A]	[kg/h]
[°C / °F]	-40	-40	241,3	824	207,7	0,92	3,15	0,79	261,5	1,25	2,70
cond. pressure	-35	-31	332,5	1135	286,1	1,11	3,80	0,96	298,9	1,41	3,73
pc= 45/113	-25	-13	589,0	2012	506,9	1,54	5,28	1,33	381,3	1,77	6,64
return gas temp.	-15	5	952,1	3252	819,4	2,05	7,01	1,77	463,7	2,13	10,83
RGT= 32/90	-5	23	1430,8	4886	1231,4	2,68	9,16	2,31	533,7	2,43	16,47
liquid temp	0	32	1716,4	5862	1477,2	3,06	10,46	2,64	560,2	2,54	19,91
Tliq= 45/113	7,2	45	2184,9	7462	1880,3	3,74	12,77	3,22	584,3	2,65	25,67
[°C / °F]	-40	-40	171,0	584	147,1	0,68	2,31	0,58	253,2	1,15	2,11
cond. pressure	-35	-31	256,3	875	220,6	0,87	2,96	0,74	296,1	1,37	3,17
pc= 55/131	-25	-13	488,2	1667	420,1	1,24	4,24	1,07	393,4	1,84	6,08
return gas temp	-15	5	809,4	2764	696,5	1,63	5,58	1,41	495,4	2,30	10,18
RGT= 32/90	-5	23	1229,0	4197	1057,7	2,08	7,12	1,79	589,8	2,72	15,66
liquid temp	0	32	1478,6	5050	1272,5	2,35	8,01	2,02	630,2	2,90	18,99
Tliq= 55/131	7,2	45	1887,7	6447	1624,6	2,79	9,53	2,40	676,6	3,10	24,59

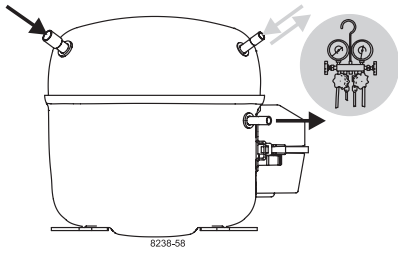

# SCE Compressors

## (External Protector)

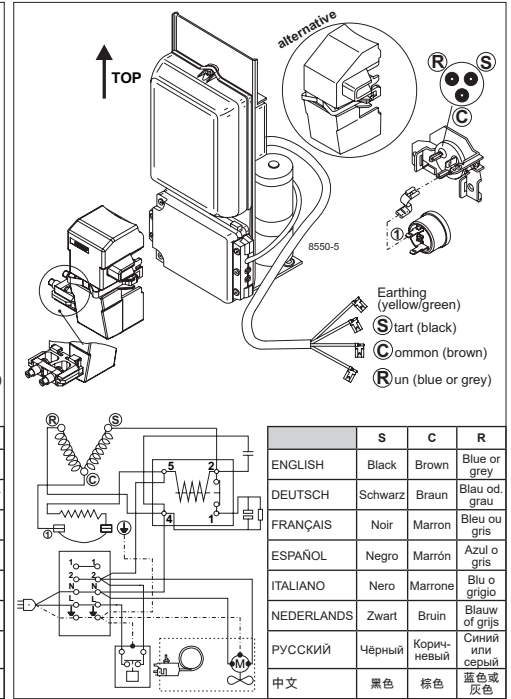
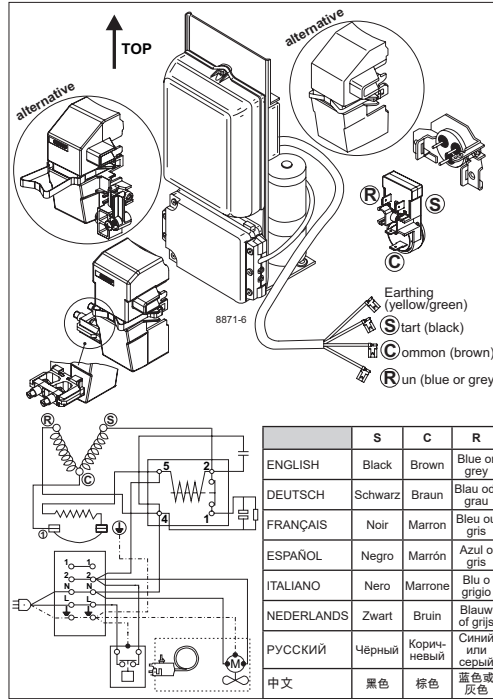

	S	C	R
ENGLISH	Black	Brown	Blue or grey
DEUTSCH	Schwarz	Braun	Blau od. grau
FRANÇAIS	Noir	Marron	Bleu ou gris
ESPAÑOL	Negro	Marrón	Azul o gris
ITALIANO	Nero	Marrone	Blu o grigio
NEDERLANDS	Zwart	Bruin	Blauw of grijs
РУССКИЙ	Чёрный	Коричневый	Синий или серый
中文	黑色	棕色	蓝色或灰色

	S	C	R
ENGLISH	Black	Brown	Blue or grey
DEUTSCH	Schwarz	Braun	Blau od. grau
FRANÇAIS	Noir	Marron	Bleu ou gris
ESPAÑOL	Negro	Marrón	Azul o gris
ITALIANO	Nero	Marrone	Blu o grigio
NEDERLANDS	Zwart	Bruin	Blauw of grijs
РУССКИЙ	Чёрный	Коричневый	Синий или серый
中文	黑色	棕色	蓝色或灰色



# SCE Compressors (External Protector)



## Service/Repair – R290

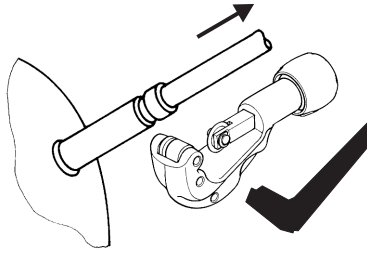

8545

## Brazing on Suction Connectors (Direct Intake)



**! max. 350°C/662°F !  
at socket**  
brazing solder: phosphor (LP7) or silver

8882

Refer to Product Bulletin:  
**Brazing on Suction Connectors**  
(SCE Compressors with Direct Suction Intake)

Secop accepts no responsibility for possible errors in catalogs, brochures, and other printed material. Secop reserves the right to alter its products without notice. This also applies to products already on order provided that such alterations can be made without subsequential changes being necessary to specifications already agreed. All trademarks in this material are the property of the respective companies. Secop and the Secop logotype are trademarks of Secop GmbH. All rights reserved. [www.secop.com](http://www.secop.com)