

## Single Pack SC15CL 220-240V 50Hz CSIR

Single pack code number: **195B4021**

Position	Title	Code	Amount
1	Compressor SC15CL	104L2853	1
2	Starting relay	117U6019	1
3	Starting capacitor (80 $\mu$ F 220V, 6.3mm)	117U5017	1
4	Cord relief	103N1004	1
5	Cover	103N2009	1
6	Bolt joint for one compressor   M6   $\varnothing$ 16mm	118-1917	1

Secop GmbH • Lise-Meitner-Straße 29 • 24941 Flensburg, Germany • Tel: +49 461 4941 0 • [www.secop.com](http://www.secop.com)

Secop accepts no responsibility for possible errors in catalogs, brochures, and other printed material. Secop reserves the right to alter its products without notice. This also applies to products already on order provided that such alterations can be made without subsequent changes being necessary to specifications already agreed. All trademarks in this material are the property of the respective companies. Secop and the Secop logotype are trademarks of Secop GmbH. All rights reserved.

## Model

Designation	<b>SC15CL</b>	220-240V/50Hz 1~	Sales code:	<b>104L2853</b>
-------------	---------------	------------------	-------------	-----------------

## Compressor design

Oil type	Polyolester	Refrigerant(s)	<b>R404A, R452A, R507</b>
Oil viscosity	32cST	Displacement	15,28cm <sup>3</sup> / 0,93cu.in
Oil quantity	506cm <sup>3</sup> / 17,1fl.oz	Compressors on pallet	80
Refr. charge - tech. limit	1300g / 45,9oz		
Free gas volume comp.	1510cm <sup>3</sup> / 51,1fl.oz		
Weight	13,8kg / 30,4lbs		
Motor protection	1# internal		
Winding resistance main	3,7Ω (at 25°C)		
Winding resistance aux	14Ω (at 25°C)		
Max. winding temp.	125°C / 257°F		
Max. discharge temp.	130°C / 266°F		



## General - Configurations with SC15CL

	<b>Conf. 1</b>	<b>Conf. 2</b>
Motorconfiguration	CSIR	CSIR
Power supply (nominal)	220-240V/50Hz	220-240V/50Hz
Number of phases	1	1
Voltage range	198-254V	198-254V
Approvals	VDE, CCC, EAC	VDE, CCC
Starting torque	HST	HST
Note	- / -	

## Applications with SC15CL

	<b>Conf. 1</b>	<b>Conf. 2</b>
Refrigerant	R404A	R452A
Application	LBP+MBP	LBP+MBP
System cooling	fan 3m/s	fan 3m/s
Hot gas defrost	OK	OK
Long interval pull down	OK	OK

## Electrical data - Configurations with SC15CL

	<b>Conf. 1</b>	<b>Conf. 2</b>
Starting device type	relay	relay
Run capacitor	- / -	- / -
Start capacitor	80μF	80μF
LRA (locked rotor amps / 4s)	20,43A	20,43A
RLA (rated load amps / 1s)	3,9A	3,9A
Cut in current	20,43A	20,43A

## Model

Designation

**SC15CL**

220-240V/50Hz 1~

Sales code:

**104L2853**

## Compressor dimensions

Housing	A Height	219mm / 8,62in
	B Height	213mm / 8,39in
	C Length shell	218mm / 8,58in
	D Length w. cover	255mm / 10,04in
	E Width	151mm / 5,94in

Connectors	Suction X	Discharge Y	Process Z
Diameter [mm]	øi 10,11-10,29	øi 6,11-6,29	øi 6,11-6,29
(i:inside, o:outside) [in]	øi 0,4-0,41	øi 0,24-0,25	øi 0,24-0,25
Material	copper	copper	copper
Horizontal angle ±2°	37°	37°	143°
Vertical angle ±2°	30°	0°	150°
Position l/h/w [mm]	107/193/55	115/110/63	-107/193/55
[in]	4,2/7,6/2,2	4,5/4,3/2,5	-4,2/7,6/2,2
Straight tube l. [mm]	12	12	12
[in]	0,5	0,5	0,5



## Compressor fixation



## Bolt joint



## Snap-on

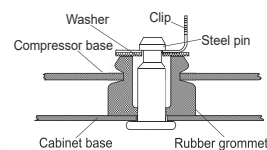

## Mounting accessories

Mounting accessories	one comp.	multi pack
Bolt joint   M6   ø16mm	118-1917	118-1918
Bolt joint   ø1/4"   ø16mm	118-1946	
Bolt joint   ø1/4"   ø19mm	118-1949	
Snap-on   ø7,3   ø16mm	118-1947	118-1919

## Application notes

Provision for PE Grounding is located at the PE Stamp on the compressor

## Model

Designation	<b>SC15CL</b>	<b>220-240V/50Hz</b>	<b>Conf. 1</b>	Sales code:	<b>104L2853</b>
-------------	---------------	----------------------	----------------	-------------	-----------------

## Configuration

Motorconfiguration	CSIR
Power supply (nominal)	220-240V/50Hz 1~
Refrigerant	R404A
Application	LBP+MBP
Voltage range	198-254V
Starting torque	HST
Approvals	VDE CCC EAC

## Electrical accessories / wiring diagram

CSIR

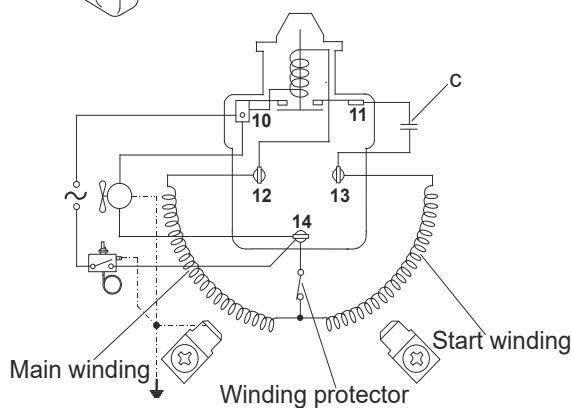
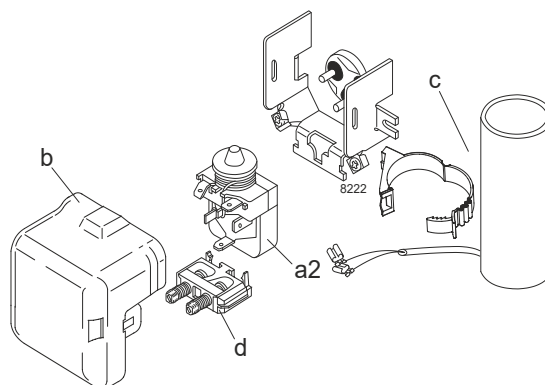

## Ambient/ machine room temperatures minimum /maximum

Ambient temperature range:	10 - 38°C / 50 - 101°F
Machine room temperature range:	10 - 43°C / 50 - 110°F
Compressor cooling:	fan 3m/s

## Operation Limits

### Operation pressure range

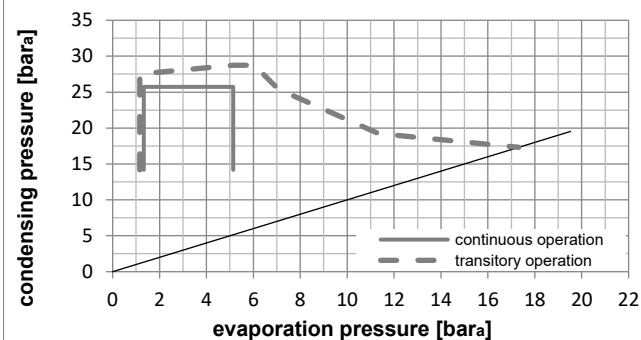
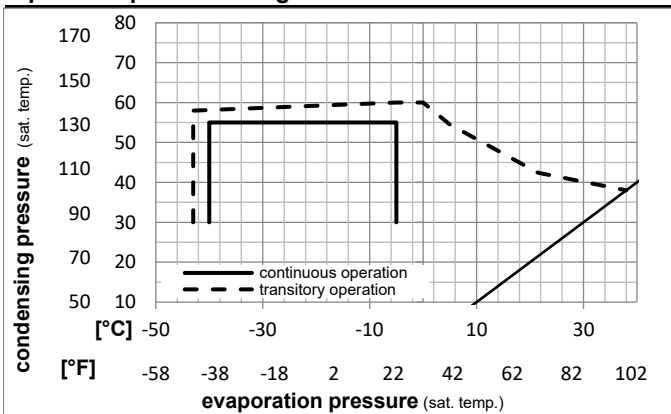

### Components

a2	relay	117U6019
c	start capacitor (80μF)	117U5017
d	cord relief	103N1004
b	plastic cover	103N2009

## Model

Designation **SC15CL** **220-240V/50Hz** Conf. 1 Sales code: **104L2853**

## Optimization + standard conditions

R404A, 220V/50Hz, CSIR, fan 3m/s, VDE, CCC, EAC

		Evaporating pressure (saturation temperature)				Condensing pressure (saturation temperature)			Return gas temp.		Liquid temp.		Cooling capacity			COP	EER	Power consumption		
		pe	pc	RGT	Tliq	[W]	[Btu/h]	[kcal/h]	[W/W]	[Btu/Wh]	[kcal/Wh]	P1	I	Current consumption		Ref. mass flow				
[°C]	[°F]	[°C]	[°F]	[°C]	[°F]							[W]	[A]	[kg/h]	ASHRAE LBP					
-23	-10	54	130	32	90	695,3	2375	598,4	1,19	4,08	1,03	582,2	3,55	16,20						
-25	-13	55	131	32	90	455,8	1557	392,2	0,84	2,85	0,72	545,6	3,44	14,24	cecomaf LBP					
-35	-31	40	104	20	68	354,2	1210	304,8	0,86	2,93	0,74	413,0	3,05	9,62	EN12900 LBP					
-7	20	54	130	35	95	1351,3	4615	1163,0	1,50	5,12	1,29	902,2	4,63	37,18	ASHRAE MBP					
-10	14	55	131	32	90	1014,9	3466	873,4	1,22	4,15	1,05	834,9	4,40	32,49	cecomaf MBP					
-10	14	45	113	20	68	1138,7	3889	980,0	1,44	4,92	1,24	790,0	4,31	34,30	EN12900 MBP					

## Performance tables

R404A, 220V/50Hz, CSIR, fan 3m/s, VDE, CCC, EAC

	pe		Cooling capacity			COP	EER	P1	I	m	
	[°C]	[°F]	[W]	[Btu/h]	[kcal/h]	[W/W]	[Btu/Wh]	[kcal/Wh]	[W]	[A]	[kg/h]
[°C / °F]	-40	-40	151,1	516	130,1	0,51	1,73	0,44	298,4	2,83	4,03
cond. pressure	-35	-31	299,5	1023	257,7	0,75	2,56	0,64	400,3	3,05	8,01
pc= 45/113	-30	-22	452,5	1545	389,4	0,93	3,18	0,80	485,2	3,28	12,15
return gas temp.	-25	-13	615,0	2100	529,3	1,10	3,75	0,95	560,0	3,52	16,59
RGT= 32/90	-20	-4	791,9	2705	681,5	1,25	4,28	1,08	631,2	3,77	21,49
liquid temp	-15	5	988,1	3375	850,4	1,40	4,78	1,21	705,7	4,04	26,99
Tliq= 45/113	-5	23	1457,8	4979	1254,6	1,64	5,59	1,41	891,0	4,60	40,53
[°C / °F]	-40	-40	-44,2	-151	-38,0	-0,29	-1,00	-0,25	151,5	2,58	-1,36
cond. pressure	-35	-31	124,0	424	106,7	0,41	1,39	0,35	305,7	2,85	3,84
pc= 55/131	-30	-22	289,1	987	248,8	0,66	2,27	0,57	434,8	3,14	8,98
return gas temp	-25	-13	455,8	1557	392,2	0,84	2,85	0,72	545,6	3,44	14,24
RGT= 32/90	-20	-4	629,1	2148	541,4	0,98	3,33	0,84	644,7	3,75	19,79
liquid temp	-15	5	813,8	2779	700,4	1,10	3,76	0,95	738,9	4,07	25,81
Tliq= 55/131	-5	23	1237,2	4225	1064,7	1,32	4,50	1,13	939,4	4,74	40,04

## Model

Designation	<b>SC15CL</b>	<b>220-240V/50Hz</b>	<b>Conf. 2</b>	Sales code:	<b>104L2853</b>
-------------	---------------	----------------------	----------------	-------------	-----------------

## Configuration

Motorconfiguration	CSIR
Power supply (nominal)	220-240V/50Hz 1~
Refrigerant	R452A
Application	LBP+MBP
Voltage range	198-254V
Starting torque	HST
Approvals	VDE CCC

## Electrical accessories / wiring diagram

CSIR



## Ambient/ machine room temperatures minimum /maximum

Ambient temperature range:	10 - 38°C / 50 - 101°F
Machine room temperature range:	10 - 43°C / 50 - 110°F
Compressor cooling:	fan 3m/s

## Operation Limits

## Operation pressure range

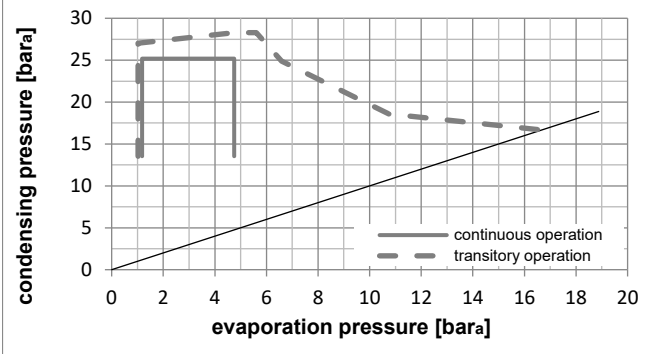
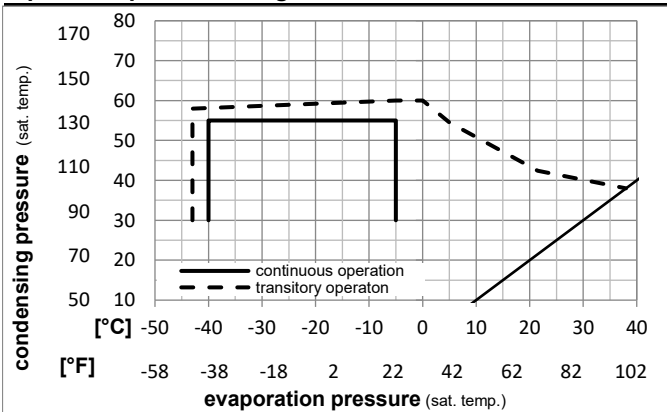

## Components

a2	relay	117U6019
c	start capacitor (80μF)	117U5017
d	cord relief	103N1004
b	plastic cover	103N2009

## Model

Designation **SC15CL** **220-240V/50Hz** Conf. 2 Sales code: **104L2853**

## Optimization + standard conditions

R452A, 220V/50Hz, CSIR, fan 3m/s, VDE, CCC

		Evaporating pressure (saturation temperature)				Condensing pressure (saturation temperature)						Power consumption			
		Return gas temp.		Liquid temp.		Cooling capacity		COP	EER		P1	I	Ref. mass flow		
		pe	pc	RGT	Tliq	[W]	[Btu/h]	[kcal/h]	[W/W]	[Btu/Wh]	[kcal/Wh]	[W]	[A]	[kg/h]	
[°C]	[°F]	[°C]	[°F]	[°C]	[°F]										
-23	54	32	32	635,6	2171	547,0	1,17	4,00	1,01	542,1	3,35	15,28	ASHRAE LBP		
-10	130	90	90												
-25	55	32	55	420,2	1435	361,6	0,83	2,83	0,71	506,8	3,23	13,37	cecomaf LBP		
-13	131	90	131												
-35	40	20	40	319,3	1090	274,8	0,84	2,87	0,72	380,1	2,86	8,92	EN12900 LBP		
-31	104	68	104												
-7	54	35	46	1278,2	4365	1100,0	1,49	5,09	1,28	857,4	4,54	35,96	ASHRAE MBP		
20	130	95	115												
-10	55	32	55	961,3	3283	827,3	1,22	4,15	1,05	790,5	4,26	31,24	cecomaf MBP		
14	131	90	131												
-10	45	20	45	1075,0	3671	925,1	1,44	4,90	1,24	748,9	4,08	33,03	EN12900 MBP		
14	113	68	113												

## Performance tables

R452A, 220V/50Hz, CSIR, fan 3m/s, VDE, CCC

	pe		Cooling capacity			COP	EER	P1			I	m
	[°C]	[°F]	[W]	[Btu/h]	[kcal/h]	[W/W]	[Btu/Wh]	[kcal/Wh]	[W]	[A]	[kg/h]	
[°C / °F]	-40	-40	132,3	452	113,9	0,49	1,66	0,42	272,2	2,65	3,62	
cond. pressure	-35	-31	269,3	920	231,8	0,73	2,50	0,63	367,7	2,84	7,39	
pc= 45/113	-30	-22	412,3	1408	354,8	0,92	3,14	0,79	448,7	3,03	11,36	
return gas temp.	-25	-13	566,1	1933	487,2	1,09	3,71	0,93	521,1	3,23	15,66	
RGT= 32/90	-20	-4	735,3	2511	632,8	1,24	4,25	1,07	591,2	3,46	20,45	
liquid temp	-15	5	924,8	3158	795,9	1,39	4,75	1,20	665,1	3,74	25,87	
Tliq= 45/113	-5	23	1383,1	4724	1190,3	1,63	5,57	1,40	848,6	4,50	39,30	
[°C / °F]	-40	-40	-44,6	-152	-38,4	-0,33	-1,12	-0,28	135,6	2,27	-1,40	
cond. pressure	-35	-31	109,7	375	94,4	0,39	1,34	0,34	279,2	2,61	3,46	
pc= 55/131	-30	-22	263,1	898	226,4	0,66	2,24	0,56	400,9	2,93	8,33	
return gas temp	-25	-13	420,2	1435	361,6	0,83	2,83	0,71	506,8	3,23	13,37	
RGT= 32/90	-20	-4	585,8	2001	504,1	0,97	3,32	0,84	602,9	3,55	18,75	
liquid temp	-15	5	764,6	2611	658,0	1,10	3,75	0,95	695,5	3,88	24,65	
Tliq= 55/131	-5	23	1180,6	4032	1016,1	1,32	4,51	1,14	894,2	4,69	38,75	

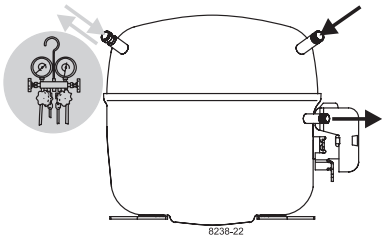

# SC Compressors







# SC Compressors

## Service/Repair – R290



8545



Secop accepts no responsibility for possible errors in catalogs, brochures, and other printed material. Secop reserves the right to alter its products without notice. This also applies to products already on order provided that such alterations can be made without subsequent changes being necessary to specifications already agreed. All trademarks in this material are the property of the respective companies. Secop and the Secop logotype are trademarks of Secop GmbH. All rights reserved. [www.secop.com](http://www.secop.com)