

Single Pack BD50F 12/24V DC, 100-240V AC 50/60Hz PM

Single pack code number: **195B4327**

Position	Title	Code	Amount
1	Compressor BD50F	101Z1220	1
2	Electronic unit 12/24V DC, 100-240V AC 50/60Hz	101N0510	1
3	Bolt joint for one compressor M6 ø16mm	118-1917	1

Secop GmbH • Lise-Meitner-Straße 29 • 24941 Flensburg, Germany • Tel: +49 461 4941 0 • www.secop.com

Secop accepts no responsibility for possible errors in catalogs, brochures, and other printed material. Secop reserves the right to alter its products without notice. This also applies to products already on order provided that such alterations can be made without subsequent changes being necessary to specifications already agreed. All trademarks in this material are the property of the respective companies. Secop and the Secop logotype are trademarks of Secop GmbH. All rights reserved.

BD50F Direct Current Compressor R134a, R1234yf, 12/24V DC & 100-240V AC 50/60Hz



General

Code number (without electronic units)	101Z1220
Electronic unit 12/24V DC - Standard	101N0242, 30 pcs: 101N0243
Electronic unit 12/24V DC - AEO	101N0340, 30 pcs: 101N0341
Electronic unit 12/24V DC & 100-240V AC 50/60Hz	101N0510, 28 pcs: 101N0511
Electronic unit 12/24V DC - Automotive	101N0680, 30 pcs: 101N0681
Compressors on pallet	150

Approvals

R134a	R134a/R1234yf
-	-
VDE	UL / CB
VDE	UL / CB
-	UL / CB



Application

Application	LBP/MBP/HBP
Evaporating temperature °C	-30 to 0 (10)
Voltage range DC VDC	9.6 - 17 / 21.3 - 31.5
Voltage range AC V/Hz	100 - 240 / 50 - 60
Max. condensing temperature continuous (short) °C	60 (70)
Max. winding temperature continuous (short) °C	125 (135)



Blue stripe
Barcode on white background
Grey background
Country of origin or manufacturer

Cooling requirements

Application	LBP	MBP	HBP
32°C	S	S	F ₁
38°C	S	S	F ₁
43°C	S	S	F ₁

Remarks on application: Fan cooling F₁ depending on application and speed.

- S = Static cooling normally sufficient
- O = Oil cooling
- F₁ = Fan cooling 1.5 m/s
(compressor compartment temperature equal to ambient temperature)
- F₂ = Fan cooling 3.0 m/s necessary
- SG = Suction gas cooling normally sufficient
- = not applicable in this area

Motor

Motor type	variable speed
Resistance, all 3 windings (25°C) Ω	1.8

Design

Displacement cm ³	2.50
Oil quantity (type) cm ³	150 (polyolester)
Maximum refrigerant charge g	300
Free gas volume in compressor cm ³	870
Weight - Compressor/Electronic unit kg	4.3 / 0.19 (Standard)

Standard battery protection settings (refer to electronic unit Instructions for optional settings)

Voltage	12V	24V
Cut out VDC	10.4	22.8
Cut in VDC	11.7	24.2

Dimensions

Height mm	A	137
	B	135
	B1	128
	B2	73
Suction connector location/I.D. mm angle	C	6.2 40°
	material comment	Cu-plated steel Al cap
Process connector location/I.D. mm angle	D	6.2 45°
	material comment	Cu-plated steel Al cap
Discharge connector location/I.D. mm angle	E	5.0 21°
	material comment	Cu-plated steel Al cap
Connector tolerance I.D. mm		±0.09, on 5.0 +0.12/+0.20

Remarks:

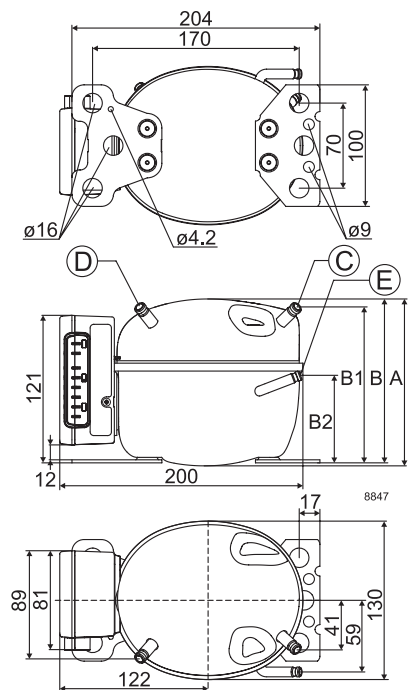

Performance Data with Refrigerant R134a

Capacity (EN 12900 Household/CECOMAF)												
12V DC, static cooling											watt	
rpm \ °C	-30	-25	-23.3	-20	-15	-10	-5	0	5	7.2	10	15
2,000	20.9	30.1	33.8	41.8	56.1	72.8	92.1	114	138*	150*	165*	
2,500	26.1	37.0	41.4	50.9	68.0	88.7	113	142*	175*	191*		
3,000	31.2	44.8	50.2	61.8	82.4	107	136*	169*				
3,500	37.0	52.0	58.0	71.1	94.7	123*	157*					

Capacity (ASHRAE LBP)												
12V DC, static cooling											watt	
rpm \ °C	-30	-25	-23.3	-20	-15	-10	-5	0	5	7.2	10	15
2,000	25.9	37.2	41.8	51.7	69.3	90.0	114	141	171*	185*	205*	
2,500	32.3	45.9	51.3	63.1	84.3	110	140	176*	217*	237*		
3,000	38.5	55.4	62.0	76.4	102	132	168*	210*				
3,500	45.5	64.2	71.6	87.8	117	152*	194*					

Power consumption												
12V DC, static cooling											watt	
rpm \ °C	-30	-25	-23.3	-20	-15	-10	-5	0	5	7.2	10	15
2,000	25.0	31.6	33.8	38.0	44.3	50.8	57.7	65.3	73.8*	77.9*	83.5*	
2,500	30.7	39.5	42.4	48.0	56.5	64.9	73.4	82.0*	90.9*	94.9*		
3,000	37.4	48.1	51.6	58.3	68.3	78.1	87.9*	98.0*				
3,500	45.0	56.8	60.7	68.2	79.5	91.2*	104*					

Current consumption (for 24V applications the following must be halved)												
12V DC, static cooling											A	
rpm \ °C	-30	-25	-23.3	-20	-15	-10	-5	0	5	7.2	10	15
2,000	2.1	2.6	2.8	3.1	3.7	4.3	4.9	5.6	6.3*	6.6*	7.1*	
2,500	2.6	3.2	3.5	3.9	4.6	5.4	6.1	6.9*	7.6*	8.0*		
3,000	3.2	4.0	4.3	4.8	5.6	6.5	7.3*	8.2*				
3,500	3.9	4.7	5.0	5.6	6.6	7.6*	8.7*					

COP (EN 12900 Household/CECOMAF)												
12V DC, static cooling											W/W	
rpm \ °C	-30	-25	-23.3	-20	-15	-10	-5	0	5	7.2	10	15
2,000	0.84	0.95	1.00	1.10	1.27	1.43	1.60	1.74	1.87*	1.92*	1.97*	
2,500	0.85	0.94	0.98	1.06	1.20	1.37	1.54	1.73*	1.92*	2.01*		
3,000	0.83	0.93	0.97	1.06	1.21	1.37	1.54*	1.72*				
3,500	0.82	0.92	0.96	1.04	1.19	1.35*	1.51*					

COP (ASHRAE LBP)												
12V DC, static cooling											W/W	
rpm \ °C	-30	-25	-23.3	-20	-15	-10	-5	0	5	7.2	10	15
2,000	1.04	1.19	1.25	1.37	1.58	1.79	1.99	2.18	2.34*	2.40*	2.47*	
2,500	1.05	1.16	1.21	1.32	1.50	1.70	1.93	2.16*	2.41*	2.52*		
3,000	1.03	1.15	1.21	1.32	1.50	1.71	1.93*	2.16*				
3,500	1.01	1.13	1.18	1.29	1.48	1.68*	1.89*					

Test conditions with electronic units		EN 12900/CECOMAF	ASHRAE LBP
Condensing temperature	101N0242 101N0510 101N0680	55°C	54.4°C
Ambient temperature		32°C	32°C
Suction gas temperature		32°C	32°C
Liquid temperature		no subcooling	32°C

Accessories for BD50F		Code number
Bolt joint for one comp.	Ø:16 mm	118-1917
Bolt joint in quantities	Ø:16 mm	118-1918
Snap-on in quantities	Ø:16 mm	118-1919
Remote kit (without cable)		105N9210
Secop Gateway		105N9518
DC usage:	Automobile fuse, DIN 7258 12V: 15A 24V: 7.5 A Main switch	Not deliverable from Secop
AC usage:	Fuse, 100-240V Main switch	

* fan cooling of electronic unit compulsory

Compressor speed		
Electronit unit	Resistor (R1) [Ω]	Motor speed
Code number	calculated values	[rpm]
101N0242	0	2,000
101N0510	277	2,500
101N0680	692	3,000
	1523	3,500
101N0340 with AEO	0	AEO
	173	2,000
	450	2,500
	865	3,000
	1696	3,500

In AEO (Adaptive Energy Optimizing) speed mode the BD compressor will always adapt its speed to the actual cooling demand.

Wire dimensions DC						
Cross section	Size		Max. length* 12V operation		Max. length* 24V operation	
	[mm²]	[Gauge]	[m]	[ft.]	[m]	[ft.]
2.5	12		2.5	8	5	16
4	12		4	13	8	26
6	10		6	20	12	39
10	8		10	33	20	66

*Length between battery and electronic unit

Wire dimensions AC
Cross section min. 0.75 mm² or AWG 18

Operational errors	
Error code or LED flashes	Error type
	Can be read out in the software TOOL4COOL®
6	Thermostat failure (If the NTC thermistor is short-circuit or has no connection).
5	Thermal cut-out of electronic unit (If the refrigeration system has been too heavily loaded, or if the ambient temperature is high, the electronic unit will run too hot).
4	Minimum motor speed error (If the refrigeration system is too heavily loaded, the motor cannot maintain minimum speed at approximately 1,850 rpm).
3	Motor start error (The rotor is blocked or the differential pressure in the refrigeration system is too high (>5 bar)).
2	Too many start attempts or fan over current (Too many compressor or fan starts in short time or fan current higher than 0.5A _{avg}).
1	Battery protection cut-out (The voltage is outside the cut-out setting).

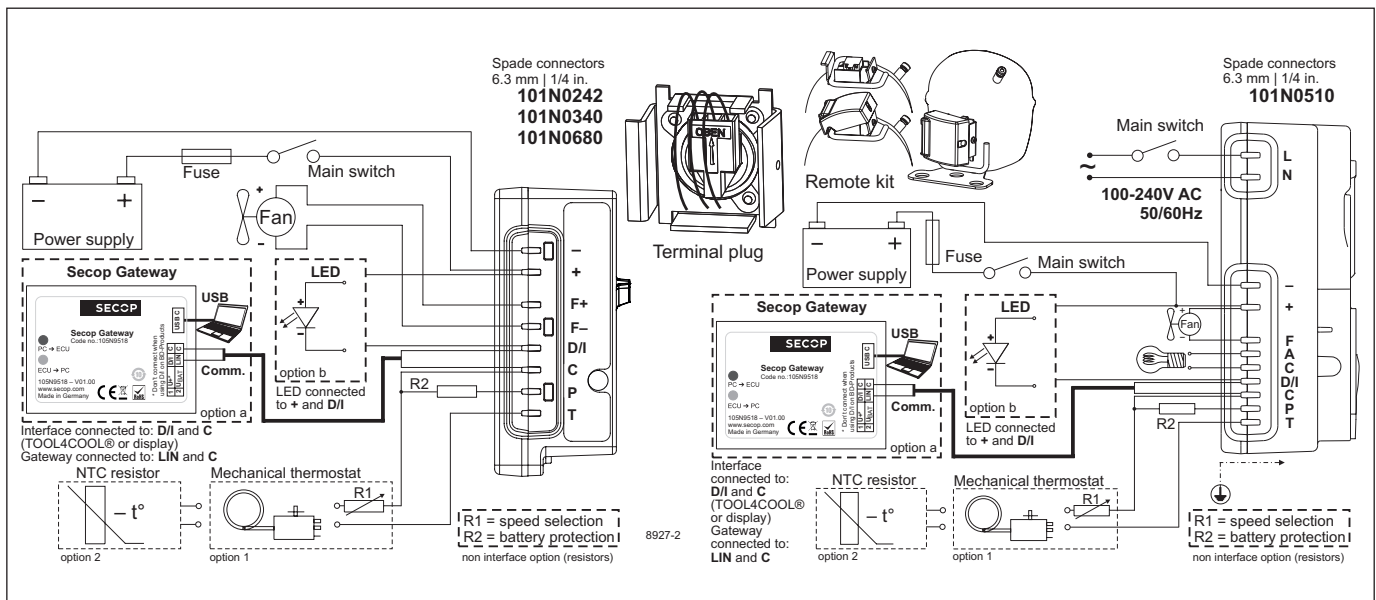

Performance Data with Refrigerant R1234yf

Capacity (EN 12900 Household/CECOMAF)												
12V DC, static cooling											watt	
rpm \ °C	-30	-25	-23.3	-20	-15	-10	-5	0	5	7.2	10	15
2,000	23.4	32.3	35.9	43.5	56.7	72.1	89.7	109	131*	142*	155*	
2,500	28.9	39.6	43.8	52.8	68.8	88.0	110	136*	166*	181*		
3,000	34.7	48.0	53.1	64.1	83.4	106	133*	163*				
3,500	42.1	57.6	63.6	76.5	99.0	126*	156*					

Capacity (ASHRAE LBP)												
12V DC, static cooling											watt	
rpm \ °C	-30	-25	-23.3	-20	-15	-10	-5	0	5	7.2	10	15
2,000	30.1	41.6	46.2	56.0	73.1	93.0	116	141	170*	183*	201*	
2,500	37.3	51.1	56.5	68.2	88.9	114	143	177*	216*	235*		
3,000	44.6	61.7	68.4	82.6	108	137	171*	211*				
3,500	54.2	74.1	81.9	98.5	128	162*	202*					

Power consumption												
12V DC, static cooling											watt	
rpm \ °C	-30	-25	-23.3	-20	-15	-10	-5	0	5	7.2	10	15
2,000	26.7	32.8	34.9	39.0	45.3	51.8	58.5	65.5	72.9*	76.2*	80.5*	
2,500	33.3	42.0	44.9	50.5	58.8	66.9	74.8	82.4*	89.7*	92.8*		
3,000	40.1	50.7	54.2	60.9	70.7	80.2	89.5*	98.4*				
3,500	49.1	59.9	63.6	70.8	82.0	93.6*	106*					

Current consumption (for 24V applications the following must be halved)												
12V DC, static cooling											A	
rpm \ °C	-30	-25	-23.3	-20	-15	-10	-5	0	5	7.2	10	15
2,000	2.2	2.7	2.9	3.2	3.8	4.3	4.9	5.5	6.1*	6.3*	6.7*	
2,500	2.8	3.5	3.7	4.2	4.9	5.6	6.2	6.9*	7.5*	7.7*		
3,000	3.3	4.2	4.5	5.1	5.9	6.7*	7.5*	8.2*				
3,500	4.1	5.0	5.3	5.9	6.8	7.8*	8.8*					

COP (EN 12900 Household/CECOMAF)												
12V DC, static cooling											W/W	
rpm \ °C	-30	-25	-23.3	-20	-15	-10	-5	0	5	7.2	10	15
2,000	0.87	0.98	1.02	1.11	1.24	1.38	1.52	1.65	1.78*	1.84*	1.91*	
2,500	0.87	0.94	0.97	1.04	1.17	1.31	1.47	1.64*	1.84*	1.93*		
3,000	0.87	0.94	0.98	1.05	1.17	1.31	1.47*	1.64*				
3,500	0.86	0.96	1.00	1.08	1.20	1.33*	1.47*					

COP (ASHRAE LBP)												
12V DC, static cooling											W/W	
rpm \ °C	-30	-25	-23.3	-20	-15	-10	-5	0	5	7.2	10	15
2,000	1.13	1.27	1.33	1.44	1.61	1.80	1.98	2.16	2.33*	2.41*	2.50*	
2,500	1.12	1.22	1.26	1.35	1.51	1.70	1.91	2.15*	2.41*	2.53*		
3,000	1.11	1.22	1.26	1.36	1.52	1.71	1.92*	2.14*				
3,500	1.10	1.24	1.29	1.39	1.56	1.73*	1.91*					

* fan cooling of electronic unit compulsory

Test conditions with electronic units		EN 12900/CECOMAF	ASHRAE LBP
Condensing temperature	101N0242 101N0510 101N0680	55°C	54.4°C
Ambient temperature		32°C	32°C
Suction gas temperature		32°C	32°C
Liquid temperature		no subcooling	32°C

Accessories for BD50F		Code number
Bolt joint for one comp.	Ø:16 mm	118-1917
Bolt joint in quantities	Ø:16 mm	118-1918
Snap-on in quantities	Ø:16 mm	118-1919
Remote kit (without cable)		105N9210
Secop Gateway		105N9518
DC usage:	Automobile fuse, DIN 7258 12V: 15A 24V: 7.5 A Main switch	Not deliverable from Secop
AC usage:	Fuse, 100-240V Main switch	

Compressor speed

Electronit unit	Resistor (R1) [Ω]	Motor speed
Code number	calculated values	[rpm]
101N0242	0	2,000
101N0510	277	2,500
101N0680	692	3,000
	1523	3,500
101N0340 with AEO	0	AEO
	173	2,000
	450	2,500
	865	3,000
	1696	3,500

In AEO (Adaptive Energy Optimizing) speed mode the BD compressor will always adapt its speed to the actual cooling demand.

Wire dimensions DC

Cross section	Size		Max. length* 12V operation		Max. length* 24V operation	
	[mm²]	[Gauge]	[m]	[ft.]	[m]	[ft.]
2.5	12		2.5	8	5	16
4	12		4	13	8	26
6	10		6	20	12	39
10	8		10	33	20	66

*Length between battery and electronic unit

Wire dimensions AC

Cross section min. 0.75 mm² or AWG 18

Operational errors

Error code or LED flashes	Error type
	Can be read out in the software TOOL4COOL®
6	Thermostat failure (If the NTC thermistor is short-circuit or has no connection).
5	Thermal cut-out of electronic unit (If the refrigeration system has been too heavily loaded, or if the ambient temperature is high, the electronic unit will run too hot).
4	Minimum motor speed error (If the refrigeration system is too heavily loaded, the motor cannot maintain minimum speed at approximately 1,850 rpm).
3	Motor start error (The rotor is blocked or the differential pressure in the refrigeration system is too high (>5 bar)).
2	Too many start attempts or fan over current (Too many compressor or fan starts in short time or fan current higher than 0.5A _{avg}).
1	Battery protection cut-out (The voltage is outside the cut-out setting).

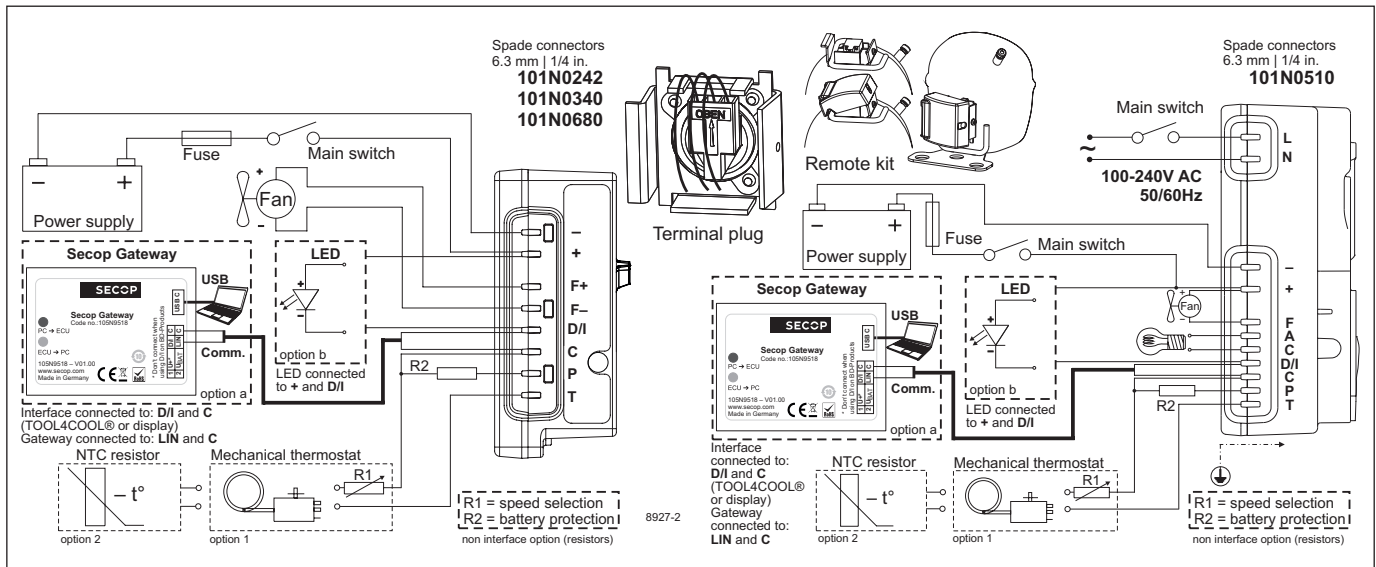

Secop accepts no responsibility for possible errors in catalogs, brochures, and other printed material. Secop reserves the right to alter its products without notice. This also applies to products already on order provided that such alterations can be made without subsequent changes being necessary to specifications already agreed. All trademarks in this material are the property of the respective companies. Secop and the Secop logotype are trademarks of Secop GmbH. All rights reserved. www.secop.com



Instructions for Electronic Units
are available for download on
www.secop.com



BD Compressors



Service/Repair

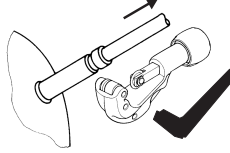

BD Nano

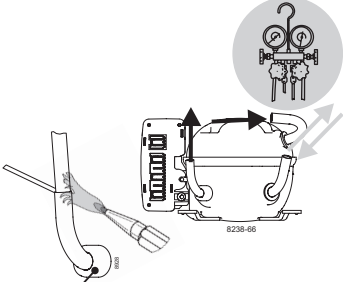

**! max. 150°C/302°F !
at socket**
brazing solder: silver with flux

Do not heat up the bottom of the discharge connector directly.
Do not braze longer than 10 seconds and wait for 5 minutes for the next soldering attempt (Product Bulletin DES.N.101.M1).

BD Micro

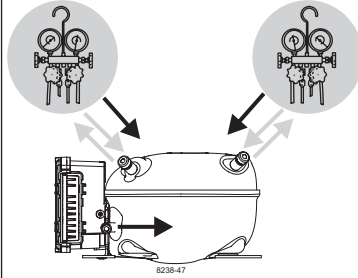

BD P-Housing

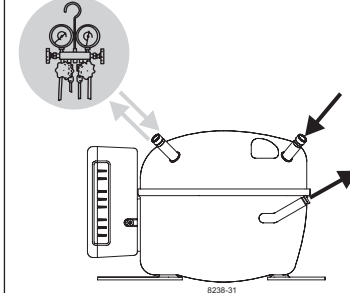

BD T-Housing

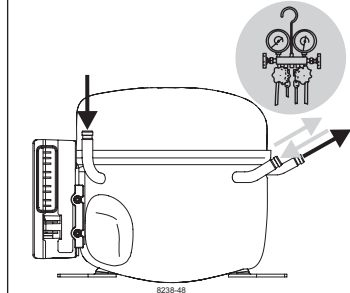

Secop accepts no responsibility for possible errors in catalogs, brochures, and other printed material. Secop reserves the right to alter its products without notice. This also applies to products already on order provided that such alterations can be made without subsequent changes being necessary to specifications already agreed. All trademarks in this material are the property of the respective companies. Secop and the Secop logotype are trademarks of Secop GmbH. All rights reserved. www.secop.com