

Single Pack SC10CNX 220-240V 50Hz CSCR

Single pack code number: **195B4338**

Position	Title	Code	Amount
1	Compressor SC10CNX	104H8065	1
2	SC starting device (550mm)	117-7025	1
3	Cord relief	103N1004	1
4	Cover	103N2009	1
5	Bolt joint for one compressor M6 ø16mm	118-1917	1

Secop GmbH • Lise-Meitner-Straße 29 • 24941 Flensburg, Germany • Tel: +49 461 4941 0 • www.secop.com

Secop accepts no responsibility for possible errors in catalogs, brochures, and other printed material. Secop reserves the right to alter its products without notice. This also applies to products already on order provided that such alterations can be made without subsequent changes being necessary to specifications already agreed. All trademarks in this material are the property of the respective companies. Secop and the Secop logotype are trademarks of Secop GmbH. All rights reserved.

Model

Designation	SC10CNX	220-240V/50Hz 1~	Sales code:	104H8065
-------------	----------------	------------------	-------------	-----------------

Compressor design

Oil type	Polyolester	Refrigerant(s)	R290
Oil viscosity	32cST	Displacement	10,29cm ³ / 0,63cu.in
Oil quantity	499cm ³ / 16,9fl.oz	Compressors on pallet	80
Refr. charge - tech. limit	150g / 5,3oz		
Free gas volume comp.	1410cm ³ / 47,7fl.oz		
Weight	13,1kg / 28,9lbs		
Motor protection	1# internal		
Winding resistance main	7,19Ω (at 25°C)		
Winding resistance aux	27,23Ω (at 25°C)		
Max. winding temp.	125°C / 257°F		
Max. discharge temp.	120°C / 248°F		



General - Configurations with SC10CNX

	Conf. 1
Motorconfiguration	CSCR
Power supply (nominal)	220-240V/50Hz
Number of phases	1
Voltage range	198-254V
Approvals	VDE
Starting torque	HST
Note	- / -

Applications with SC10CNX

	Conf. 1
Refrigerant	R290
Application	LBP+MBP
System cooling	fan 3m/s
Hot gas defrost	OK
Long interval pull down	OK

Electrical data - Configurations with SC10CNX

	Conf. 1
Starting device type	relay
Run capacitor	5μF
Start capacitor	40μF
LRA (locked rotor amps / 4s)	23,4A
RLA (rated load amps / 1s)	4,3A
Cut in current	23,4A

Model

Designation

SC10CNX

220-240V/50Hz 1~

Sales code:

104H8065

Compressor dimensions

Housing	A Height	209mm / 8,23in
	B Height	203mm / 7,99in
	C Length shell	218mm / 8,58in
	D Length w. cover	255mm / 10,04in
	E Width	151mm / 5,94in

Connectors	Suction X	Discharge Y	Process Z
Diameter [mm]	ø 8,11-8,29	ø 6,11-6,29	ø 6,11-6,29
(i:inside, o:outside) [in]	ø 0,32-0,33	ø 0,24-0,25	ø 0,24-0,25
Material	copper	copper	copper
Horizontal angle ±2°	37°	37°	143°
Vertical angle ±2°	30°	0°	150°
Position l/h/w [mm]	107/183/55	115/100/63	-107/183/55
[in]	4,2/7,2/2,2	4,5/3,9/2,5	-4,2/7,2/2,2
Straight tube l. [mm]	12	12	12
[in]	0,5	0,5	0,5



Compressor fixation



Bolt joint



Snap-on



Mounting accessories

Mounting accessories	one comp.	multi pack
Bolt joint M6 ø16mm	118-1917	118-1918
Bolt joint ø1/4" ø16mm	118-1946	
Bolt joint ø1/4" ø19mm	118-1949	
Snap-on ø7,3 ø16mm	118-1947	118-1919

Application notes

Provision for PE Grounding is located at the PE Stamp on the compressor

Model

Designation	SC10CNX	220-240V/50Hz	Conf. 1	Sales code:	104H8065
-------------	----------------	----------------------	----------------	-------------	-----------------

Configuration

Motorconfiguration	CSCR
Power supply (nominal)	220-240V/50Hz 1~
Refrigerant	R290
Application	LBP+MBP
Voltage range	198-254V
Starting torque	HST
Approvals	VDE

Electrical accessories / wiring diagram

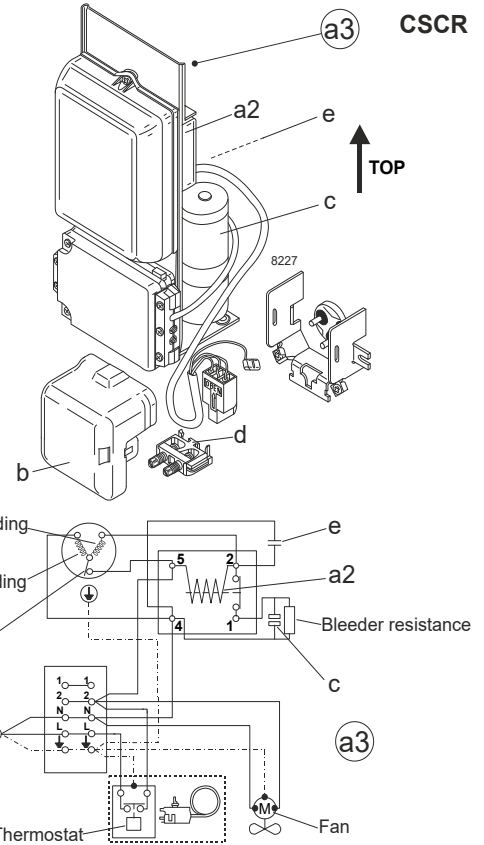

Ambient/ machine room temperatures minimum /maximum

Ambient temperature range:	10 - 43°C / 50 - 110°F
Machine room temperature range:	10 - 48°C / 50 - 119°F
Compressor cooling:	fan 3m/s

Operation Limits

Operation pressure range

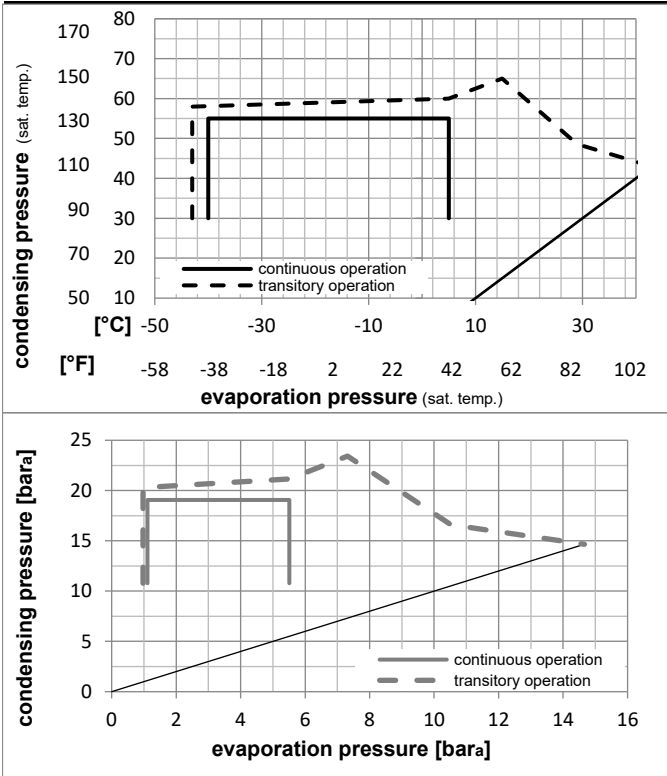

Components

a3	SC starter kit	117-7025
b	plastic cover	103N2009
d	cord relief	103N1004

Alternative components

a2	potential relay (RVA 6M3R 339)	117-7425
e	run capacitor (5µF, 6.3mm)	117-7111
c	start capacitor (40µF, 6.3mm)	117U5372
b	plastic cover	103N2009
d	cord relief	103N1004

Model

Designation **SC10CNX** **220-240V/50Hz** Conf. 1 Sales code: **104H8065**

Optimization + standard conditions

R290, 220V/50Hz, CSCR, fan 3m/s, VDE

		Evaporating pressure (saturation temperature)				Condensing pressure (saturation temperature)			Return gas temp.			Liquid temp.			Cooling capacity			COP	EER	Power consumption			
		pe	pc	RGT	Tliq	[W]	[Btu/h]	[kcal/h]	[W/W]	[Btu/Wh]	[kcal/Wh]	P1	I	Ref. mass flow									
[°C]	[°F]	[°C]	[°F]	[°C]	[°F]							[W]	[A]	[kg/h]									
-23	-10	54	130	32	90	357,3	1220	307,5	1,26	4,32	1,09	282,7	1,50	3,62							ASHRAE LBP		
54	130	32	90	32	90																		
-25	-13	55	131	32	90	263,2	899	226,5	0,98	3,33	0,84	269,8	1,46	3,28							cecomaf LBP		
55	131	32	90	32	90																		
-35	-31	40	104	20	68	197,2	673	169,7	0,93	3,16	0,80	213,0	1,23	2,25							EN12900 LBP		
40	104	20	68	20	68																		
-7	20	54	130	35	95	711,8	2431	612,6	1,79	6,11	1,54	398,1	1,96	8,12							ASHRAE MBP		
54	130	35	95	46	115																		
-10	14	55	131	32	90	555,1	1896	477,7	1,47	5,03	1,27	377,0	1,87	7,02							cecomaf MBP		
55	131	32	90	32	90																		
-10	14	45	113	20	68	634,4	2167	546,0	1,75	5,99	1,51	361,9	1,78	7,79							EN12900 MBP		
45	113	20	68	45	113																		

Performance tables

R290, 220V/50Hz, CSCR, fan 3m/s, VDE

	pe		Cooling capacity			COP	EER	P1	I	m	
	[°C]	[°F]	[W]	[Btu/h]	[kcal/h]	[W/W]	[Btu/Wh]	[kcal/Wh]	[W]	[A]	[kg/h]
[°C / °F]	-40	-40	126,1	431	108,5	0,72	2,47	0,62	174,5	1,12	1,41
cond. pressure	-35	-31	179,4	613	154,4	0,86	2,94	0,74	208,3	1,22	2,01
pc= 45/113	-30	-22	245,2	837	211,0	1,01	3,46	0,87	241,8	1,33	2,76
return gas temp.	-25	-13	324,7	1109	279,5	1,18	4,04	1,02	274,5	1,44	3,66
RGT= 32/90	-15	5	531,0	1813	457,0	1,58	5,41	1,36	335,0	1,66	6,04
liquid temp	-5	23	809,4	2764	696,6	2,10	7,17	1,81	385,8	1,89	9,32
Tliq= 45/113	5	41	1171,5	4001	1008,2	2,77	9,47	2,39	422,5	2,12	13,71
[°C / °F]	-40	-40	98,8	337	85,0	0,63	2,14	0,54	157,7	1,05	1,22
cond. pressure	-35	-31	141,8	484	122,0	0,73	2,49	0,63	194,7	1,19	1,75
pc= 55/131	-30	-22	196,1	670	168,8	0,84	2,88	0,73	232,3	1,32	2,43
return gas temp	-25	-13	263,2	899	226,5	0,98	3,33	0,84	269,8	1,46	3,28
RGT= 32/90	-15	5	441,3	1507	379,8	1,29	4,40	1,11	342,7	1,73	5,55
liquid temp	-5	23	687,3	2347	591,5	1,68	5,74	1,45	409,2	2,02	8,76
Tliq= 55/131	5	41	1012,7	3458	871,5	2,18	7,44	1,87	465,0	2,30	13,13



SC Compressors





SC Compressors

Service/Repair – R290



8545



Secop accepts no responsibility for possible errors in catalogs, brochures, and other printed material. Secop reserves the right to alter its products without notice. This also applies to products already on order provided that such alterations can be made without subsequent changes being necessary to specifications already agreed. All trademarks in this material are the property of the respective companies. Secop and the Secop logotype are trademarks of Secop GmbH. All rights reserved. www.secop.com