

Single Pack BD250GH.2 48V DC PM

Single pack code number: **195B4357**

Position	Title	Code	Amount
1	Compressor BD250GH.2	101Z0405	1
2	Electronic unit - Telecom	101N0732	1
3	DC Power cable	105N9542	1
4	Temperature sensor	105N9615	1
5	Bolt joint for one compressor M6 ø16mm	118-1917	1

Secop GmbH • Lise-Meitner-Straße 29 • 24941 Flensburg, Germany • Tel: +49 461 4941 0 • www.secop.com

Secop accepts no responsibility for possible errors in catalogs, brochures, and other printed material. Secop reserves the right to alter its products without notice. This also applies to products already on order provided that such alterations can be made without subsequent changes being necessary to specifications already agreed. All trademarks in this material are the property of the respective companies. Secop and the Secop logotype are trademarks of Secop GmbH. All rights reserved.

BD250GH.2 Direct Current Compressor R134a 48V DC



General

Code number (without electronic units)	101Z0405
Electronic unit - Telecom	101N0732, 36 pcs: 101N0733
Approvals	UL
Compressors on pallet	150

Application

Application	LBP/MBP/HBP	
Evaporating temperature °C	-25 to 15	
Voltage range VDC	32 - 60	
Max. condensing temperature continuous (short) °C	60 (70)	
Max. winding temperature continuous (short) °C	125 (135)	

Cooling requirements

Application	LBP	MBP	HBP
32°C	S	S	S
38°C	S	S	S
43°C	S	S	F ₁
Remarks on application:			

Motor

Motor type	variable speed	
Resistance, all 3 windings (25°C) Ω	1.03	

Design

Displacement cm ³	2.50	
Oil quantity (type) cm ³	150 (polyolester)	
Maximum refrigerant charge g	300	
Free gas volume in compressor cm ³	870	
Weight - Compressor/Electronic unit kg	4.4/0.24	

Battery protection settings

Voltage	Min. value	Default	Max. value
Cut out (0.1 steps) VDC	32	36	60
Cut in diff. (0.1 steps) VDC	0.5	4.0	10.0

Dimensions

Height mm	A	137
	B	135
	B1	128
	B2	73
Suction connector location/I.D. mm angle	C	6.2 40°
	material comment	Cu-plated steel Al cap
Process connector location/I.D. mm angle	D	6.2 45°
	material comment	Cu-plated steel Al cap
Discharge connector location/I.D. mm angle	E	5.0 21°
	material comment	Cu-plated steel Al cap
Connector tolerance I.D. mm	±0.09, on 5.0 +0.12/+0.20	
Remarks:	Clearance between electronic unit and baseplate does not allow the snap-on option for mounting.	

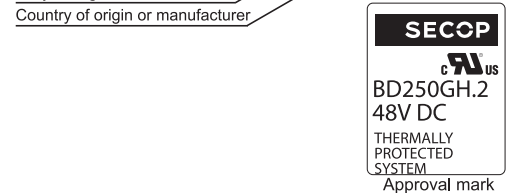
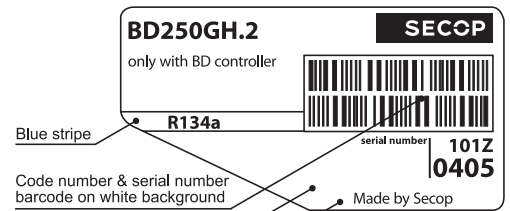

- S = Static cooling normally sufficient
- O = Oil cooling
- F₁ = Fan cooling 1.5 m/s (compressor compartment temperature equal to ambient temperature)
- F₂ = Fan cooling 3.0 m/s necessary
- SG = Suction gas cooling normally sufficient
- = not applicable in this area

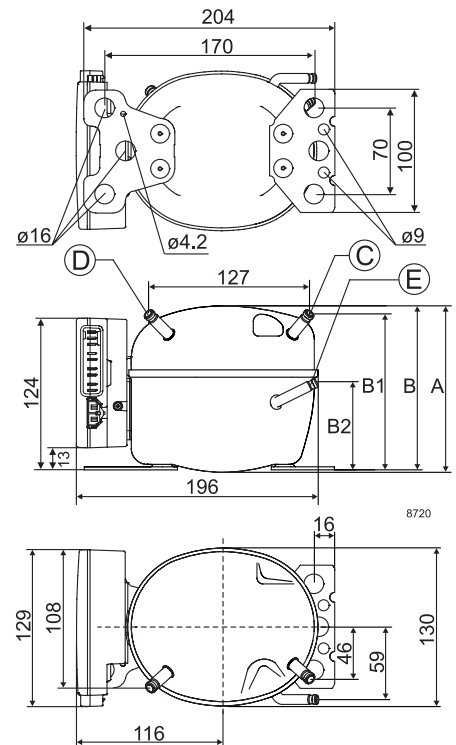

Capacity (EN 12900 Household/CECOMAF) 53V DC, fan cooling F₁ watt

rpm \ °C	-25	-23.3	-20	-15	-10	-6.7	-5	0	5	7.2	10	15
2,500	31.4	36.6	47.2	65.5	87.0	103	112	143	178	195	219	267
3,100	42.9	49.1	62.1	84.8	112	132	144	181	224	246	275	333
3,800	55.0	62.4	78.3	106	139	165	179	224	277	303	337	408
4,400	64.3	72.8	91.1	124	162	191	208	261	322	352	392	472

Capacity (ASHRAE LBP) 53V DC, fan cooling F₁ watt

rpm \ °C	-25	-23.3	-20	-15	-10	-6.7	-5	0	5	7.2	10	15
2,500	40.1	46.3	59.3	81.8	108	129	140	177	222	243	273	334
3,100	54.0	61.6	77.6	106	139	164	178	225	279	306	342	416
3,800	68.7	77.9	97.4	132	173	204	222	279	345	377	421	509
4,400	80.0	90.5	113	153	201	237	257	323	400	437	488	589

Power consumption 53V DC, fan cooling F₁ watt

rpm \ °C	-25	-23.3	-20	-15	-10	-6.7	-5	0	5	7.2	10	15
2,500	40.8	44.1	50.1	58.5	66.0	70.4	72.5	78.5	83.9	86.1	88.7	93.1
3,100	46.5	50.1	57.0	66.9	76.5	82.6	85.7	94.7	103	107	112	121
3,800	58.2	62.2	70.0	81.7	93.7	102	106	119	132	137	145	159
4,400	72.4	76.7	85.3	98.8	113	122	128	143	160	167	177	196

Current consumption 53V DC, fan cooling F₁ A

rpm \ °C	-25	-23.3	-20	-15	-10	-6.7	-5	0	5	7.2	10	15
2,500	0.78	0.86	1.01	1.23	1.43	1.55	1.60	1.75	1.87	1.91	1.95	1.98
3,100	0.65	0.74	0.90	1.14	1.38	1.52	1.59	1.79	1.97	2.04	2.12	2.23
3,800	0.87	0.96	1.13	1.40	1.67	1.85	1.94	2.20	2.45	2.55	2.68	2.89
4,400	1.36	1.45	1.64	1.93	2.24	2.44	2.55	2.86	3.17	3.30	3.47	3.76

COP (EN 12900 Household/CECOMAF) 53V DC, fan cooling F₁ W/W

rpm \ °C	-25	-23.3	-20	-15	-10	-6.7	-5	0	5	7.2	10	15
2,500	0.77	0.83	0.94	1.12	1.32	1.47	1.55	1.82	2.12	2.27	2.47	2.87
3,100	0.92	0.98	1.09	1.27	1.46	1.60	1.67	1.91	2.17	2.29	2.45	2.74
3,800	0.94	1.00	1.12	1.30	1.49	1.62	1.68	1.89	2.11	2.21	2.33	2.57
4,400	0.89	0.95	1.07	1.25	1.44	1.56	1.63	1.82	2.01	2.10	2.21	2.41

COP (ASHRAE LBP) 53V DC, fan cooling F₁ W/W

rpm \ °C	-25	-23.3	-20	-15	-10	-6.7	-5	0	5	7.2	10	15
2,500	0.98	1.05	1.19	1.41	1.66	1.84	1.95	2.28	2.67	2.86	3.12	3.63
3,100	1.16	1.23	1.37	1.59	1.83	2.00	2.09	2.39	2.72	2.87	3.07	3.45
3,800	1.18	1.25	1.40	1.62	1.85	2.01	2.10	2.36	2.64	2.76	2.92	3.22
4,400	1.10	1.18	1.33	1.55	1.79	1.94	2.02	2.27	2.51	2.62	2.76	3.02

Operational errors

Error code	Error type
	Can be read out in the software TOOL4COOL®
6	Thermostat failure (If the NTC thermistor is short-circuit or has no connection, the electronic unit will enter manual mode).
5	Thermal cut-out of electronic unit (If the refrigeration system has been too heavily loaded, or if the ambient temperature is high, the electronic unit will run too hot).
4	Minimum motor speed error (If the refrigeration system is too heavily loaded, the motor cannot maintain minimum speed at approximately 1,850 rpm).
3	Motor start error (The rotor is blocked or the differential pressure in the refrigeration system is too high).
2	Fan over-current cut-out (The fan loads the electronic unit with more than 1.8A _{peak}).
1	Battery protection cut-out (The voltage is outside the cut-out setting).

Accessories for BD250GH.2

Mounting	Code number
Bolt joint for one compressor Ø: 16 mm	118-1917
Bolt joint in quantities Ø: 16 mm	118-1918

Electrical (cables, sensors, etc.)	Code number	
	Single pack	1 - Pack
DC line cord, 900 mm	105N9542	105N9543, 36 pcs.
DC line cord, 2000 mm	105N9540	105N9541, 36 pcs.
DC line cord, 5000 mm	105N9538	105N9539, 36 pcs.
Temperature sensor 470 mm	105N9612	105N9613, 200 pcs.
Temperature sensor 1000 mm	105N9614	105N9615, 100 pcs.
Temperature sensor 1500 mm	105N9616	105N9617, 100 pcs.
Secop Gateway	105N9518	-

Test conditions	EN 12900/CECOMAF	ASHRAE LBP
Condensing temperature	55°C	54.4°C
Ambient temperature	32°C	32°C
Suction gas temperature	32°C	32°C
Liquid temperature	no subcooling	32°C

Not deliverable from Secop	
Slow-blow fuse	16A
Main switch	rated to min. 25A

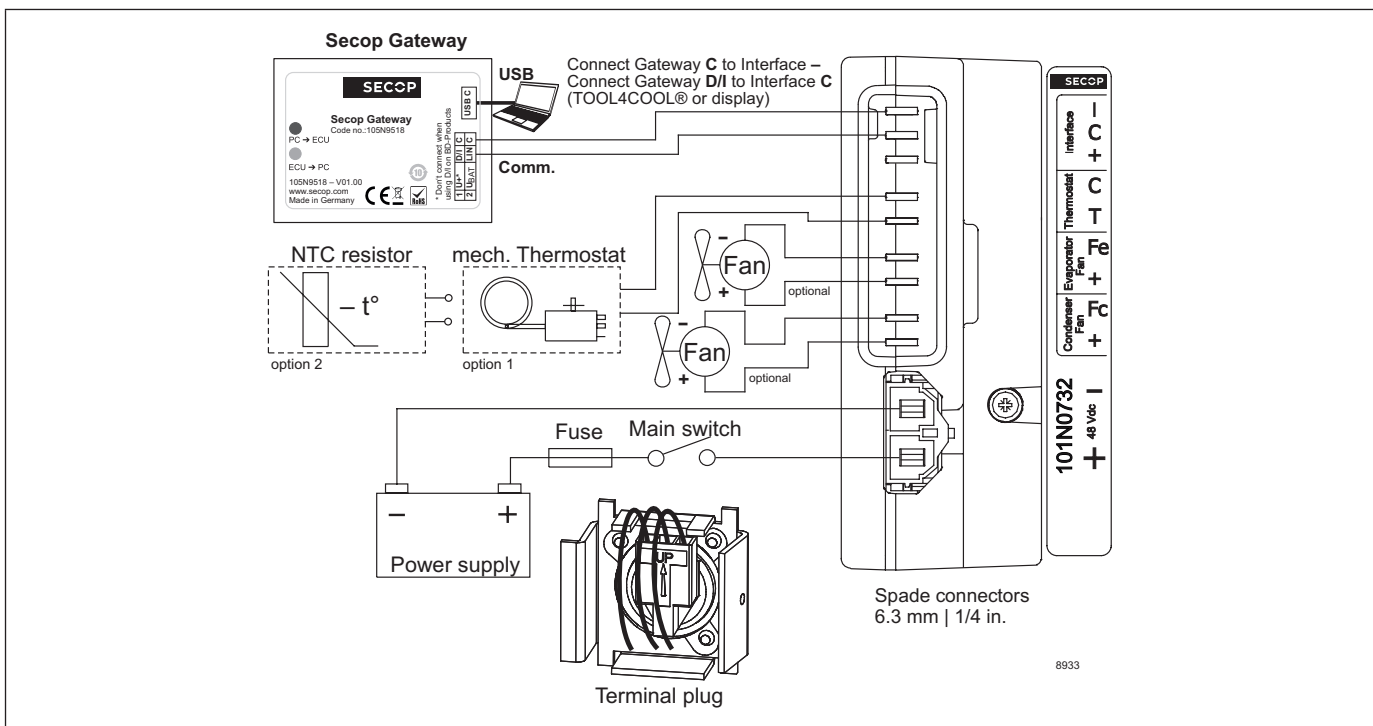

Secop accepts no responsibility for possible errors in catalogs, brochures, and other printed material. Secop reserves the right to alter its products without notice. This also applies to products already on order provided that such alterations can be made without substantial changes being necessary to specifications already agreed. All trademarks in this material are the property of the respective companies. Secop and the Secop logotype are trademarks of Secop GmbH. All rights reserved. www.secop.com



Instructions for Electronic Units
are available for download on
www.secop.com



BD Compressors



Service/Repair



BD Nano



**! max. 150°C/302°F !
at socket**
brazing solder: silver with flux

Do not heat up the bottom of the discharge connector directly.
Do not braze longer than 10 seconds and wait for 5 minutes for the next soldering attempt (Product Bulletin DES.N.101.M1).

BD Micro



BD P-Housing



BD T-Housing

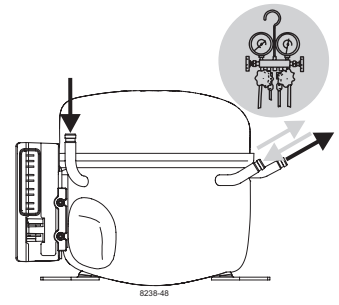

Secop accepts no responsibility for possible errors in catalogs, brochures, and other printed material. Secop reserves the right to alter its products without notice. This also applies to products already on order provided that such alterations can be made without subsequent changes being necessary to specifications already agreed. All trademarks in this material are the property of the respective companies. Secop and the Secop logotype are trademarks of Secop GmbH. All rights reserved. www.secop.com