

Single Pack DLV4.0CN 220-240V 50Hz / 208-230V 60Hz PM

Single pack code number: **195B4383**

Position	Title	Code	Amount
1	Compressor DLV4.0CN	102H3498	1
2	Motor cable (900mm)	105B4477	1
3	Electronic unit DLV	105N4511	1
4	Cord relief	103N1010	1
5	Cover	103N0492	1
6	Bolt joint in quantities M6 ø16mm	118-1918	1

Secop GmbH • Lise-Meitner-Straße 29 • 24941 Flensburg, Germany • Tel: +49 461 4941 0 • www.secop.com

Secop accepts no responsibility for possible errors in catalogs, brochures, and other printed material. Secop reserves the right to alter its products without notice. This also applies to products already on order provided that such alterations can be made without subsequent changes being necessary to specifications already agreed. All trademarks in this material are the property of the respective companies. Secop and the Secop logotype are trademarks of Secop GmbH. All rights reserved.

DLV4.0CN Variable Speed Drive Compressor R290, 220-240V 50/60Hz - with 105N4410 & 105N4510 Controllers



General

Code number (without electronic unit)	102H3498
Electronic unit (without PFC)	105N4410
Approvals: UL 60335-2-34 with Annex AA, CCC	
Electronic unit (with PFC)	105N4510
Approvals: EN 60335-2-34 with Annex AA, CCC	
Compressors on pallet	100
Remarks: PFC = power factor correction according to EN 61000-3-2:2014	

Application

Application	LBP/MBP			
	Hz	50	60	
Frequency	Hz	50	60	
Evaporating temperature	°C	-35 to 7.2	-35 to 7.2	
Voltage range / frequency	V/Hz	180 - 270	180 - 270	
Max. condensing temperature continuous (short)	°C	60 (65)	60 (65)	
Max. winding temperature continuous (short)	°C	125 (135)	125 (135)	

Cooling requirements

Frequency	Hz	50			60		
		LBP	MBP	HBP	LBP	MBP	HBP
32°C		F ₂	F ₂	-	F ₂	F ₂	-
38°C		F ₂	F ₂	-	F ₂	F ₂	-
43°C		F ₂	F ₂	-	F ₂	F ₂	-

Features

Speed range	rpm	2000 - 4500
Speed control		AEO, frequency, serial com.
Thermostat		integrated, electronic
Protections		current, speed, temperature
Protection class (electronic unit)		IP54

Motor

Motor type		permanent magnet
LRA (rated after 4 sec. UL984),	A	electronic cut off
Maximum current	A	3.1
Resistance, all 3 windings (25°C)	Ω	4.1

Design

Displacement	cm ³	4.00
Oil quantity (type)	cm ³	230 (polyolester)
Maximum refrigerant charge	g	150
Free gas volume in compressor	cm ³	1390
Weight - Compressor/Electronic unit	kg	7.8 / 0.5

Dimensions

Height	mm	A	175
		B	169
Suction connector	location/I.D. mm angle	C	8.2 18°
		material comment	Copper Rubber plug
Process connector	location/I.D. mm angle	D	6.2 61°
		material comment	Copper Rubber plug
Discharge connector	location/I.D. mm angle	E	6.2 25°
		material comment	Copper Rubber plug
Connector tolerance	I.D. mm		±0.09

Accessories

	Code number
Cover	103N0492
Cord relief	103N1010
Motor cable	900 mm cable length
	105B4477

Mounting accessories

Bolt joint for one compressor	Ø: 16 mm	118-1917
Bolt joint in quantities	Ø: 16 mm	118-1918
Snap-on in quantities	Ø: 16 mm	118-1919

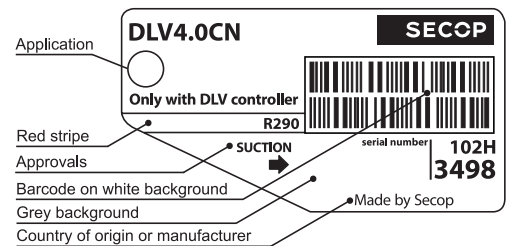

- S = Static cooling normally sufficient
- O = Oil cooling
- F₁ = Fan cooling 1.5 m/s (compressor compartment temp. equal to ambient temperature)
- F₂ = Fan cooling 3.0 m/s necessary
- SG = Suction gas cooling normally sufficient
- = not applicable in this area

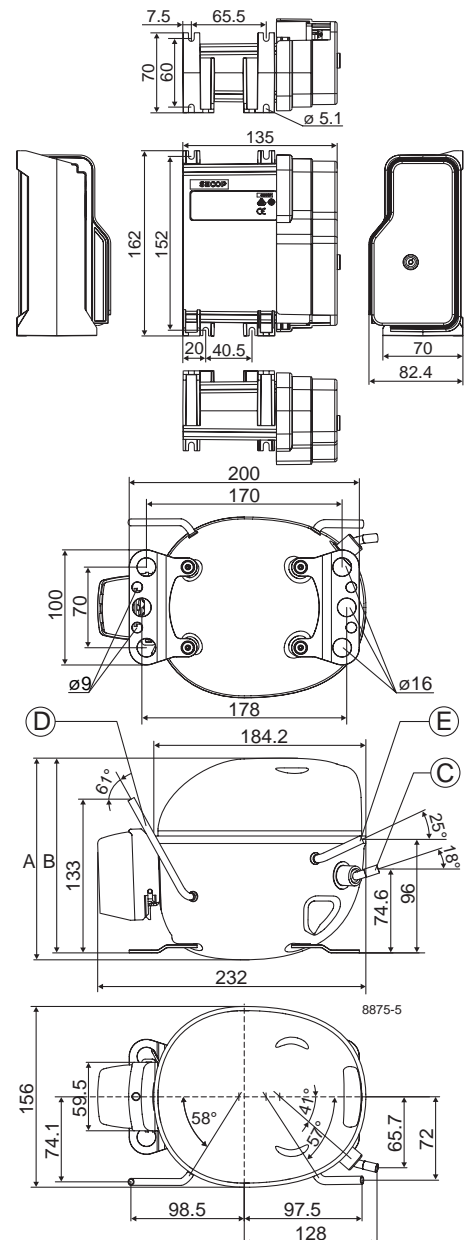

LBP: ASHRAE 230V, 50/60Hz, fan cooling F₂

Speed (rpm)	2000	2250	2500	2750	3000	3500	4000	4500
Capacity [W]	119	136	153	170	186	219	251	299
Capacity [BTU/h]	406	465	524	580	635	747	859	1022
Power cons. [W]	79	87	95	106	116	137	158	175
Current cons. [A]	0.43	0.45	0.48	0.52	0.57	0.65	0.74	0.80
COP [W/W]	1.51	1.57	1.61	1.61	1.60	1.60	1.59	1.72
EER [BTU/Wh]	5.14	5.34	5.51	5.49	5.48	5.45	5.43	5.86

Test conditions

Evaporation pressure	-23.3°C	-10°F
Condensing pressure	54.4°C	130°F
Liquid temperature	32.2°C	90°F
Return gas temperature	32.2°C	90°F

LBP: CECOMAF 230V, 50/60Hz, fan cooling F₂

Speed (rpm)	2000	2250	2500	2750	3000	3500	4000	4500
Capacity [W]	88	101	114	126	138	162	186	222
Capacity [BTU/h]	302	346	390	431	472	554	636	758
Power cons. [W]	76	84	92	102	112	132	153	169
Current cons. [A]	0.42	0.44	0.47	0.51	0.55	0.63	0.71	0.77
COP [W/W]	1.16	1.21	1.24	1.24	1.23	1.23	1.22	1.32
EER [BTU/Wh]	3.95	4.11	4.25	4.23	4.21	4.19	4.17	4.50

Test conditions

Evaporation pressure	-25°C	-13°F
Condensing pressure	55°C	131°F
Liquid temperature	55°C	131°F
Return gas temperature	32°C	90°F

LBP: EN12900 230V, 50/60Hz, fan cooling F₂

Speed (rpm)	2000	2250	2500	2750	3000	3500	4000	4500
Capacity [W]	71	79	88	98	109	130	151	168
Capacity [BTU/h]	241	270	300	335	371	443	515	574
Power cons. [W]	55	63	70	77	84	98	112	130
Current cons. [A]	0.32	0.36	0.39	0.41	0.44	0.48	0.53	0.61
COP [W/W]	1.27	1.27	1.26	1.28	1.30	1.33	1.35	1.30
EER [BTU/Wh]	4.35	4.33	4.31	4.38	4.44	4.54	4.61	4.43

Test conditions

Evaporation pressure	-35°C	-31°F
Condensing pressure	40°C	104°F
Liquid temperature	40°C	104°F
Return gas temperature	20°C	68°F

MBP: ASHRAE 230V, 50/60Hz, fan cooling F₂

Speed (rpm)	2000	2250	2500	2750	3000	3500	4000	4500
Capacity [W]	225	257	289	319	349	410	471	549
Capacity [BTU/h]	767	877	986	1090	1193	1400	1607	1875
Power cons. [W]	107	118	129	143	157	186	215	238
Current cons. [A]	0.55	0.58	0.61	0.67	0.74	0.86	0.99	1.06
COP [W/W]	2.11	2.18	2.25	2.23	2.22	2.20	2.19	2.31
EER [BTU/Wh]	7.19	7.45	7.67	7.62	7.58	7.52	7.48	7.88

Test conditions

Evaporation pressure	-6.7°C	20°F
Condensing pressure	54.4°C	130°F
Liquid temperature	46.1°C	115°F
Return gas temperature	35°C	95°F

MBP: CECOMAF 230V, 50/60Hz, fan cooling F₂

Speed (rpm)	2000	2250	2500	2750	3000	3500	4000	4500
Capacity [W]	176	201	227	251	275	323	371	436
Capacity [BTU/h]	600	687	774	857	939	1103	1268	1488
Power cons. [W]	102	113	123	137	150	178	205	227
Current cons. [A]	0.53	0.56	0.59	0.65	0.71	0.82	0.94	1.02
COP [W/W]	1.72	1.79	1.84	1.84	1.83	1.82	1.81	1.92
EER [BTU/Wh]	5.88	6.11	6.30	6.27	6.24	6.21	6.18	6.56

Test conditions

Evaporation pressure	-10°C	14°F
Condensing pressure	55°C	131°F
Liquid temperature	55°C	131°F
Return gas temperature	32°C	90°F

MBP: EN12900 230V, 50/60Hz, fan cooling F₂

Speed (rpm)	2000	2250	2500	2750	3000	3500	4000	4500
Capacity [W]	203	229	255	282	310	364	418	471
Capacity [BTU/h]	694	783	872	964	1057	1242	1427	1610
Power cons. [W]	90	101	112	124	136	160	183	209
Current cons. [A]	0.48	0.51	0.55	0.60	0.65	0.75	0.85	0.94
COP [W/W]	2.26	2.27	2.28	2.28	2.28	2.28	2.28	2.25
EER [BTU/Wh]	7.70	7.76	7.80	7.79	7.79	7.79	7.79	7.69

Test conditions

Evaporation pressure	-10°C	14°F
Condensing pressure	45°C	113°F
Liquid temperature	45°C	113°F
Return gas temperature	20°C	68°F

Optimization Point 230V, 50/60Hz, fan cooling F₂

Speed (rpm)	2000	2250	2500	2750	3000	3500	4000	4500
Capacity [W]	130	146	163	181	198	233	268	304
Capacity [BTU/h]	443	500	557	617	676	796	916	1039
Power cons. [W]	67	75	83	91	99	116	133	152
Current cons. [A]	0.37	0.40	0.44	0.47	0.50	0.56	0.63	0.70
COP [W/W]	1.95	1.96	1.98	1.98	1.99	2.00	2.01	2.00
EER [BTU/Wh]	6.66	6.71	6.75	6.78	6.8	6.84	6.87	6.83

Test conditions

Evaporation pressure	-25°C	-13°F
Condensing pressure	35°C	95°F
Liquid temperature	35°C	95°F
Return gas temperature	32°C	90°F

Optimization Point 230V, 50/60Hz, fan cooling F₂

Speed (rpm)	2000	2250	2500	2750	3000	3500	4000	4500
Capacity [W]	212	239	266	294	322	379	435	491
Capacity [BTU/h]	723	815	908	1004	1100	1293	1486	1676
Power cons. [W]	90	101	112	124	136	160	183	209
Current cons. [A]	0.48	0.51	0.55	0.60	0.65	0.75	0.85	0.94
COP [W/W]	2.35	2.36	2.38	2.38	2.38	2.38	2.37	2.35
EER [BTU/Wh]	8.02	8.07	8.12	8.11	8.11	8.11	8.11	8.01

Test conditions

Evaporation pressure	-10°C	14°F
Condensing pressure	45°C	113°F
Liquid temperature	45°C	113°F
Return gas temperature	32°C	90°F

Optimization Point 230V, 50/60Hz, fan cooling F₂

Speed (rpm)	2000	2250	2500	2750	3000	3500	4000	4500
Capacity [W]	376	424	473	522	570	667	764	856
Capacity [BTU/h]	1285	1451	1616	1782	1948	2279	2610	2923
Power cons. [W]	103	115	128	142	156	184	212	242
Current cons. [A]	0.53	0.58	0.63	0.69	0.75	0.86	0.97	1.08
COP [W/W]	3.66	3.68	3.70	3.68	3.66	3.63	3.60	3.54
EER [BTU/Wh]	12.48	12.58	12.65	12.57	12.5	12.39	12.31	12.08

Test conditions

Evaporation pressure	5°C	41°F
Condensing pressure	45°C	113°F
Liquid temperature	45°C	113°F
Return gas temperature	32°C	90°F

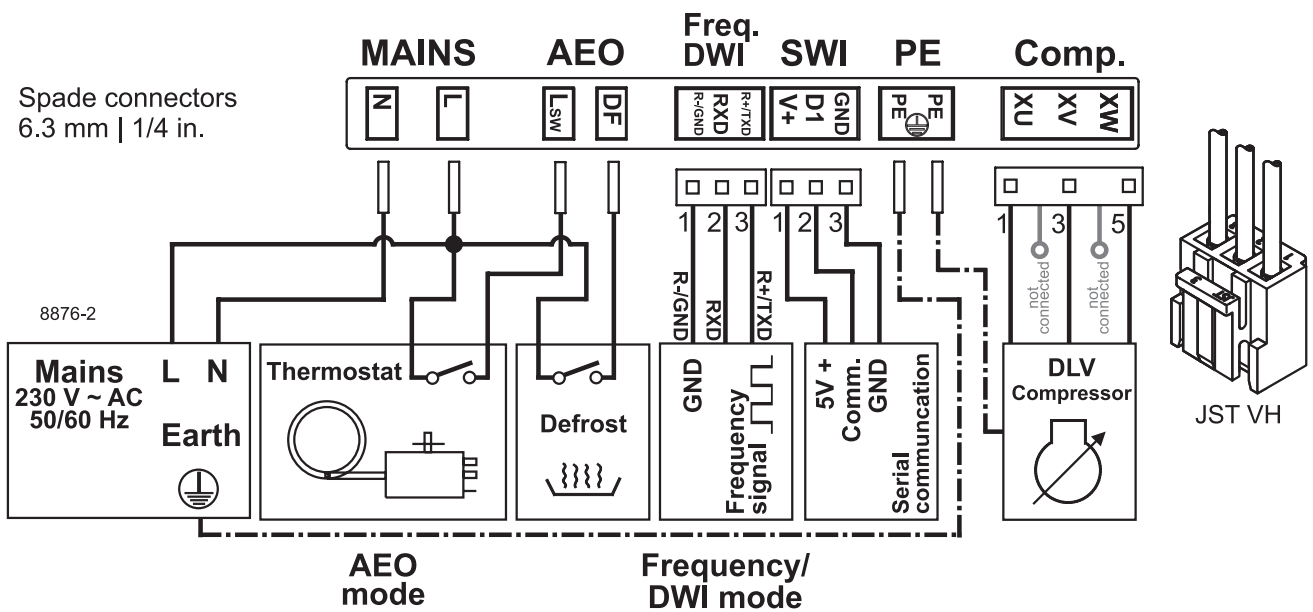

Secop accepts no responsibility for possible errors in catalogs, brochures, and other printed material. Secop reserves the right to alter its products without notice. This also applies to products already on order provided that such alterations can be made without subsequential changes being necessary to specifications already agreed. All trademarks in this material are the property of the respective companies. Secop and the Secop logotype are trademarks of Secop GmbH. All rights reserved. www.secop.com



Instructions

DLV Compressors
220-240V 50/60Hz
105N441x & 105N451x
Series Controllers





Instructions

DLV Compressors
220-240V 50/60Hz
105N441x & 105N451x
Series Controllers

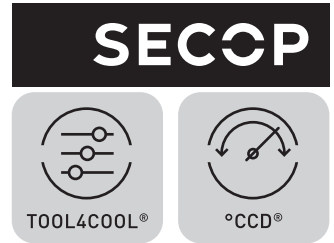

Service/Repair R290

8545

Brazing on Suction Connectors (Direct Intake)

representative image

**! max. 150°C/302°F !
at socket**

brazing solder: phosphor (LP7) or silver

Refer to Product Bulletin: **Brazing on Suction Connectors
(Compressors with Direct Suction Intake)**

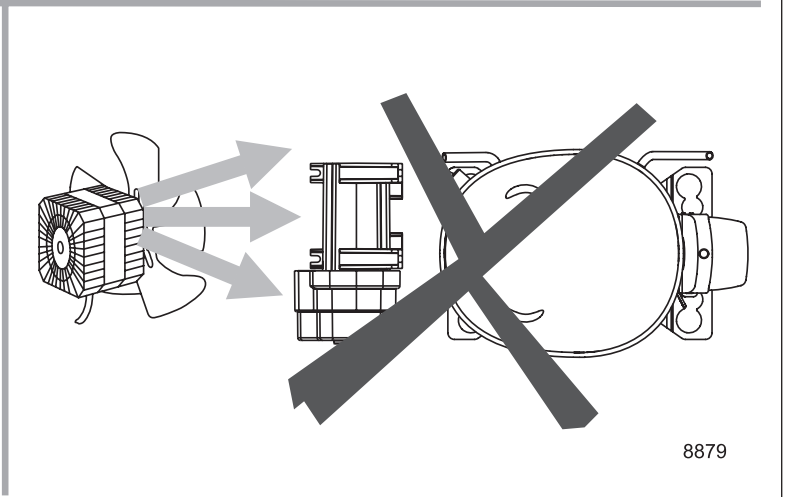
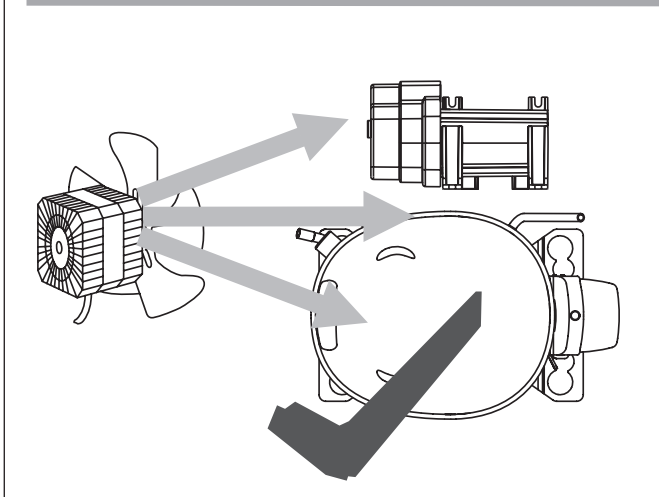
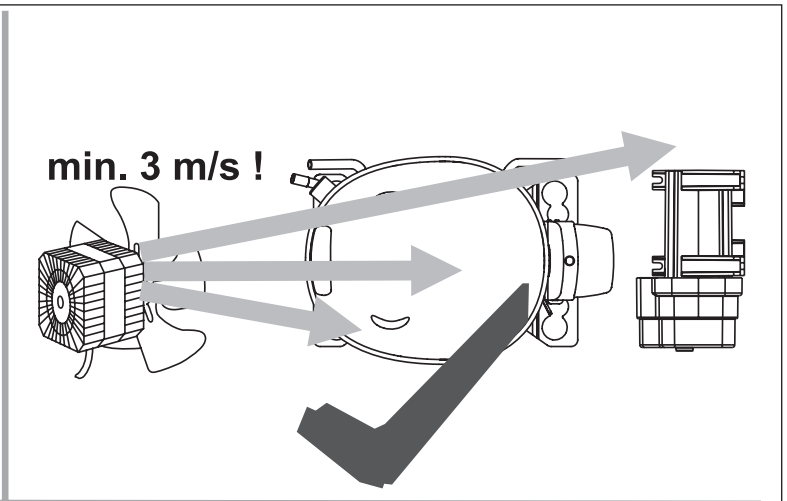
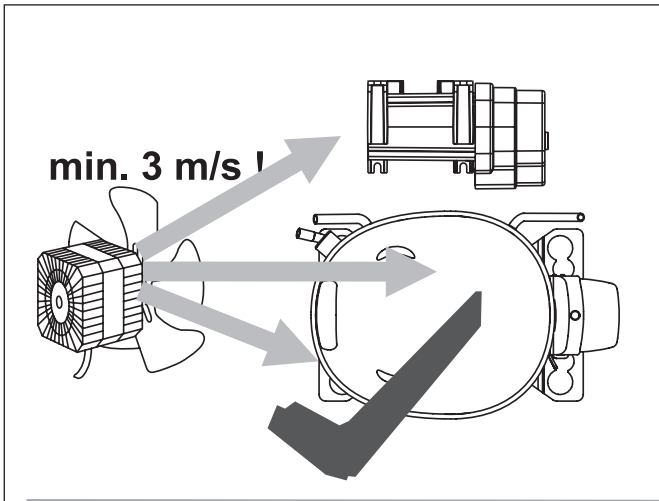

Airflow	3 m/s
Operating conditions 105N441x, 105N451x	+ 5 °C to 43 °C - humidity < 90 % rH non condensing
Storage conditions	-25 °C to 70 °C - humidity < 90 % rH non condensing
Supply voltage	220-240 V (± 10 %)
Frequency	50/60 Hz
Input power rating	450 W

Secop accepts no responsibility for possible errors in catalogs, brochures, and other printed material. Secop reserves the right to alter its products without notice. This also applies to products already on order provided that such alterations can be made without subsequent changes being necessary to specifications already agreed. All trademarks in this material are the property of the respective companies. Secop and the Secop logotype are trademarks of Secop GmbH. All rights reserved. www.secop.com