

Single Pack SC10DL 220-240V 50Hz CSIR

Single pack code number: **195B4419**

Position	Title	Code	Amount
1	Compressor SC10DL	104L2535	1
2	Starting relay	117U6005	1
3	Starting capacitor (80 μ F 220V, 6.3mm)	117U5017	1
4	Cord relief	103N1004	1
5	Cover	103N2009	1
6	Bolt joint for one compressor M6 \varnothing 16mm	118-1917	1

Secop GmbH • Lise-Meitner-Straße 29 • 24941 Flensburg, Germany • Tel: +49 461 4941 0 • www.secop.com

Secop accepts no responsibility for possible errors in catalogs, brochures, and other printed material. Secop reserves the right to alter its products without notice. This also applies to products already on order provided that such alterations can be made without subsequent changes being necessary to specifications already agreed. All trademarks in this material are the property of the respective companies. Secop and the Secop logotype are trademarks of Secop GmbH. All rights reserved.

Model

Designation	SC10DL	220-240V/50Hz 1~	Sales code:	104L2535
-------------	---------------	-------------------------	-------------	-----------------

Compressor design

Oil type	Polyolester	Refrigerant(s)	R404A, R507, R407C
Oil viscosity	32cST	Displacement	10,29cm ³ / 0,63cu.in
Oil quantity	550cm ³ / 18,6fl.oz	Compressors on pallet	80
Refr. charge - tech. limit	1300g / 45,9oz		
Free gas volume comp.	1410cm ³ / 47,7fl.oz		
Weight	13,2kg / 29,1lbs		
Motor protection	1# internal		
Winding resistance main	5,13Ω (at 25°C)		
Winding resistance aux	13,51Ω (at 25°C)		
Max. winding temp.	125°C / 257°F		
Max. discharge temp.	130°C / 266°F		



General - Configurations with SC10DL

Conf. 1

Motorconfiguration	CSIR
Power supply (nominal)	220-240V/50Hz
Number of phases	1
Voltage range	198-254V
Approvals	VDE, CCC
Starting torque	HST
Note	- / -

Applications with SC10DL

Conf. 1

Refrigerant	R404A
Application	HBP
System cooling	fan 3m/s
Hot gas defrost	OK
Long interval pull down	OK

Electrical data - Configurations with SC10DL

Conf. 1

Starting device type	relay
Run capacitor	-/-
Start capacitor	80μF
LRA (locked rotor amps / 4s)	16,2A
RLA (rated load amps / 1s)	3,1A
Cut in current	16,2A

Model

Designation	SC10DL	220-240V/50Hz 1~	Sales code:	104L2535
-------------	---------------	-------------------------	-------------	-----------------

Compressor dimensions

Housing	A Height	209mm / 8,23in
	B Height	203mm / 7,99in
	C Length shell	218mm / 8,58in
	D Length w. cover	255mm / 10,04in
	E Width	151mm / 5,94in



Connectors	Suction		Discharge		Process	
	X		Y		Z	
Diameter [mm]	øi 8,11-8,29		øi 6,11-6,29		øi 6,11-6,29	
(i:inside, o:outside) [in]	øi 0,32-0,33		øi 0,24-0,25		øi 0,24-0,25	
Material	copper		copper		copper	
Horizontal angle ±2°	37°		37°		143°	
Vertical angle ±2°	30°		0°		150°	
Position l/h/w [mm]	107/183/55		115/100/63		-107/183/55	
[in]	4,2/7,2/2,2		4,5/3,9/2,5		-4,2/7,2/2,2	
Straight tube l. [mm]	12		12		12	
[in]	0,5		0,5		0,5	

Compressor fixation

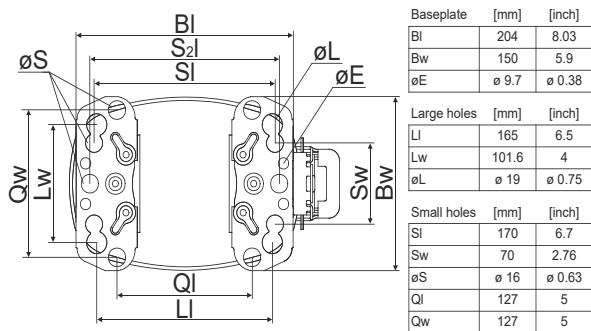

Baseplate	[mm]	[inch]
BI	204	8.03
Bw	150	5.9
øE	ø 9.7	ø 0.38
Large holes		
	[mm]	[inch]
LI	165	6.5
Lw	101.6	4
øL	ø 19	ø 0.75
Small holes		
	[mm]	[inch]
SI	170	6.7
Sw	70	2.76
øS	ø 16	ø 0.63
QI	127	5
Qw	127	5

Bolt joint

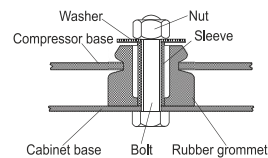

Snap-on

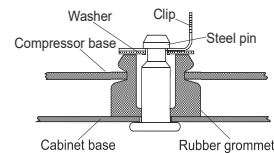

Mounting accessories

	one comp.	multi pack
Bolt joint M6 ø16mm	118-1917	118-1918
Bolt joint ø1/4" ø16mm	118-1946	
Bolt joint ø1/4" ø19mm	118-1949	
Snap-on ø7,3 ø16mm	118-1947	118-1919

Application notes

Provision for PE Grounding is located at the PE Stamp on the compressor

Model

Designation	SC10DL	220-240V/50Hz	Conf. 1	Sales code:	104L2535
-------------	---------------	----------------------	---------	-------------	-----------------

Configuration

Motorconfiguration	CSIR
Power supply (nominal)	220-240V/50Hz 1~
Refrigerant	R404A
Application	HBP
Voltage range	198-254V
Starting torque	HST
Approvals	VDE CCC

Electrical accessories / wiring diagram

CSIR

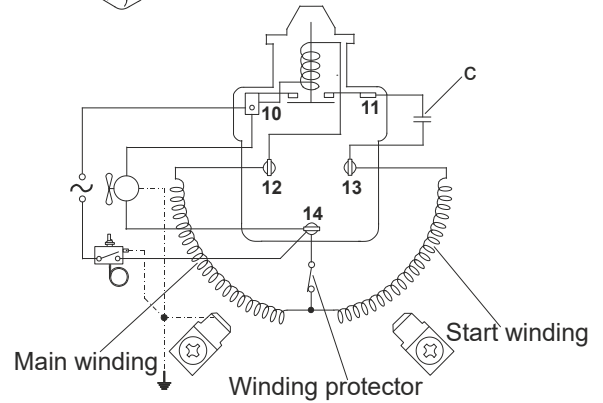
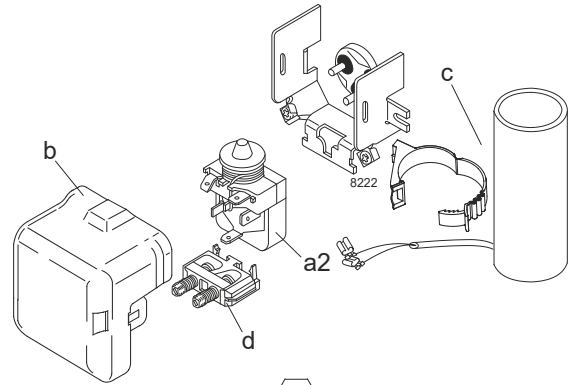

Ambient/ machine room temperatures minimum /maximum

Ambient temperature range: 10 - 38°C / 50 - 101°F

Machine room temperature range: 10 - 43°C / 50 - 110°F

Compressor cooling: fan 3m/s

Operation Limits

Operation pressure range

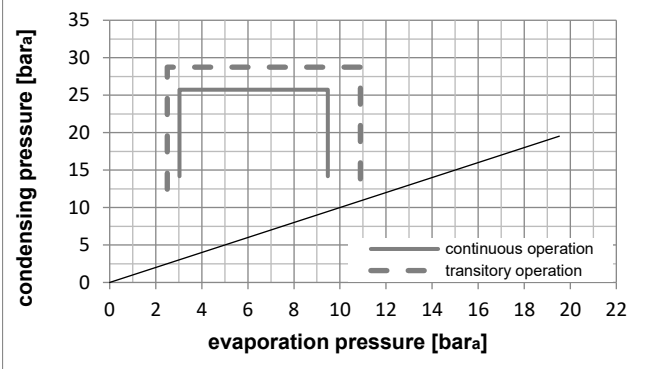
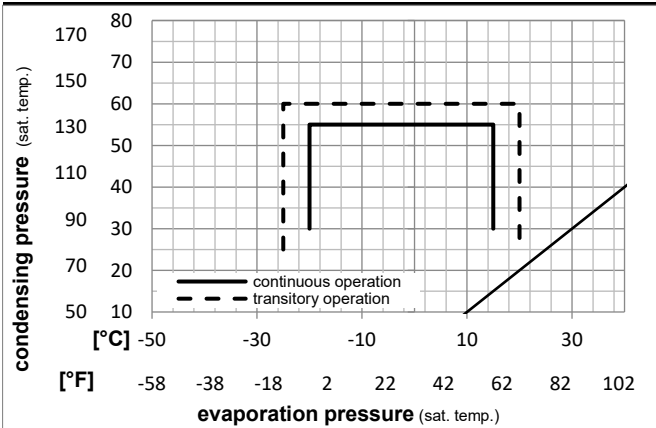

Components

a2	relay	117U6005
c	start capacitor (80μF)	117U5017
d	cord relief	103N1004
b	plastic cover	103N2009

Model

Designation	SC10DL	220-240V/50Hz	Conf. 1	Sales code:	104L2535
-------------	---------------	----------------------	----------------	-------------	-----------------

Optimization + standard conditions

R404A, 220V/50Hz, CSIR, fan 3m/s, VDE, CCC

	Evaporating pressure (saturation temperature)				Cooling capacity			COP	EER	P1	Power consumption		Ref. mass flow	ASHRAE HBP
	pe	pc	RGT	Tliq	[W]	[Btu/h]	[kcal/h]				[A]	[kg/h]		
[°C]	7,2	54	35	46	1478,2	5048	1272,2	2,15	7,35	1,85	686,7	3,80	42,03	ASHRAE HBP
[°F]	45	130	95	115										
[°C]	5	55	32	55	1156,0	3948	994,8	1,71	5,85	1,47	674,9	3,74	38,50	cecomaf HBP
[°F]	41	131	90	131										
[°C]	5	50	20	50	1208,0	4126	1039,6	1,92	6,56	1,65	628,6	3,57	41,20	EN12900 HBP
[°F]	41	122	68	122										
[°C]	-7	54	35	46	838,2	2862	721,3	1,51	5,16	1,30	554,9	3,27	23,06	ASHRAE MBP
[°F]	20	130	95	115										
[°C]	-10	55	32	55	613,6	2096	528,1	1,19	4,05	1,02	517,8	3,12	19,64	cecomaf MBP
[°F]	14	131	90	131										
[°C]	-10	45	20	45	730,5	2495	628,7	1,53	5,21	1,31	478,5	2,97	22,00	EN12900 MBP
[°F]	14	113	68	113										

Performance tables

R404A, 220V/50Hz, CSIR, fan 3m/s, VDE, CCC

	pe		Cooling capacity			COP	EER		P1	I	m
	[°C]	[°F]	[W]	[Btu/h]	[kcal/h]		[Btu/Wh]	[kcal/Wh]			
[°C / °F]	-20	-4	471,3	1610	405,6	1,26	4,31	1,09	373,4	2,55	12,79
cond. pressure	-15	5	610,8	2086	525,7	1,42	4,86	1,23	428,9	2,78	16,69
pc= 45/113	-10	14	775,2	2648	667,2	1,62	5,53	1,39	478,5	2,97	21,35
return gas temp.	-5	23	967,8	3305	832,9	1,85	6,33	1,60	522,0	3,15	26,91
RGT= 32/90	0	32	1191,8	4070	1025,6	2,13	7,28	1,83	559,2	3,30	33,50
liquid temp	5	41	1450,4	4953	1248,2	2,46	8,40	2,12	589,9	3,42	41,32
Tliq= 45/113	15	59	2084,9	7120	1794,3	3,30	11,28	2,84	631,1	3,61	61,48
[°C / °F]	-20	-4	349,8	1195	301,0	0,92	3,15	0,79	378,8	2,59	11,01
cond. pressure	-15	5	474,1	1619	408,0	1,05	3,59	0,90	451,6	2,87	15,04
pc= 55/131	-10	14	613,6	2096	528,1	1,19	4,05	1,02	517,8	3,12	19,64
return gas temp	-5	23	771,6	2635	664,0	1,34	4,57	1,15	577,2	3,35	24,97
RGT= 32/90	0	32	951,2	3249	818,7	1,51	5,16	1,30	629,6	3,56	31,19
liquid temp	5	41	1156,0	3948	994,8	1,71	5,85	1,47	674,9	3,74	38,50
Tliq= 55/131	15	59	1653,5	5647	1423,0	2,22	7,60	1,91	743,4	4,04	57,34



SC Compressors





SC Compressors

Service/Repair – R290



8545



Secop accepts no responsibility for possible errors in catalogs, brochures, and other printed material. Secop reserves the right to alter its products without notice. This also applies to products already on order provided that such alterations can be made without subsequent changes being necessary to specifications already agreed. All trademarks in this material are the property of the respective companies. Secop and the Secop logotype are trademarks of Secop GmbH. All rights reserved. www.secop.com