

Single Pack HTK80AA 220-240V 50Hz RSCR

Single pack code number: **195B4579**

Position	Title	Code	Amount
1	Compressor HTK80AA	16068300	1
2	Clip	10633900	4
3	Steel pin	10634100	4
4	Washer	10634300	4
5	Screw for cable clamp	10636000	1
6	Screw for cable clamp	10636200	1
7	Cover	10636401	1
8	Earth screw	10641201	1
9	Run capacitor (3 μ F 400V, 4.8mm)	10692902	1
10	Rubber grommet 16mm	11322600	4
11	Cable clamp	11341000	1
12	Terminal board 4.8mm	15164300	1
13	Evaporation tray	16299100	1

Secop GmbH • Lise-Meitner-Straße 29 • 24941 Flensburg, Germany • Tel: +49 461 4941 0 • www.secop.com

Secop accepts no responsibility for possible errors in catalogs, brochures, and other printed material. Secop reserves the right to alter its products without notice. This also applies to products already on order provided that such alterations can be made without subsequent changes being necessary to specifications already agreed. All trademarks in this material are the property of the respective companies. Secop and the Secop logotype are trademarks of Secop GmbH. All rights reserved.

Model

Designation	HTK80AA	220-240V/50Hz 1~	Sales code:	16068300
-------------	----------------	-------------------------	-------------	-----------------

Compressor design

Oil type	Mineral	Refrigerant(s)	R600a
Oil viscosity	5cST	Displacement	8,1cm ³ / 0,49cu.in
Oil quantity	162cm ³ / 5,5fl.oz	Compressors on pallet	100
Refr. charge - tech. limit	150g / 5,3oz		
Free gas volume comp.	1500cm ³ / 50,7fl.oz		
Weight	7,9kg / 17,4lbs		
Motor protection	external		
Winding resistance main	25,8Ω (at 25°C)		
Winding resistance aux	16,3Ω (at 25°C)		
Max. winding temp.	130°C / 266°F		
Max. discharge temp.	130°C / 266°F		



General - Configurations with HTK80AA

	Conf. 1	Conf. 2
Motorconfiguration	RSIR	RSCR
Power supply (nominal)	220-240V/50Hz	220-240V/50Hz
Number of phases	1	1
Voltage range	187-264V	187-264V
Approvals	VDE	VDE
Starting torque	LST	LST
Note	Various options of connectors are possible - please contact SECOP-Sales.	

Applications with HTK80AA

	Conf. 1	Conf. 2
Refrigerant	R600a	R600a
Application	LBP	LBP
System cooling	static	static
Hot gas defrost	-/-	-/-
Long interval pull down	-/-	-/-

Electrical data - Configurations with HTK80AA

	Conf. 1	Conf. 2
Starting device type	PTC	PTC
Run capacitor	-/-	3μF
Start capacitor	-/-	-/-
LRA (locked rotor amps / 4s/ U(N))		
RLA (rated load amps / 1s/ U(N))	-/-A	-/-A
Cut in current (U(N))		

Model

Designation	HTK80AA	220-240V/50Hz 1~	Sales code:	16068300
-------------	----------------	------------------	-------------	-----------------

Compressor dimensions

Housing	A Height	166mm / 6,54in
	B Height	159mm / 6,26in
	C Length shell	194mm / 7,64in
	D Length w. cover	238mm / 9,37in
	E Width	151mm / 5,94in

Connectors		Suction	Discharge	Process
		X	Y	Z
Diameter	[mm]	øi 6,1-6,2	øi 5,1-5,2	øo 5,92-6,08
	(i:inside, o:outside) [in]	øi 0,24-0,24	øi 0,2-0,2	øo 0,23-0,24
Material		copper	copper	copper
Horizontal angle	±2°	45°	13°	0°
Vertical angle	±2°	30°	40°	145°
Position l/h/w	[mm]	120/72/62	112/106/62	-140/136/70
	[in]	4,7/2,8/2,4	4,4/4,2/2,4	-5,5/5,4/2,8
Straight tube l.	[mm]	14	14	75
	[in]	0,5	0,5	3



Compressor fixation

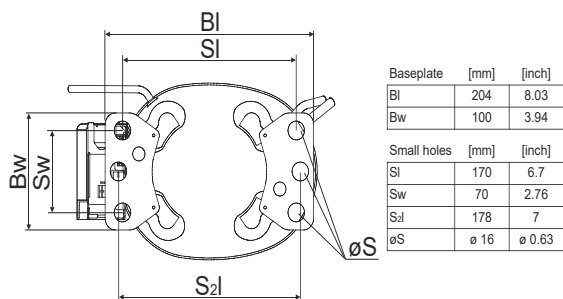

Bolt joint



Snap-on

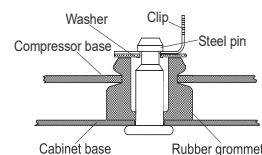

Mounting accessories

	order code
'4ZN' with rubber grommet	772N
'4ZN' with rubber grommet and sleeve for M6	768N
Bolt joint kit	4ZN + 118-1917 (18)
'4ZN' with Snap on kit	776N

Application notes

- Provision for PE Grounding is located at the PE Stamp on the compressor Housing with dip-tray fixture (omega bracket).
- Various options of connectors are possible - please contact SECOP-Sales.

Model

Designation	HTK80AA	220-240V/50Hz	Conf. 1	Sales code:	16068300
-------------	----------------	----------------------	---------	-------------	-----------------

Configuration

Motorconfiguration	RSIR
Power supply (nominal)	220-240V/50Hz 1~
Refrigerant	R600a
Application	LBP
Voltage range	187-264V
Starting torque	LST
Approvals	VDE

Electrical accessories / wiring diagram

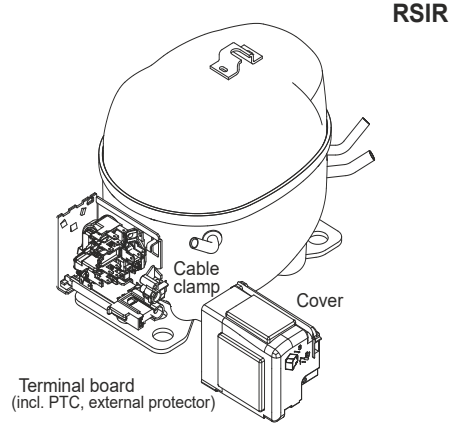

Ambient/ machine room temperatures minimum /maximum

Ambient temperature range:	10 - 43°C / 50 - 110°F
Machine room temperature range:	10 - 48°C / 50 - 119°F
Compressor cooling:	static

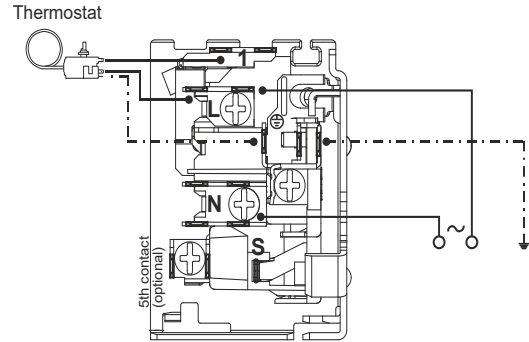

Operation pressure range

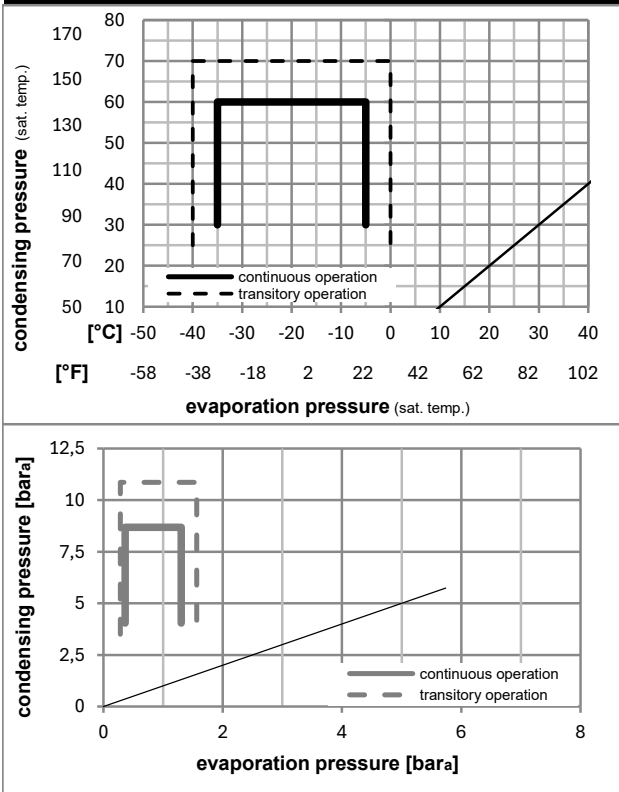

8858-6

Components

. terminal board (PTC, 4.8mm)	15164300
b cover terminal board	10636401
. cable clamp	11341000
. screw - uni6954	10636000
. screw - uni6954	10636200
. screw uni en iso 4757	10641201

Model

Designation	HTK80AA	220-240V/50Hz	Conf. 1	Sales code:	16068300
-------------	----------------	----------------------	---------	-------------	-----------------

Optimization + standard conditions

R600a, 220V/50Hz, RSIR, static, VDE

		Evaporating pressure (saturation temperature)				Condensing pressure (saturation temperature)			Return gas temp.		Liquid temp.		Cooling capacity			COP	EER	Power consumption		Current consumption		Ref. mass flow	
		pe	pc	RGT	Tliq	[W]	[Btu/h]	[kcal/h]	[W/W]	[Btu/Wh]	[kcal/Wh]	[W]	[A]	[kg/h]			P1	I	m				
[°C]	[°F]	[°C]	[°F]	[°C]	[°F]																		
-23	-10	54	130	32	90	136,1	465	117,2	1,61	5,50	1,39	84,5	0,53	1,46								ASHRAE LBP	
-25	-13	55	131	32	90	101,8	348	87,6	1,25	4,28	1,08	81,2	0,51	1,33								cecomaf LBP	
-35	-31	40	104	20	68	64,7	221	55,7	1,06	3,64	0,92	60,8	0,42	0,79								EN12900 LBP	
-23	-10	49	120	4,4	40	110,4	377	95,0	1,36	4,66	1,17	80,9	0,52	1,61								ARI540 LBP	
-23	-10	41	105	32	90	145,1	496	124,9	1,92	6,56	1,65	75,5	0,49	1,56								AHAM LBP	
-35	-31	45	113	32	90	62,9	215	54,1	1,03	3,51	0,88	61,3	0,42	0,75								opt	

Performance tables

R600a, 220V/50Hz, RSIR, static, VDE

	pe		Cooling capacity			COP	EER		P1	I	m
	[°C]	[°F]	[W]	[Btu/h]	[kcal/h]	[W/W]	[Btu/Wh]	[kcal/Wh]	[W]	[A]	[kg/h]
[°C / °F]	-35	-31	62,9	215	54,1	1,03	3,51	0,88	61,3	0,42	0,75
cond. pressure	-30	-22	87,5	299	75,3	1,28	4,39	1,11	68,1	0,46	1,04
pc= 45/113	-25	-13	117,3	400	100,9	1,55	5,29	1,33	75,7	0,49	1,40
return gas temp.	-23	-10	128,6	439	110,6	1,64	5,60	1,41	78,4	0,51	1,53
RGT= 32/90	-20	-4	152,1	520	130,9	1,82	6,21	1,56	83,7	0,53	1,81
liquid temp	-15	5	192,1	656	165,3	2,09	7,13	1,80	92,0	0,56	2,30
Tliq= 45/113	-5	23	287,1	981	247,1	2,64	9,02	2,27	108,7	0,64	3,45
[°C / °F]	-35	-31	54,9	188	47,3	0,90	3,07	0,77	61,1	0,39	0,71
cond. pressure	-30	-22	75,7	258	65,1	1,07	3,65	0,92	70,8	0,46	0,99
pc= 55/131	-25	-13	101,8	348	87,6	1,25	4,28	1,08	81,2	0,51	1,33
return gas temp	-23	-10	111,9	382	96,3	1,32	4,50	1,13	84,9	0,53	1,46
RGT= 32/90	-20	-4	133,3	455	114,7	1,44	4,93	1,24	92,2	0,56	1,74
liquid temp	-15	5	170,0	581	146,3	1,64	5,61	1,41	103,6	0,61	2,23
Tliq= 55/131	-5	23	259,4	886	223,2	2,05	7,00	1,76	126,6	0,70	3,41

Model

Designation	HTK80AA	220-240V/50Hz	Conf. 2	Sales code:	16068300
-------------	----------------	----------------------	----------------	-------------	-----------------

Configuration

Motorconfiguration	RSCR
Power supply (nominal)	220-240V/50Hz 1~
Refrigerant	R600a
Application	LBP
Voltage range	187-264V
Starting torque	LST
Approvals	VDE

Electrical accessories / wiring diagram

RSCR



Ambient/ machine room temperatures minimum /maximum

Ambient temperature range:	10 - 43°C / 50 - 110°F
Machine room temperature range:	10 - 48°C / 50 - 119°F
Compressor cooling:	static



Operation pressure range

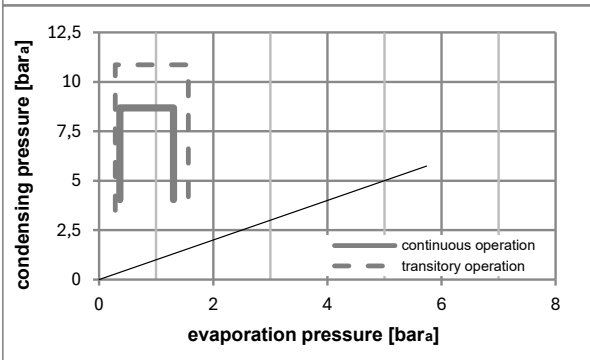
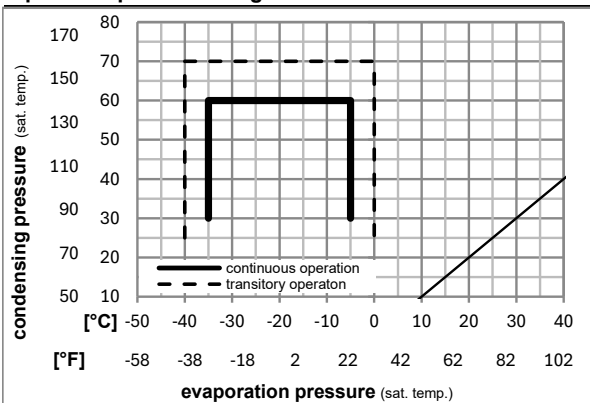

Components

. terminal board (PTC, 4.8mm)	15164300
. run capacitor (3μF, 4.8mm)	10692902
b cover terminal board	10636401
. cable clamp	11341000
. screw - uni6954	10636000
. screw - uni6954	10636200

Model

Designation	HTK80AA	220-240V/50Hz	Conf. 2	Sales code:	16068300
-------------	----------------	----------------------	----------------	-------------	-----------------

Optimization + standard conditions

R600a, 220V/50Hz, RSCR, static, VDE

		Evaporating pressure (saturation temperature)				Condensing pressure (saturation temperature)			Return gas temp.		Liquid temp.		Cooling capacity			COP	EER	Power consumption		Current consumption		Ref. mass flow	
		pe	pc	RGT	Tliq	[W]	[Btu/h]	[kcal/h]	[W/W]	[Btu/Wh]	[kcal/Wh]	[W]	[A]	[kg/h]			P1	I	m				
[°C]	[°F]	[°C]	[°F]	[°C]	[°C]																		
-23	-10	54	130	32	32	136,1	465	117,2	1,66	5,66	1,43	82,1	0,39	1,46								ASHRAE LBP	
-25	-13	55	131	32	55	101,8	348	87,6	1,29	4,41	1,11	78,9	0,38	1,33								cecomaf LBP	
-35	-31	40	104	20	40	64,7	221	55,7	1,09	3,73	0,94	59,2	0,32	0,79								EN12900 LBP	
-23	-10	49	120	4,4	49	110,4	377	95,0	1,40	4,79	1,21	78,6	0,39	1,61								ARI540 LBP	
-23	-10	41	105	32	32	145,1	496	124,9	1,97	6,72	1,69	73,7	0,38	1,56								AHAM LBP	
-35	-31	45	113	32	45	62,9	215	54,1	1,06	3,61	0,91	59,5	0,32	0,75								opt	

Performance tables

R600a, 220V/50Hz, RSCR, static, VDE

	pe		Cooling capacity			COP	EER		P1	I	m
	[°C]	[°F]	[W]	[Btu/h]	[kcal/h]	[W/W]	[Btu/Wh]	[kcal/Wh]	[W]	[A]	[kg/h]
[°C / °F]	-35	-31	62,9	215	54,1	1,06	3,61	0,91	59,5	0,32	0,75
cond. pressure	-30	-22	87,5	299	75,3	1,32	4,51	1,14	66,3	0,35	1,04
pc= 45/113	-25	-13	117,3	400	100,9	1,59	5,43	1,37	73,7	0,37	1,40
return gas temp.	-23	-10	128,6	439	110,6	1,68	5,75	1,45	76,3	0,38	1,53
RGT= 32/90	-20	-4	152,1	520	130,9	1,87	6,37	1,61	81,5	0,40	1,81
liquid temp	-15	5	192,1	656	165,3	2,14	7,32	1,84	89,7	0,43	2,30
Tliq= 45/113	-5	23	287,1	981	247,1	2,70	9,22	2,32	106,4	0,50	3,45
[°C / °F]	-35	-31	54,9	188	47,3	0,93	3,18	0,80	59,1	0,31	0,71
cond. pressure	-30	-22	75,7	258	65,1	1,10	3,76	0,95	68,7	0,34	0,99
pc= 55/131	-25	-13	101,8	348	87,6	1,29	4,41	1,11	78,9	0,38	1,33
return gas temp	-23	-10	111,9	382	96,3	1,36	4,63	1,17	82,5	0,39	1,46
RGT= 32/90	-20	-4	133,3	455	114,7	1,49	5,08	1,28	89,6	0,41	1,74
liquid temp	-15	5	170,0	581	146,3	1,69	5,76	1,45	100,8	0,45	2,23
Tliq= 55/131	-5	23	259,4	886	223,2	2,10	7,16	1,80	123,7	0,53	3,41



K-Series Compressors

GTK, HKK, HMK, HTK, HXK, HZK



Service/Repair – R600a

8845-2



K-Series Compressors

GTK, HKK, HMK, HTK, HXK, HZK



Service/Repair – R600a

Secop accepts no responsibility for possible errors in catalogs, brochures, and other printed material. Secop reserves the right to alter its products without notice. This also applies to products already on order provided that such alterations can be made without subsequential changes being necessary to specifications already agreed. All trademarks in this material are the property of the respective companies. Secop and the Secop logotype are trademarks of Secop GmbH. All rights reserved. www.secop.com