

Single Pack HXK12AT 200-240V 50Hz / 208-230V 60Hz RSIR

Single pack code number: **195B4620**

Position	Title	Code	Amount
1	Compressor HXK12AT	16470500	1
2	Clip	10633900	4
3	Steel pin	10634100	4
4	Washer	10634300	4
5	Screw for cable clamp	10636000	1
6	Screw for cable clamp	10636200	1
7	Cover	10636401	1
8	Earth screw	10641201	1
9	Rubber grommet 16mm	11322600	4
10	Cable clamp	11341000	1
11	Terminal board 6.3mm	16425700	1

Secop GmbH • Lise-Meitner-Straße 29 • 24941 Flensburg, Germany • Tel: +49 461 4941 0 • www.secop.com

Secop accepts no responsibility for possible errors in catalogs, brochures, and other printed material. Secop reserves the right to alter its products without notice. This also applies to products already on order provided that such alterations can be made without subsequent changes being necessary to specifications already agreed. All trademarks in this material are the property of the respective companies. Secop and the Secop logotype are trademarks of Secop GmbH. All rights reserved.

Model

Designation	HXK12AT	200-240V/50Hz 1~ 208-230V/60Hz 1~	Sales code:	16470500
-------------	----------------	-----------------------------------	-------------	-----------------

Compressor design

Oil type	Mineral	Refrigerant(s)	R600a
Oil viscosity	5cST	Displacement	11,1cm ³ / 0,68cu.in
Oil quantity	162cm ³ / 5,5fl.oz	Compressors on pallet	100
Refr. charge - tech. limit	150g / 5,3oz		
Free gas volume comp.	1560cm ³ / 52,7fl.oz		
Weight	8,9kg / 19,6lbs		
Motor protection	external		
Winding resistance main	12,4Ω (at 25°C)		
Winding resistance aux	15,3Ω (at 25°C)		
Max. winding temp.	130°C / 266°F		
Max. discharge temp.	130°C / 266°F		



General - Configurations with HXK12AT

	Conf. 1	Conf. 2	Conf. 3
Motorconfiguration	RSIR	RSCR	RSCR
Power supply (nominal)	200-240V/50Hz	200-240V/50Hz	208-230V/60Hz
Number of phases	1	1	1
Voltage range	170-264V	170-264V	198-253V
Approvals	VDE	VDE	VDE
Starting torque	LST	LST	LST
Note	Various options of connectors are possible - please contact SECOP-Sales.		

Applications with HXK12AT

	Conf. 1	Conf. 2	Conf. 3
Refrigerant	R600a	R600a	R600a
Application	LBP	LBP	LBP
System cooling	static	static	static
Hot gas defrost	-/-	-/-	-/-
Long interval pull down	-/-	-/-	-/-

Electrical data - Configurations with HXK12AT

	Conf. 1	Conf. 2	Conf. 3
Starting device type	PTC	PTC	PTC
Run capacitor	-/-	4μF	4μF
Start capacitor	-/-	-/-	-/-
LRA (locked rotor amps / 4s/ U(N))	8,2A	8,2A	
RLA (rated load amps / 1s/ U(N))			
Cut in current (U(N))	16,4A	16,4A	

Model

Designation **HXK12AT** 200-240V/50Hz 1~ 208-230V/60Hz 1~ Sales code: **16470500**

Compressor dimensions

Housing	A Height	174mm / 6,85in
	B Height	167mm / 6,57in
	C Length shell	194mm / 7,64in
	D Length w. cover	238mm / 9,37in
	E Width	151mm / 5,94in

Connectors		Suction	Discharge	Process
		X	Y	Z
Diameter	[mm]	øi 6,1-6,2	øi 5,1-5,2	øo 5,92-6,08
	(i:inside, o:outside) [in]	øi 0,24-0,24	øi 0,2-0,2	øo 0,23-0,24
Material		copper	copper	copper
Horizontal angle	±2°	45°	13°	0°
Vertical angle	±2°	30°	40°	145°
Position l/h/w	[mm]	120/72/62	112/106/62	-140/136/70
	[in]	4,7/2,8/2,4	4,4/4,2/2,4	-5,5/5,4/2,8
Straight tube l.	[mm]	14	14	75
	[in]	0,5	0,5	3



Compressor fixation

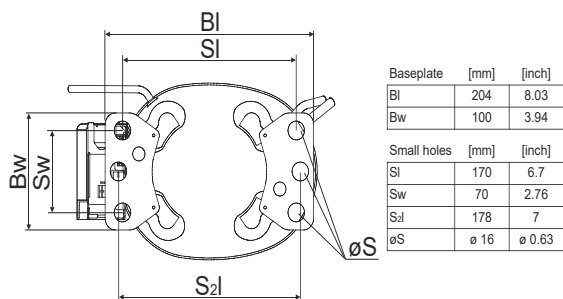

Bolt joint



Snap-on

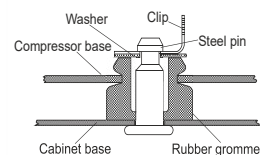

Mounting accessories

'4ZN' with rubber grommet	order code	772N
'4ZN' with rubber grommet and sleeve for M6		768N
Bolt joint kit		4ZN + 118-1917 (18)
'4ZN' with Snap on kit		776N

Application notes

Provision for PE Grounding is located at the PE Stamp on the compressor Housing with dip-tray fixture (omega bracket).
 Various options of connectors are possible - please contact SECOP-Sales.

Model

Designation	HXK12AT	200-240V/50Hz	Conf. 1	Sales code:	16470500
-------------	----------------	----------------------	---------	-------------	-----------------

Configuration

Motorconfiguration	RSIR
Power supply (nominal)	200-240V/50Hz 1~
Refrigerant	R600a
Application	LBP
Voltage range	170-264V
Starting torque	LST
Approvals	VDE

Electrical accessories / wiring diagram

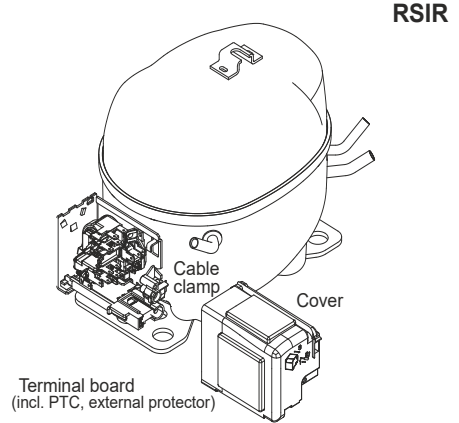

Ambient/ machine room temperatures minimum /maximum

Ambient temperature range:	10 - 43°C / 50 - 110°F
Machine room temperature range:	10 - 48°C / 50 - 119°F
Compressor cooling:	static

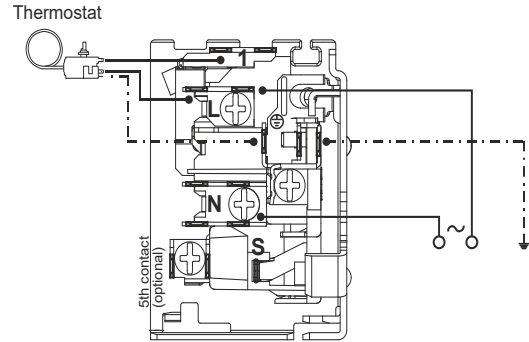

Operation pressure range

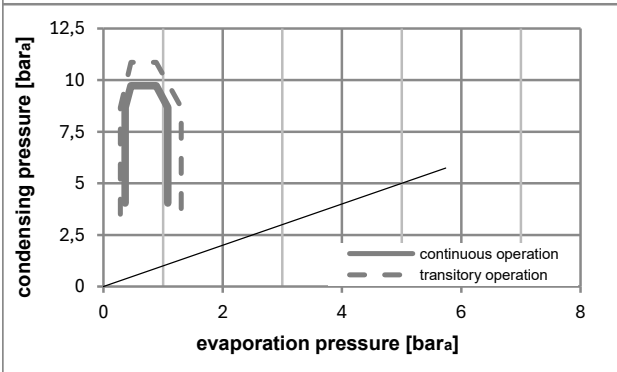
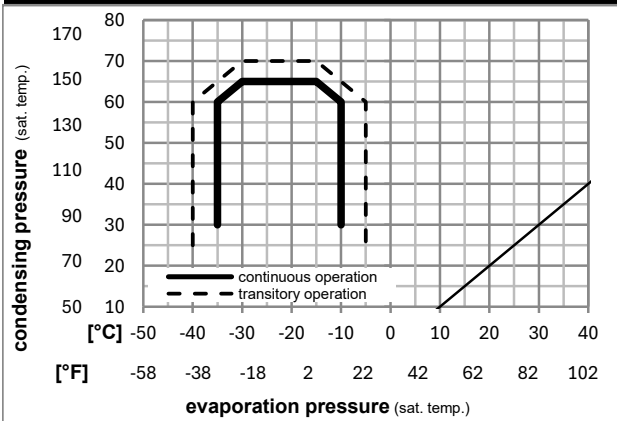

Components

. terminal board (PTC, 4.8mm)	16425900
b cover terminal board	10636401
. cable clamp	11341000
. screw - uni6954	10636000
. screw - uni6954	10636200
. screw uni en iso 4757	10641201

Alternative components

. terminal board (PTC, 6.3mm)	16425700
-------------------------------	----------

Model

Designation	HXK12AT	200-240V/50Hz	Conf. 1	Sales code:	16470500
-------------	----------------	----------------------	---------	-------------	-----------------

Optimization + standard conditions

R600a, 200V/50Hz, RSIR, static, VDE

		Evaporating pressure (saturation temperature)				Condensing pressure (saturation temperature)			Return gas temp.		Liquid temp.		Cooling capacity			COP	EER	Power consumption		Current consumption		Ref. mass flow	
		pe	pc	RGT	Tliq	[W]	[Btu/h]	[kcal/h]	[W/W]	[Btu/Wh]	[kcal/Wh]	[W]	[A]	[kg/h]			P1	I	m				
[°C]	[°F]	[°C]	[°F]	[°C]	[°C]																		
-23	-10	54	130	32	32	198,1	677	170,5	1,67	5,70	1,44	118,7	0,63	2,13								ASHRAE LBP	
-25	-13	55	131	32	55	149,8	511	128,9	1,30	4,43	1,12	115,4	0,61	1,95								cecomaf LBP	
-35	-31	40	104	20	40	113,6	388	97,8	1,20	4,10	1,03	94,6	0,55	1,38								EN12900 LBP	
-23	-10	49	120	4,4	49	160,1	547	137,8	1,40	4,80	1,21	114,0	0,61	2,34								ARI540 LBP	
-23	-10	41	105	32	32	208,0	710	179,0	1,93	6,59	1,66	107,7	0,60	2,23								AHAM LBP	
-35	-31	45	113	32	45	110,5	377	95,1	1,13	3,87	0,98	97,5	0,55	1,31								opt	

Performance tables

R600a, 200V/50Hz, RSIR, static, VDE

	pe		Cooling capacity			COP	EER	P1	I	m	
	[°C]	[°F]	[W]	[Btu/h]	[kcal/h]	[W/W]	[Btu/Wh]	[kcal/Wh]	[W]	[A]	[kg/h]
[°C / °F]	-35	-31	110,5	377	95,1	1,13	3,87	0,98	97,5	0,55	1,31
cond. pressure	-30	-22	135,5	463	116,6	1,35	4,61	1,16	100,5	0,56	1,61
pc= 45/113	-25	-13	171,1	584	147,2	1,59	5,43	1,37	107,6	0,59	2,04
return gas temp.	-23	-10	185,6	634	159,7	1,67	5,72	1,44	110,9	0,61	2,21
RGT= 32/90	-20	-4	217,2	742	187,0	1,83	6,26	1,58	118,5	0,64	2,59
liquid temp	-15	5	273,9	936	235,8	2,06	7,05	1,78	132,7	0,70	3,27
Tliq= 45/113	-10	14	341,2	1165	293,7	2,28	7,77	1,96	149,9	0,77	4,09
[°C / °F]	-35	-31	94,1	321	81,0	0,91	3,12	0,79	102,9	0,57	1,22
cond. pressure	-30	-22	117,4	401	101,0	1,10	3,75	0,94	107,0	0,58	1,53
pc= 55/131	-25	-13	149,8	511	128,9	1,30	4,43	1,12	115,4	0,61	1,95
return gas temp	-23	-10	162,8	556	140,1	1,37	4,66	1,18	119,2	0,63	2,13
RGT= 32/90	-20	-4	191,2	653	164,6	1,50	5,11	1,29	127,8	0,66	2,50
liquid temp	-15	5	241,8	826	208,1	1,68	5,74	1,45	143,7	0,73	3,17
Tliq= 55/131	-10	14	301,4	1029	259,4	1,85	6,32	1,59	162,9	0,82	3,96

Model

Designation	HXK12AT	200-240V/50Hz	Conf. 2	Sales code:	16470500
-------------	----------------	----------------------	----------------	-------------	-----------------

Configuration

Motorconfiguration	RSCR
Power supply (nominal)	200-240V/50Hz 1~
Refrigerant	R600a
Application	LBP
Voltage range	170-264V
Starting torque	LST
Approvals	VDE

Electrical accessories / wiring diagram

RSCR

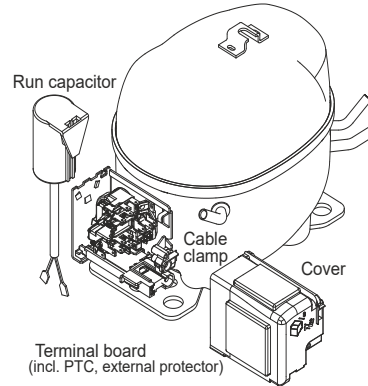

Ambient/ machine room temperatures minimum /maximum

Ambient temperature range:	10 - 43°C / 50 - 110°F
Machine room temperature range:	10 - 48°C / 50 - 119°F
Compressor cooling:	static

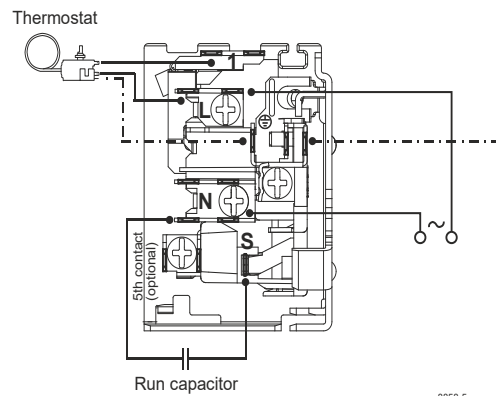

8858-5

Operation pressure range

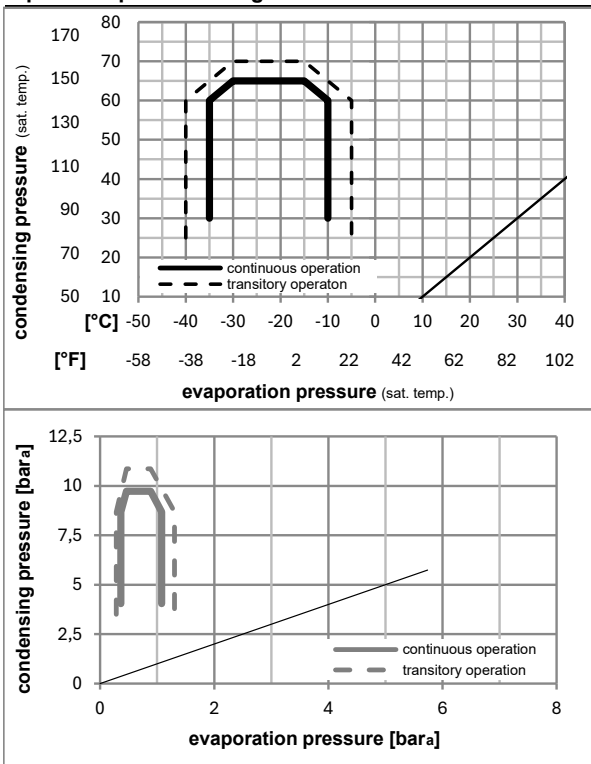

Components

. terminal board (PTC, 4.8mm)	16425900
. run capacitor (4µF, 4.8mm)	10693001
b cover terminal board	10636401
. cable clamp	11341000
. screw - uni6954	10636000
. screw - uni6954	10636200

Alternative components

. terminal board (PTC, 6.3mm)	16425700
. run capacitor (4µF, 4.8mm)	16344500
. run capacitor (4µF, 6.3mm)	15186801
. screw uni en iso 4757	10641201

Model

Designation	HXK12AT	200-240V/50Hz	Conf. 2	Sales code:	16470500
-------------	----------------	----------------------	----------------	-------------	-----------------

Optimization + standard conditions

R600a, 200V/50Hz, RSCR, static, VDE

		Evaporating pressure (saturation temperature)				Condensing pressure (saturation temperature)			Return gas temp.		Liquid temp.		Cooling capacity			COP	EER	Power consumption		Current consumption		Ref. mass flow	
		pe	pc	RGT	Tliq	[W]	[Btu/h]	[kcal/h]	[W/W]	[Btu/W/h]	[kcal/Wh]	[W]	[A]	[W]	[A]	[kg/h]							
[°C]	[°F]	[°C]	[°F]	[°C]	[°C]																		
-23	-10	54	130	32	32	200,1	683	172,2	1,73	5,92	1,49	115,5	0,60	2,15								ASHRAE LBP	
-25	-13	55	131	32	55	151,3	517	130,2	1,35	4,60	1,16	112,3	0,59	1,97								cecomaf LBP	
-35	-31	40	104	20	40	114,8	392	98,8	1,25	4,26	1,07	92,1	0,53	1,40								EN12900 LBP	
-23	-10	49	120	4,4	49	161,7	552	139,2	1,46	4,98	1,25	110,9	0,59	2,36								ARI540 LBP	
-23	-10	41	105	32	32	210,1	717	180,8	2,00	6,84	1,72	104,8	0,57	2,25								AHAM LBP	
-35	-31	45	113	32	45	111,6	381	96,1	1,18	4,02	1,01	94,8	0,53	1,33								opt	

Performance tables

R600a, 200V/50Hz, RSCR, static, VDE

	pe		Cooling capacity			COP	EER		P1	I	m
	[°C]	[°F]	[W]	[Btu/h]	[kcal/h]	[W/W]	[Btu/W/h]	[kcal/Wh]	[W]	[A]	[kg/h]
[°C / °F]	-35	-31	111,6	381	96,1	1,18	4,02	1,01	94,8	0,53	1,33
cond. pressure	-30	-22	136,9	467	117,8	1,40	4,78	1,21	97,7	0,54	1,63
pc= 45/113	-25	-13	172,8	590	148,7	1,65	5,64	1,42	104,7	0,57	2,06
return gas temp.	-23	-10	187,5	640	161,3	1,74	5,93	1,50	107,9	0,58	2,23
RGT= 32/90	-20	-4	219,4	749	188,8	1,90	6,50	1,64	115,3	0,61	2,62
liquid temp	-15	5	276,7	945	238,1	2,14	7,32	1,84	129,1	0,67	3,31
Tliq= 45/113	-10	14	344,6	1177	296,6	2,36	8,07	2,03	145,9	0,74	4,13
[°C / °F]	-35	-31	95,0	325	81,8	0,95	3,24	0,82	100,2	0,55	1,24
cond. pressure	-30	-22	118,6	405	102,0	1,14	3,89	0,98	104,1	0,56	1,54
pc= 55/131	-25	-13	151,3	517	130,2	1,35	4,60	1,16	112,3	0,59	1,97
return gas temp	-23	-10	164,5	562	141,5	1,42	4,84	1,22	116,0	0,61	2,15
RGT= 32/90	-20	-4	193,1	660	166,2	1,55	5,30	1,34	124,4	0,64	2,52
liquid temp	-15	5	244,2	834	210,1	1,75	5,96	1,50	139,9	0,71	3,20
Tliq= 55/131	-10	14	304,4	1040	262,0	1,92	6,56	1,65	158,5	0,79	4,00

Model

Designation	HXK12AT	208-230V/60Hz	Conf. 3	Sales code:	16470500
-------------	----------------	----------------------	----------------	-------------	-----------------

Configuration

Motorconfiguration	RSCR
Power supply (nominal)	208-230V/60Hz 1~
Refrigerant	R600a
Application	LBP
Voltage range	198-253V
Starting torque	LST
Approvals	VDE

Electrical accessories / wiring diagram

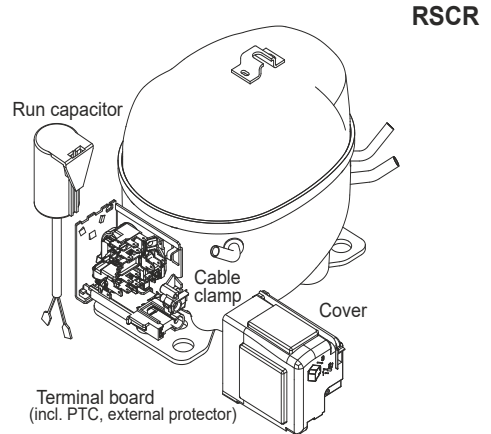

Ambient/ machine room temperatures minimum /maximum

Ambient temperature range:	10 - 43°C / 50 - 110°F
Machine room temperature range:	10 - 48°C / 50 - 119°F
Compressor cooling:	static

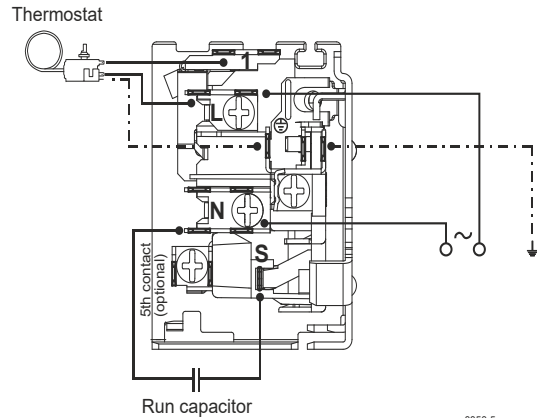

Operation pressure range

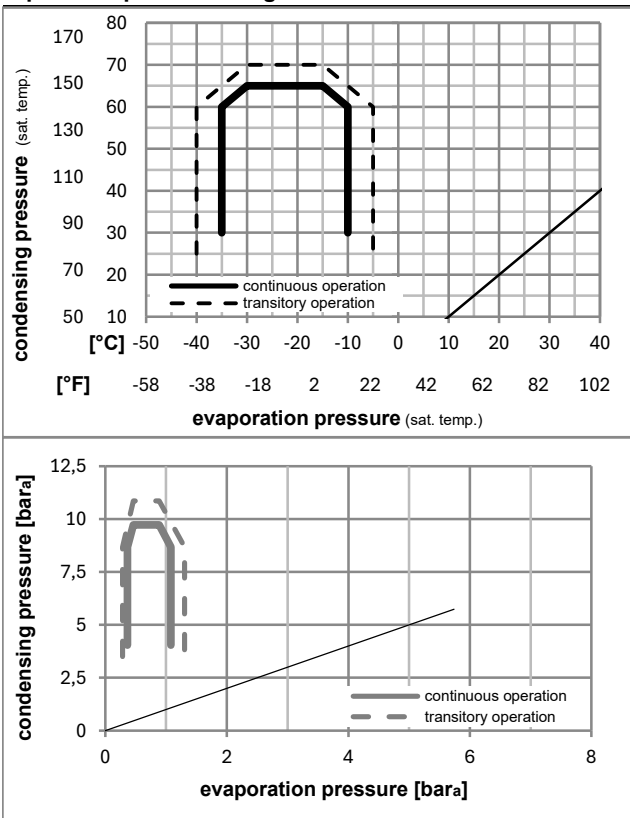

Components

. terminal board (PTC, 4.8mm)	16425900
. run capacitor (4μF, 4.8mm)	10693001
b cover terminal board	10636401
. cable clamp	11341000
. screw - uni6954	10636000
. screw - uni6954	10636200

Alternative components

. terminal board (PTC, 6.3mm)	16425700
. run capacitor (4μF, 4.8mm)	16344500
. run capacitor (4μF, 6.3mm)	15186801
. screw uni en iso 4757	10641201

Model

Designation **HXK12AT** **208-230V/60Hz** Conf. 3 Sales code: **16470500**

Optimization + standard conditions

R600a, 220V/60Hz, RSCR, static, VDE

		Evaporating pressure (saturation temperature)				Condensing pressure (saturation temperature)			Return gas temp.		Liquid temp.		Cooling capacity			COP	EER	Power consumption		
		pe	pc	RGT	Tliq	[W]	[Btu/h]	[kcal/h]	[W/W]	[Btu/Wh]	[kcal/Wh]	[W]	I	Ref. mass flow						
[°C]	[°F]	[°C]	[°F]	[°C]	[°F]							[A]	[kg/h]							
-23	-10	54	130	32	90	235,6	805	202,8	1,75	5,97	1,50	134,8	0,71	2,53	ASHRAE LBP					
-25	-13	55	131	32	90	178,2	608	153,3	1,36	4,64	1,17	131,1	0,70	2,32	cecomaf LBP					
-35	-31	40	104	20	68	134,1	458	115,4	1,25	4,27	1,08	107,2	0,62	1,63	EN12900 LBP					
-23	-10	49	120	4,4	40	189,8	648	163,3	1,47	5,01	1,26	129,4	0,70	2,77	ARI540 LBP					
-23	-10	41	105	32	90	245,3	838	211,1	2,01	6,85	1,73	122,2	0,68	2,63	AHAM LBP					
-35	-31	45	113	32	90	131,0	447	112,7	1,19	4,05	1,02	110,5	0,63	1,56	opt					

Performance tables

R600a, 220V/60Hz, RSCR, static, VDE

	pe		Cooling capacity			COP	EER		P1	I	m
	[°C]	[°F]	[W]	[Btu/h]	[kcal/h]	[W/W]	[Btu/Wh]	[kcal/Wh]	[W]	[A]	[kg/h]
[°C / °F]	-35	-31	131,0	447	112,7	1,19	4,05	1,02	110,5	0,63	1,56
cond. pressure	-30	-22	160,3	547	137,9	1,41	4,81	1,21	113,9	0,64	1,91
pc= 45/113	-25	-13	202,2	690	174,0	1,66	5,66	1,43	122,1	0,67	2,41
return gas temp.	-23	-10	219,3	749	188,7	1,74	5,95	1,50	125,8	0,69	2,61
RGT= 32/90	-20	-4	256,6	876	220,9	1,91	6,51	1,64	134,6	0,72	3,06
liquid temp	-15	5	323,7	1105	278,5	2,14	7,32	1,84	151,0	0,79	3,87
Tliq= 45/113	-10	14	403,2	1377	347,0	2,36	8,05	2,03	171,0	0,88	4,83
[°C / °F]	-35	-31	112,3	383	96,6	0,96	3,28	0,83	116,8	0,65	1,46
cond. pressure	-30	-22	139,8	477	120,3	1,15	3,93	0,99	121,4	0,66	1,82
pc= 55/131	-25	-13	178,2	608	153,3	1,36	4,64	1,17	131,1	0,70	2,32
return gas temp	-23	-10	193,7	661	166,7	1,43	4,88	1,23	135,5	0,71	2,53
RGT= 32/90	-20	-4	227,4	777	195,7	1,56	5,34	1,35	145,4	0,76	2,97
liquid temp	-15	5	287,6	982	247,5	1,76	5,99	1,51	163,8	0,84	3,77
Tliq= 55/131	-10	14	358,6	1225	308,6	1,93	6,58	1,66	186,0	0,93	4,71

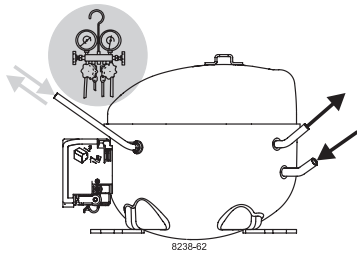

K-Series Compressors

GTK, HKK, HMK, HTK, HXK, HZK

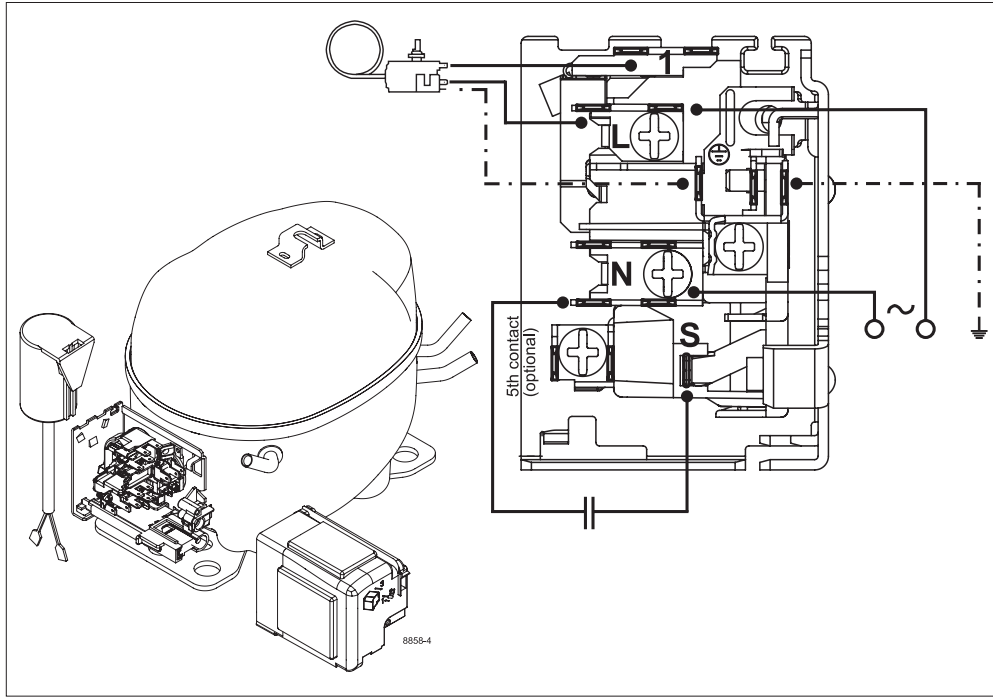

Service/Repair – R600a

8545-2

R600a

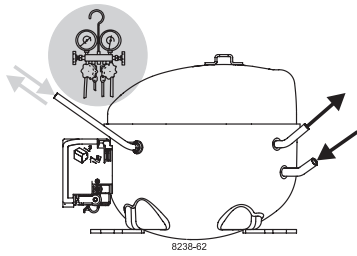

K-Series Compressors

GTK, HKK, HMK, HTK, HXK, HZK

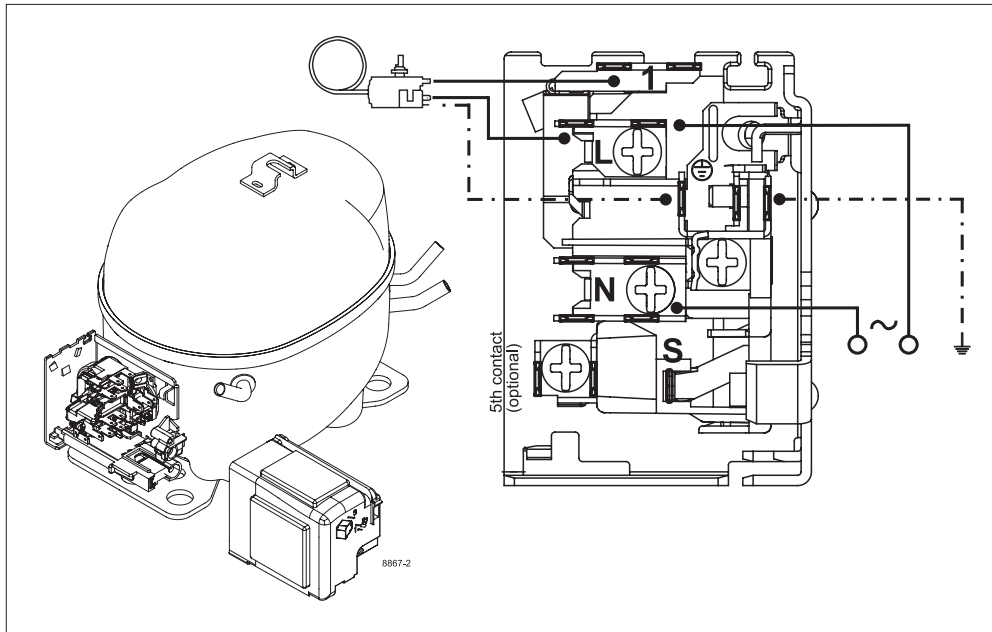

Service/Repair – R600a

Secop accepts no responsibility for possible errors in catalogs, brochures, and other printed material. Secop reserves the right to alter its products without notice. This also applies to products already on order provided that such alterations can be made without subsequential changes being necessary to specifications already agreed. All trademarks in this material are the property of the respective companies. Secop and the Secop logotype are trademarks of Secop GmbH. All rights reserved. www.secop.com