

## Single Pack NLE8.8CN 115-127V 60Hz RSCR

Single pack code number: **195B4723**

Position	Title	Code	Amount
1	Compressor NLE8.8CN	105H6094	1
2	e-PTC starting device (115V, 50hm, 6.3mm)	103N0058	1
3	Run capacitor holder	117-0300	1
4	Screw for bracket M4x8mm	117-0301	1
5	Run capacitor (23.5µF 190V, 6.3mm)	117-7114	1
6	Cord relief	103N1010	1
7	Cover	103N2011	1
8	Bolt joint for one compressor   M6   ø16mm	118-1917	1

**Secop GmbH** • Lise-Meitner-Straße 29 • 24941 Flensburg, Germany • Tel: +49 461 4941 0 • [www.secop.com](http://www.secop.com)

Secop accepts no responsibility for possible errors in catalogs, brochures, and other printed material. Secop reserves the right to alter its products without notice. This also applies to products already on order provided that such alterations can be made without subsequent changes being necessary to specifications already agreed. All trademarks in this material are the property of the respective companies. Secop and the Secop logotype are trademarks of Secop GmbH. All rights reserved.

## Model

Designation	<b>NLE8.8CN</b>	115-127V/60Hz 1~	Sales code:	<b>105H6094</b>
-------------	-----------------	------------------	-------------	-----------------

## Compressor design

Oil type	Polyolester	Refrigerant(s)	<b>R290</b>
Oil viscosity	19,2cST	Displacement	8,76cm <sup>3</sup> / 0,53cu.in
Oil quantity	265cm <sup>3</sup> / 9fl.oz	Compressors on pallet	80
Refr. charge - tech. limit	400g / 14,1oz		
Free gas volume comp.	2360cm <sup>3</sup> / 79,8fl.oz		
Weight	10,9kg / 24lbs		
Motor protection	1# internal		
Winding resistance main	1,6Ω (at 25°C)		
Winding resistance aux	5,1Ω (at 25°C)		
Max. winding temp.	125°C / 257°F		
Max. discharge temp.	120°C / 248°F		



## General - Configurations with NLE8.8CN

	<b>Conf. 1</b>	<b>Conf. 2</b>	<b>Conf. 3</b>
Motorconfiguration	CSIR	RSIR	RSCR
Power supply (nominal)	115V/60Hz	115V/60Hz	115V/60Hz
Number of phases	1	1	1
Voltage range	95-135V	95-135V	95-135V
Approvals	UL, CCC	UL, CCC	UL, CCC
Starting torque	HST	LST	LST
Note	- / -		

## Applications with NLE8.8CN

	<b>Conf. 1</b>	<b>Conf. 2</b>	<b>Conf. 3</b>
Refrigerant	R290	R290	R290
Application	LBP+MBP	LBP+MBP	LBP+MBP
System cooling	fan 3m/s	fan 3m/s	fan 3m/s
Hot gas defrost	OK	OK	OK
Long interval pull down	OK	OK	OK

## Electrical data - Configurations with NLE8.8CN

	<b>Conf. 1</b>	<b>Conf. 2</b>	<b>Conf. 3</b>
Starting device type	relay	PTC	PTC
Run capacitor	-/-	-/-	23,5μF
Start capacitor	280μF	-/-	-/-
LRA (locked rotor amps / 4s)	32,01A	27,36A	27,36A
RLA (rated load amps / 1s)	5,33A	5,33A	5,33A
Cut in current	32,01A	32,5A	32,53A

## Model

Designation

**NLE8.8CN**

115-127V/60Hz 1~

Sales code:

**105H6094**

## Compressor dimensions

Housing	A Height	203mm / 7,99in
	B Height	197mm / 7,76in
	C Length shell	205mm / 8,07in
	D Length w. cover	254mm / 10in
	E Width	166mm / 6,54in

Connectors		Suction	Discharge	Process
		X	Y	Z
Diameter	[mm]	øi 8,11-8,29	øi 6,41-6,59	øi 6,41-6,59
	(i:inside, o:outside) [in]	øi 0,32-0,33	øi 0,25-0,26	øi 0,25-0,26
Material		copper	copper	copper
Horizontal angle	±2°	0°	0°	0°
Vertical angle	±2°	15°	21°	155°
Position l/h/w	[mm]	132/69/57	94/102/81	-109/94/72
	[in]	5,2/2,7/2,2	3,7/4/3,2	-4,3/3,7/2,8
Straight tube l.	[mm]	12	12	12
	[in]	0,5	0,5	0,5



## Compressor fixation



### Bolt joint

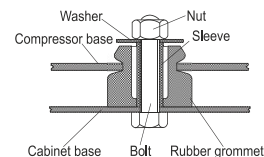

### Snap-on



## Mounting accessories

	one comp.	multi pack
Bolt joint   M6   ø16mm	118-1917	118-1918
Bolt joint   ø1/4"   ø16mm	118-1946	
Bolt joint   ø1/4"   ø19mm	118-1949	
Snap-on   ø7,3   ø16mm	118-1947	118-1919

## Application notes

LRA value on compressor label and datasheet may differ due to different test conditions for UL approval.

Provision for PE Grounding is located at the PE Stamp on the compressor

### Model

Designation	<b>NLE8.8CN</b>	<b>115V/60Hz</b>	<b>Conf. 1</b>	Sales code:	<b>105H6094</b>
-------------	-----------------	------------------	----------------	-------------	-----------------

### Configuration

Motorconfiguration	CSIR	
Power supply (nominal)	115V/60Hz 1~	
Refrigerant	R290	
Application	LBP+MBP	
Voltage range	95-135V	
Starting torque	HST	
Approvals	UL	SA3693
	CCC	

### Electrical accessories / wiring diagram



### Ambient/ machine room temperatures minimum /maximum

Ambient temperature range: 10 - 43°C / 50 - 110°F

Machine room temperature range: 10 - 48°C / 50 - 119°F

Compressor cooling: fan 3m/s

### Operation pressure range

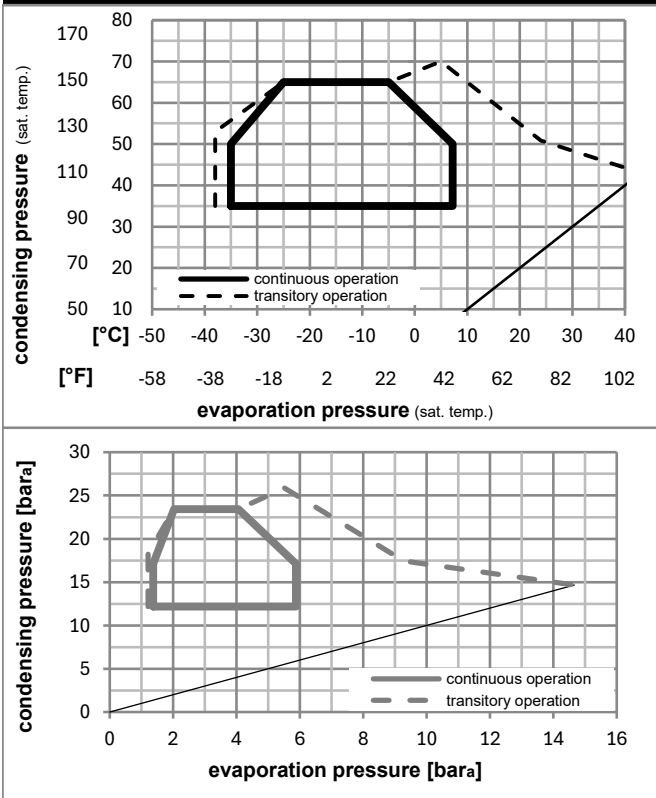

### Components

a2	current relay	117U7014
c	start capacitor (280µF)	117U5025
b	plastic cover	103N2011
d	cord relief	103N1010

### Model

Designation **NLE8.8CN** **115V/60Hz** Conf. 1 Sales code: **105H6094**

### Optimization + standard conditions

R290, 115V/60Hz, CSIR, fan 3m/s, UL, CCC

	Evaporating pressure (saturation temperature)				Cooling capacity			COP	EER	P1	Power consumption		ASHRAE LBP	
	pe	pc	RGT	Tliq	[W]	[Btu/h]	[kcal/h]				I	m		
[°C]	-23	54	32	32	512,6	1751	441,2	1,57	5,37	1,35	325,8	4,24	5,19	
[°F]	-10	130	90	90										
[°C]	-25	55	32	55	384,4	1313	330,8	1,22	4,16	1,05	315,7	4,18	4,79	cecomaf LBP
[°F]	-13	131	90	131										
[°C]	-35	40	20	40	304,3	1039	261,9	1,26	4,30	1,08	241,7	3,80	3,48	EN12900 LBP
[°F]	-31	104	68	104										
[°C]	-7	54	35	46	915,3	3126	787,7	2,08	7,11	1,79	439,5	5,00	10,44	ASHRAE MBP
[°F]	20	130	95	115										
[°C]	-10	55	32	55	728,1	2486	626,6	1,75	5,98	1,51	416,1	4,83	9,21	cecomaf MBP
[°F]	14	131	90	131										
[°C]	-10	45	20	45	807,7	2758	695,1	2,08	7,10	1,79	388,3	4,64	9,92	EN12900 MBP
[°F]	14	113	68	113										

### Performance tables

R290, 115V/60Hz, CSIR, fan 3m/s, UL, CCC

	pe		Cooling capacity			COP	EER		P1	I	m
	[°C]	[°F]	[W]	[Btu/h]	[kcal/h]		[Btu/Wh]	[kcal/Wh]			
[°C / °F]	-35	-31	288,9	987	248,6	1,18	4,02	1,01	245,5	3,83	3,24
cond. pressure	-23	-10	493,0	1684	424,3	1,60	5,46	1,37	308,7	4,15	5,57
pc= 45/113	-15	5	695,8	2376	598,8	1,95	6,68	1,68	356,0	4,43	7,92
return gas temp.	-9	15	858,1	2931	738,5	2,19	7,47	1,88	392,1	4,67	9,82
RGT= 32/90	-4	25	1042,6	3561	897,3	2,40	8,20	2,07	434,1	4,96	12,02
liquid temp	0	32	1185,3	4048	1020,1	2,53	8,65	2,18	468,0	5,20	13,75
Tliq= 45/113	7,2	45	1480,2	5055	1273,8	2,72	9,31	2,34	543,2	5,74	17,39
[°C / °F]	-35	-31	239,4	818	206,0	0,97	3,32	0,84	246,6	3,83	2,96
cond. pressure	-23	-10	415,0	1417	357,2	1,27	4,34	1,09	326,6	4,24	5,17
pc= 55/131	-15	5	596,3	2036	513,2	1,56	5,34	1,35	381,3	4,59	7,50
return gas temp	-9	15	743,8	2540	640,1	1,77	6,05	1,52	420,2	4,86	9,42
RGT= 32/90	-4	25	913,1	3118	785,8	1,97	6,73	1,70	463,2	5,19	11,65
liquid temp	0	32	1044,9	3568	899,2	2,10	7,18	1,81	496,7	5,45	13,42
Tliq= 55/131	7,2	45	1319,0	4505	1135,2	2,32	7,92	2,00	569,0	6,04	17,18

## Model

Designation	<b>NLE8.8CN</b>	<b>115V/60Hz</b>	<b>Conf. 2</b>	Sales code:	<b>105H6094</b>
-------------	-----------------	------------------	----------------	-------------	-----------------

## Configuration

Motorconfiguration	RSIR	
Power supply (nominal)	115V/60Hz 1~	
Refrigerant	R290	
Application	LBP+MBP	
Voltage range	95-135V	
Starting torque	LST	
Approvals	UL	SA3693
	CCC	

## Electrical accessories / wiring diagram

RSIR



## Ambient/ machine room temperatures minimum /maximum

Ambient temperature range: 10 - 43°C / 50 - 110°F

Machine room temperature range: 10 - 48°C / 50 - 119°F

Compressor cooling: fan 3m/s

## Operation pressure range

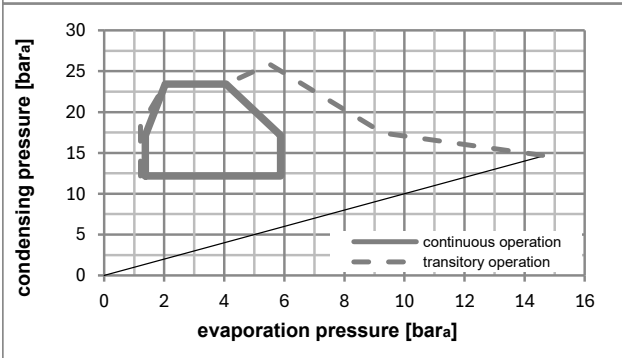
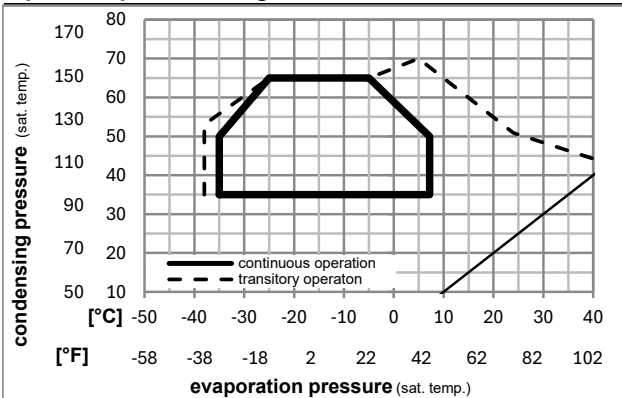

## Components

a1	e-PTC starter (115V, 50hm, 6.3mm, 4.8-cap)	103N0057
b	plastic cover	103N2011
d	cord relief	103N1010

## Alternative components

a1	e-PTC starter	103N0058
b	plastic cover	103N2011
d	cord relief	103N1010

### Model

Designation	<b>NLE8.8CN</b>	<b>115V/60Hz</b>	<b>Conf. 2</b>	Sales code:	<b>105H6094</b>
-------------	-----------------	------------------	----------------	-------------	-----------------

### Optimization + standard conditions

R290, 115V/60Hz, RSIR, fan 3m/s, UL, CCC

		Evaporating pressure (saturation temperature)				Cooling capacity			COP			EER			Power consumption			
		Condensing pressure (saturation temperature)		Return gas temp.		Liquid temp.					Current consumption			Ref. mass flow				
		pe	pc	RGT	Tliq	[W]	[Btu/h]	[kcal/h]	[W/W]	[Btu/Wh]	[kcal/Wh]	P1	I	m	[W]	[A]	[kg/h]	
[°C]	-23	54	32	32	512,6	1751	441,2	1,57	5,37	1,35	325,8	4,24	5,19	ASHRAE LBP				
[°F]	-10	130	90	90														
[°C]	-25	55	32	55	384,4	1313	330,8	1,22	4,16	1,05	315,7	4,18	4,79	cecomaf LBP				
[°F]	-13	131	90	131														
[°C]	-35	40	20	40	304,3	1039	261,9	1,26	4,30	1,08	241,7	3,80	3,48	EN12900 LBP				
[°F]	-31	104	68	104														
[°C]	-7	54	35	46	915,3	3126	787,7	2,08	7,11	1,79	439,5	5,00	10,44	ASHRAE MBP				
[°F]	20	130	95	115														
[°C]	-10	55	32	55	728,1	2486	626,6	1,75	5,98	1,51	416,1	4,83	9,21	cecomaf MBP				
[°F]	14	131	90	131														
[°C]	-10	45	20	45	807,7	2758	695,1	2,08	7,10	1,79	388,3	4,64	9,92	EN12900 MBP				
[°F]	14	113	68	113														

### Performance tables

R290, 115V/60Hz, RSIR, fan 3m/s, UL, CCC

	pe		Cooling capacity			COP			EER			P1	I	m
	[°C]	[°F]	[W]	[Btu/h]	[kcal/h]	[W/W]	[Btu/Wh]	[kcal/Wh]	[W]	[A]	[kg/h]			
[°C / °F]	-35	-31	288,9	987	248,6	1,18	4,02	1,01	245,5	3,83	3,24			
cond. pressure	-23	-10	493,0	1684	424,3	1,60	5,46	1,37	308,7	4,15	5,57			
pc= 45/113	-15	5	695,8	2376	598,8	1,95	6,68	1,68	356,0	4,43	7,92			
return gas temp.	-9	15	858,1	2931	738,5	2,19	7,47	1,88	392,1	4,67	9,82			
RGT= 32/90	-4	25	1042,6	3561	897,3	2,40	8,20	2,07	434,1	4,96	12,02			
liquid temp	0	32	1185,3	4048	1020,1	2,53	8,65	2,18	468,0	5,20	13,75			
Tliq= 45/113	7,2	45	1480,2	5055	1273,8	2,72	9,31	2,34	543,2	5,74	17,39			
[°C / °F]	-35	-31	239,4	818	206,0	0,97	3,32	0,84	246,6	3,83	2,96			
cond. pressure	-23	-10	415,0	1417	357,2	1,27	4,34	1,09	326,6	4,24	5,17			
pc= 55/131	-15	5	596,3	2036	513,2	1,56	5,34	1,35	381,3	4,59	7,50			
return gas temp	-9	15	743,8	2540	640,1	1,77	6,05	1,52	420,2	4,86	9,42			
RGT= 32/90	-4	25	913,1	3118	785,8	1,97	6,73	1,70	463,2	5,19	11,65			
liquid temp	0	32	1044,9	3568	899,2	2,10	7,18	1,81	496,7	5,45	13,42			
Tliq= 55/131	7,2	45	1319,0	4505	1135,2	2,32	7,92	2,00	569,0	6,04	17,18			

## Model

Designation	<b>NLE8.8CN</b>	<b>115V/60Hz</b>	<b>Conf. 3</b>	Sales code:	<b>105H6094</b>
-------------	-----------------	------------------	----------------	-------------	-----------------

## Configuration

Motorconfiguration	RSCR	
Power supply (nominal)	115V/60Hz 1~	
Refrigerant	R290	
Application	LBP+MBP	
Voltage range	95-135V	
Starting torque	LST	
Approvals	UL	SA3693
	CCC	

## Electrical accessories / wiring diagram

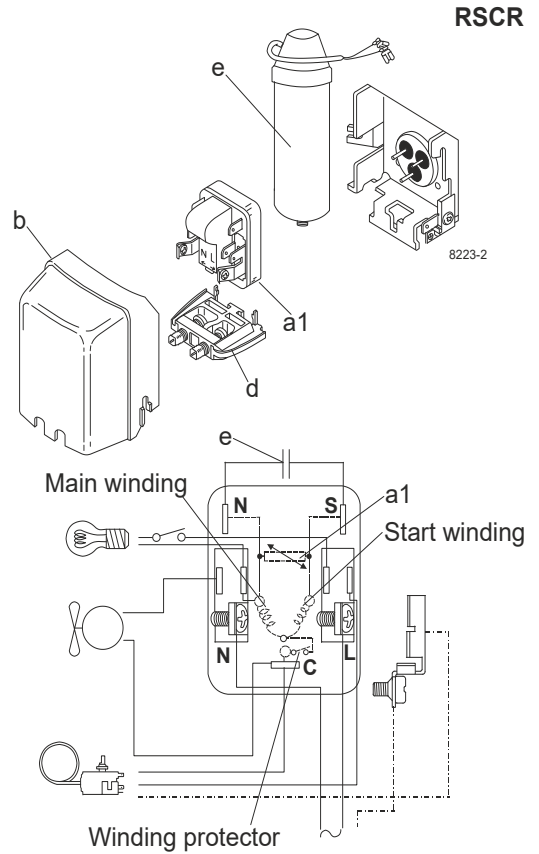

## Ambient/ machine room temperatures minimum /maximum

Ambient temperature range:	10 - 43°C / 50 - 110°F
Machine room temperature range:	10 - 48°C / 50 - 119°F
Compressor cooling:	fan 3m/s

## Operation pressure range

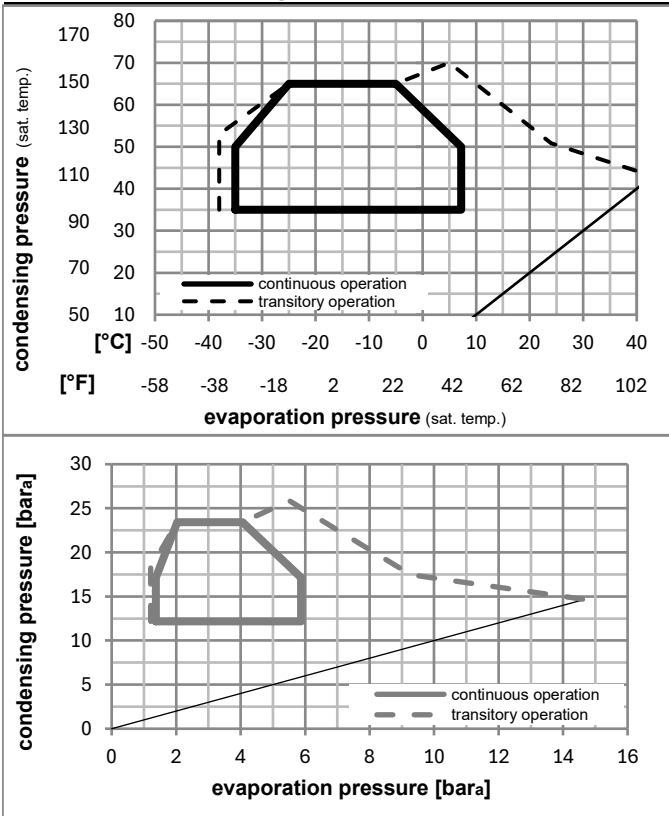

## Components

a1	e-PTC starter	103N0058
e	run capacitor (23,5μF, 6.3mm)	117-7114
b	plastic cover	103N2011
d	cord relief	103N1010
	bracket for run capacitor	117-0300
	screw M4x8mm	117-0301



## Model

Designation	<b>NLE8.8CN</b>	<b>115V/60Hz</b>	<b>Conf. 3</b>	Sales code:	<b>105H6094</b>
-------------	-----------------	------------------	----------------	-------------	-----------------

## Optimization + standard conditions

R290, 115V/60Hz, RSCR, fan 3m/s, UL, CCC

	Evaporating pressure (saturation temperature)				Cooling capacity			COP	EER	P1	Power consumption		Ref. mass flow	
	pe	pc	RGT	Tliq	[W]	[Btu/h]	[kcal/h]				[W]	[A]		
[°C]	-23	54	32	32	519,9	1775	447,4	1,68	5,72	1,44	310,2	4,03	5,26	ASHRAE LBP
[°F]	-10	130	90	90										
[°C]	-25	55	32	55	390,1	1332	335,7	1,30	4,43	1,12	300,5	3,97	4,86	cecomaf LBP
[°F]	-13	131	90	131										
[°C]	-35	40	20	40	306,2	1046	263,5	1,41	4,80	1,21	217,9	3,53	3,50	EN12900 LBP
[°F]	-31	104	68	104										
[°C]	-7	54	35	46	926,3	3163	797,2	2,24	7,67	1,93	412,7	4,66	10,57	ASHRAE MBP
[°F]	20	130	95	115										
[°C]	-10	55	32	55	736,7	2516	634,0	1,88	6,44	1,62	390,9	4,51	9,32	cecomaf MBP
[°F]	14	131	90	131										
[°C]	-10	45	20	45	818,4	2795	704,3	2,24	7,66	1,93	365,0	4,33	10,05	EN12900 MBP
[°F]	14	113	68	113										

## Performance tables

R290, 115V/60Hz, RSCR, fan 3m/s, UL, CCC

	pe		Cooling capacity			COP	EER	P1	I	m	
	[°C]	[°F]	[W]	[Btu/h]	[kcal/h]						[W/W]
[°C / °F]	-35	-31	290,4	992	249,9	1,32	4,50	1,13	220,2	3,52	3,25
cond. pressure	-23	-10	499,4	1706	429,8	1,71	5,84	1,47	292,1	3,94	5,64
pc= 45/113	-15	5	705,0	2408	606,8	2,10	7,16	1,80	336,5	4,17	8,02
return gas temp.	-9	15	869,4	2969	748,2	2,36	8,06	2,03	368,4	4,35	9,95
RGT= 32/90	-4	25	1056,3	3607	909,1	2,60	8,89	2,24	405,6	4,61	12,18
liquid temp	0	32	1200,9	4101	1033,5	2,75	9,40	2,37	436,4	4,86	13,93
Tliq= 45/113	7,2	45	1500,3	5124	1291,1	2,95	10,09	2,54	507,9	5,51	17,63
[°C / °F]	-35	-31	243,4	831	209,5	1,06	3,61	0,91	230,1	3,48	3,01
cond. pressure	-23	-10	420,9	1437	362,2	1,35	4,63	1,17	310,8	4,03	5,25
pc= 55/131	-15	5	603,7	2062	519,5	1,68	5,73	1,44	360,0	4,32	7,59
return gas temp	-9	15	752,6	2570	647,7	1,91	6,51	1,64	394,6	4,54	9,53
RGT= 32/90	-4	25	924,0	3156	795,2	2,13	7,27	1,83	434,0	4,82	11,79
liquid temp	0	32	1057,7	3612	910,2	2,27	7,75	1,95	466,0	5,07	13,58
Tliq= 55/131	7,2	45	1336,6	4565	1150,3	2,48	8,47	2,13	539,2	5,72	17,41



# NL Compressors





## Service/Repair – R600a, R290

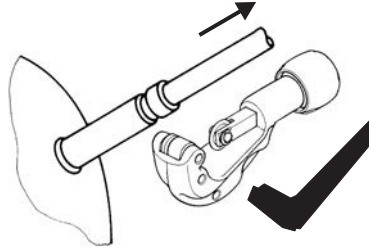

## Brazing on Suction Connectors (Direct Intake)

representative image

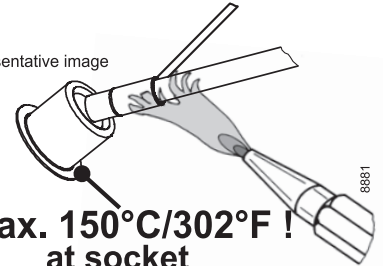

**! max. 150°C/302°F !  
at socket**  
brazing solder: phosphor (LP7) or silver

Refer to Product Bulletin:  
**Brazing on Suction Connectors  
(Compressors with Direct Suction Intake)**

Secop accepts no responsibility for possible errors in catalogs, brochures, and other printed material. Secop reserves the right to alter its products without notice. This also applies to products already on order provided that such alterations can be made without subsequential changes being necessary to specifications already agreed. All trademarks in this material are the property of the respective companies. Secop and the Secop logotype are trademarks of Secop GmbH. All rights reserved. [www.secop.com](http://www.secop.com)