

Single Pack SC21/21G 220-240V 50Hz CSCR

Single pack code number: **195B3269**

Position	Title	Code	Amount
1	Compressor SC21/21G	104G8180	1
2	SC starting device (550mm)	117-7029	2
3	Cord relief	103N1004	2
4	Cover	103N2009	2
5	Bolt joint for one compressor M6 ø16mm	118-1917	2

Secop GmbH • Lise-Meitner-Straße 29 • 24941 Flensburg, Germany • Tel: +49 461 4941 0 • www.secop.com

Secop accepts no responsibility for possible errors in catalogs, brochures, and other printed material. Secop reserves the right to alter its products without notice. This also applies to products already on order provided that such alterations can be made without subsequent changes being necessary to specifications already agreed. All trademarks in this material are the property of the respective companies. Secop and the Secop logotype are trademarks of Secop GmbH. All rights reserved.

Model

Designation	SC21/21G	220-240V/50Hz 1~	Sales code:	104G8180
-------------	-----------------	------------------	-------------	-----------------

Compressor design

Oil type	Polyolester	Refrigerant(s)	R134a
Oil viscosity	22cST	Displacement	41,9cm ³ / 2,56cu.in
Oil quantity	1238cm ³ / 41,9fl.oz	Compressors on pallet	18
Refr. charge - tech. limit	2200g / 77,6oz		
Free gas volume comp.	2920cm ³ / 98,7fl.oz		
Weight	28kg / 61,7lbs		
Motor protection	1# internal		
Winding resistance main	3,5Ω (at 25°C)		
Winding resistance aux	13Ω (at 25°C)		
Max. winding temp.	125°C / 257°F		
Max. discharge temp.	135°C / 275°F		



General - Configurations with SC21/21G

	Conf. 1
Motorconfiguration	CSCR
Power supply (nominal)	220-240V/50Hz
Number of phases	1
Voltage range	187-254V
Approvals	CCC, VDE
Starting torque	HST
Note	- / -

Applications with SC21/21G

	Conf. 1
Refrigerant	R134a
Application	LBP+MBP+HBP
System cooling	fan 3m/s
Hot gas defrost	OK
Long interval pull down	OK

Electrical data - Configurations with SC21/21G

	Conf. 1
Starting device type	relay
Run capacitor	10μF
Start capacitor	80μF
LRA (locked rotor amps / 4s)	2x 22A
RLA (rated load amps / 1s)	2x 3,9A
Cut in current	2x 22A

Model

Designation	SC21/21G	220-240V/50Hz 1~	Sales code:	104G8180
-------------	-----------------	------------------	-------------	-----------------

Compressor dimensions

Housing	A Height	259mm / 10,2in
	B Height	254mm / 10in
	B1	193mm / 7,6in
	B2	110mm / 4,33in

Connectors		Suction	Discharge	Process
		C	E	D
Diameter	[mm]	øi 15,21-15,37	øi 6,11-6,29	øi 6,11-6,29
(i:inside, o:outside)	[in]	øi 0,6-0,61	øi 0,24-0,25	øi 0,24-0,25
Material		steel	copper	copper
Horizontal angle	±2°	0°	37°	37°
Vertical angle	±2°	0°	0°	0°
Position l/h/w	[mm]	0/0/0	0/0/0	0/0/0
	[in]	0/0/0	0/0/0	0/0/0
Straight tube l.	[mm]	10	12	12
	[in]	0,4	0,5	0,5

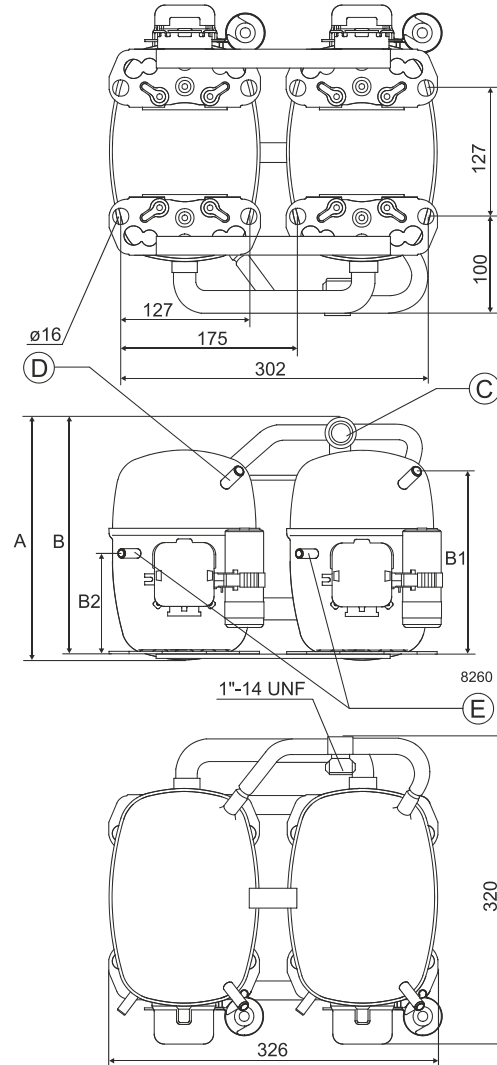

Compressor fixation

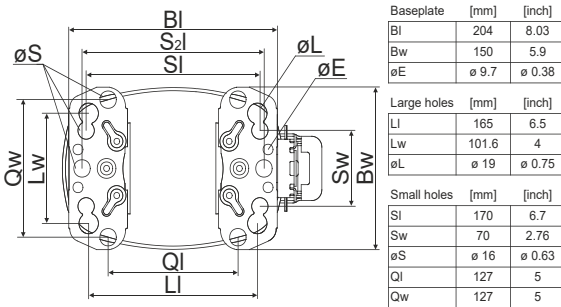

Mounting accessories	one comp.	multi pack
Bolt joint M6 ø16mm	118-1917	118-1918
Bolt joint ø1/4" ø16mm	118-1946	
Bolt joint ø1/4" ø19mm	118-1949	
Snap-on ø7,3 ø16mm	118-1947	118-1919

Bolt joint

Snap-on

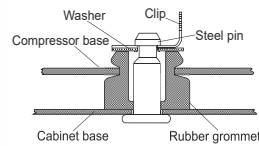
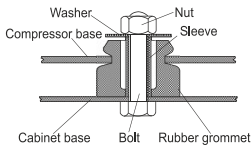

Application notes

Provision for PE Grounding is located at the PE Stamp on the compressor
Twin should be used with a time-delay relay

Model

Designation	SC21/21G	220-240V/50Hz	Conf. 1	Sales code:	104G8180
-------------	-----------------	----------------------	----------------	-------------	-----------------

Configuration

Motorconfiguration	CSCR
Power supply (nominal)	220-240V/50Hz 1~
Refrigerant	R134a
Application	LBP+MBP+HBP
Voltage range	187-254V
Starting torque	HST
Approvals	CCC, VDE,

Ambient/ machine room temperatures minimum /maximum

Ambient temperature range:	10 - 43°C / 50 - 110°F
Machine room temperature range:	10 - 48°C / 50 - 119°F
Compressor cooling:	fan 3m/s

Operation Limits

Electrical accessories / wiring diagram

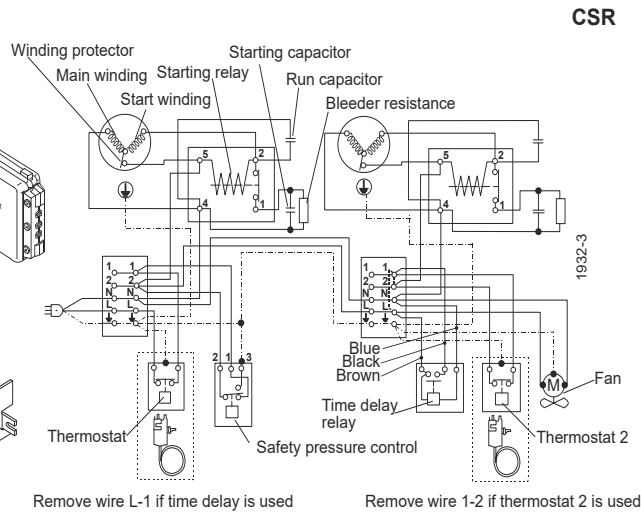
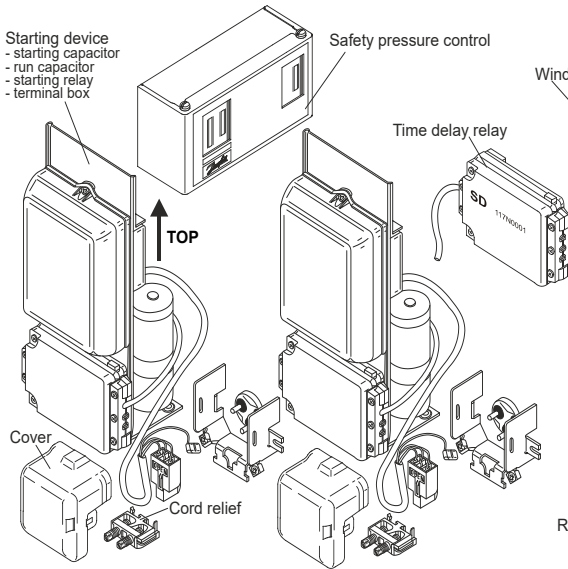

Operation pressure range

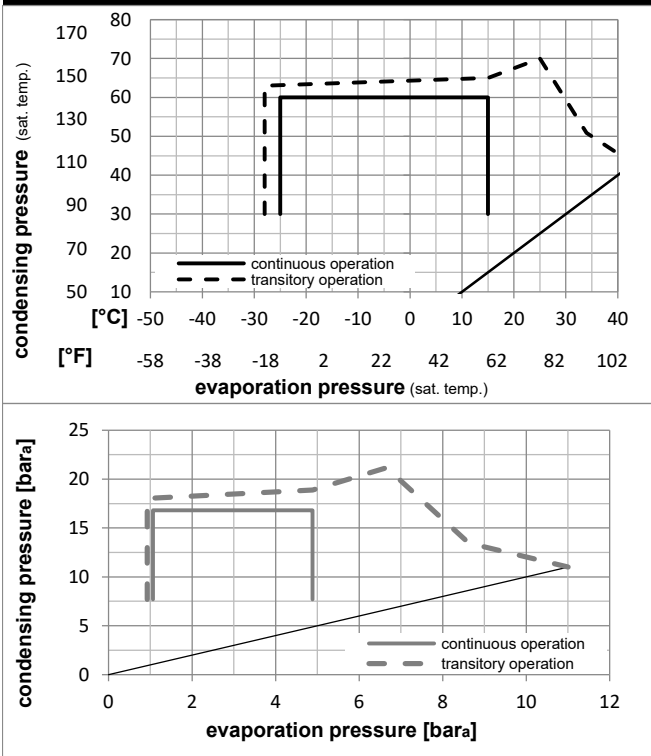

Components

a3	SC starter kit (550mm)	117-7029
b	plastic cover	103N2009
d	cord relief	103N1004
.	Check valve (to be used with time-delay relay)	020-1014
.	Service valve 16mm	118-7351
.	Solder connector (alternative) 16 mm	118-7405
.	Seal ring for service valve and solder conn.	118-3638

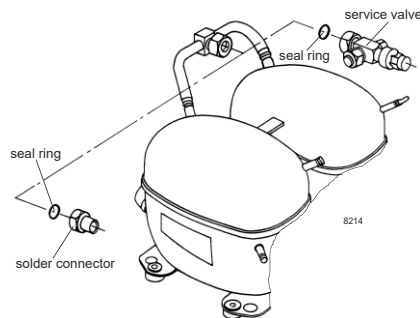

Model

Designation **SC21/21G** **220-240V/50Hz** Conf. 1 Sales code: **104G8180**

Optimization + standard conditions

R134a, 220V/50Hz, CSCR, fan 3m/s, CCC, VDE

		Evaporating pressure (saturation temperature)				Condensing pressure (saturation temperature)						Power consumption			
		Return gas temp.		Liquid temp.		Cooling capacity		COP	EER		Current consumption		Ref. mass flow		
		pe	pc	RGT	Tliq	[W]	[Btu/h]	[kcal/h]	[W/W]	[Btu/Wh]	[kcal/Wh]	P1	I	m	
[°C]	[°F]	[°C]	[°F]	[°C]	[°C]							[W]	[A]	[kg/h]	
-23	-10	54	130	32	32	918,7	3138	790,7	1,13	3,85	0,97	814,5	4,69	17,84	ASHRAE LBP
-7	20	54	130	35	46	2079,2	7101	1789,3	1,67	5,71	1,44	1242,5	6,28	45,36	ASHRAE MBP
7,2	45	54	130	35	46	3779,2	12906	3252,4	2,29	7,83	1,97	1647,6	8,03	83,84	ASHRAE HBP
-35	-31	40	104	20	40	454,5	1552	391,2	0,84	2,88	0,73	538,9	3,93	9,97	EN12900 LBP
-10	14	45	113	20	45	1863,8	6365	1604,0	1,67	5,72	1,44	1112,8	5,75	43,63	EN12900 MBP
5	41	50	122	20	50	3239,8	11064	2788,2	2,10	7,17	1,81	1542,7	7,59	81,64	EN12900 HBP

Performance tables

R134a, 220V/50Hz, CSCR, fan 3m/s, CCC, VDE

	pe		Cooling capacity			COP	EER	P1			I	m
	[°C]	[°F]	[W]	[Btu/h]	[kcal/h]	[W/W]	[Btu/Wh]	[kcal/Wh]	[W]	[A]	[kg/h]	
[°C / °F]	-25	-13	845,5	2888	727,6	1,10	3,75	0,95	769,7	4,52	18,32	
cond. pressure	-20	-4	1142,9	3903	983,6	1,29	4,42	1,11	883,9	4,89	24,83	
pc= 45/113	-10	14	1933,6	6604	1664,1	1,74	5,93	1,50	1112,8	5,75	42,32	
return gas temp.	-5	23	2430,1	8299	2091,4	1,97	6,73	1,70	1232,8	6,24	53,44	
RGT= 32/90	0	32	2996,2	10233	2578,6	2,20	7,53	1,90	1359,7	6,78	66,26	
liquid temp	5	41	3633,5	12409	3127,0	2,43	8,29	2,09	1496,1	7,37	80,89	
Tliq= 45/113	15	59	5127,7	17512	4413,0	2,84	9,69	2,44	1807,5	8,68	116,15	
[°C / °F]	-25	-13	665,1	2271	572,3	0,86	2,95	0,74	770,8	4,55	15,90	
cond. pressure	-20	-4	905,6	3093	779,3	1,01	3,44	0,87	898,7	4,96	21,72	
pc= 55/131	-10	14	1584,5	5411	1363,6	1,37	4,68	1,18	1155,5	5,92	38,31	
return gas temp	-5	23	2026,0	6919	1743,6	1,57	5,37	1,35	1289,4	6,47	49,25	
RGT= 32/90	0	32	2537,8	8667	2184,1	1,77	6,06	1,53	1430,4	7,08	62,08	
liquid temp	5	41	3121,4	10660	2686,3	1,97	6,74	1,70	1581,0	7,73	76,92	
Tliq= 55/131	15	59	4510,3	15403	3881,6	2,35	8,02	2,02	1921,0	9,19	113,29	

SC Twin Compressors

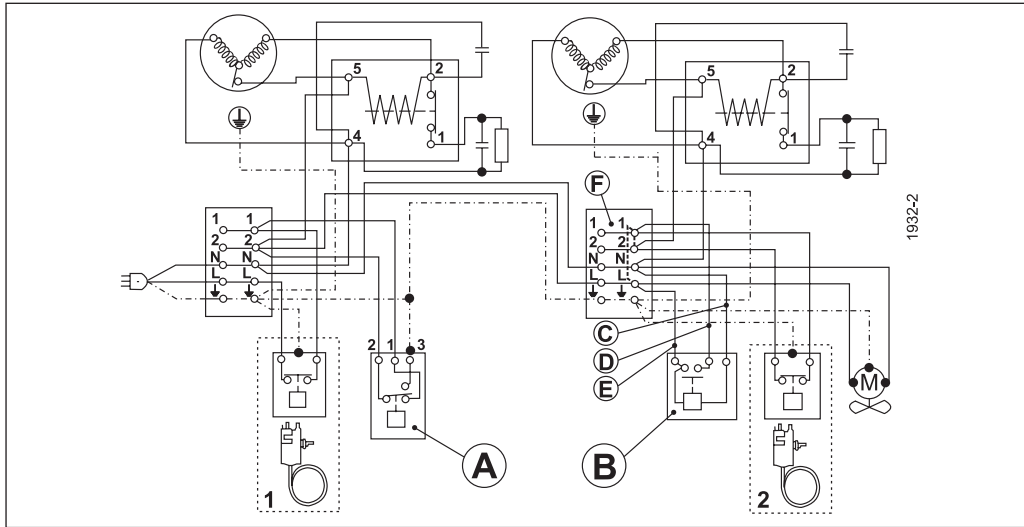
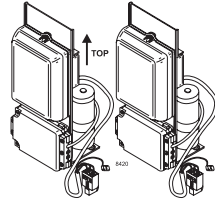
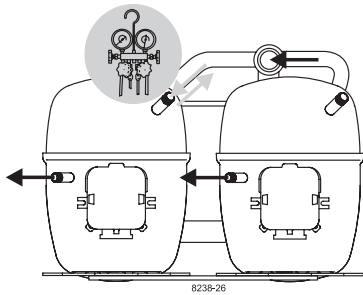

	A	B	C	D	E	F	
ENGLISH	Safety pressure control	Time delay relay	Blue	Black	Brown	Remove wire L-1 if time delay is used	Remove wire 1-2 if thermostat 2 is used
中文	安全压力控制	延时继电器	蓝	黑	棕	若延时继电器使用, 线L-1不使用	若温控器2使用, 线1-2不使用
Русский	Предохранительное реле давления	Реле задержки времени	Синий	Чёрный	Коричневый	Отсоедините провод L-1, если используется реле задержки времени	Отсоедините провод 1-2, если используется термостат 2
DEUTSCH	Sicherheitsdruckschalter	Zeitrelais (verzögernd)	Blau	Schwarz	Braun	Bei Benutzung der Anlaßverzögerung Brücke L-1 entfernen	Bei Benutzung von Thermostat 2 Brücke 1-2 entfernen
FRANÇAIS	Pressostat	Relais de temporisation	Bleu	Noir	Marron	Supprimer la connection L-1 si le relais de temporisation est utilisé	Supprimer la connection 1-2 si thermostat 2 est utilisé
ESPAÑOL	Presostato de seguridad	Relé de retardo	Azul	Negro	Marrón	Quitar cable L-1, si se utiliza un relé de retardo	Quitar cable 1-2, si se utiliza el termostato 2
ITALIANO	Pressostato	Relè di ritardo avviam.	Blu	Nero	Marrone	Eliminare il cavo L-1 se è utilizzato il ritardatore	Eliminare il cavo 1-2 se è utilizzato il termostato 2
NEDERLANDS	Pressostaat	Tijdvertraging-relais	Blauw	Zwart	Bruin	Verwijder draad L-1 indien tijdvertraging wordt toegepast	Verwijder draad 1-2 indien thermostaat wordt toegepast
DANSK	Sikkerhedspressostat	Tidsforsinkelsesrelæ	Blå	Sort	Brun	Ved tidsforsinkelse fjernes ledning L-1	Ved termostat 2 fjernes ledning 1-2
SVENSKA	Säkerhetspressostat	Tidsfördröjningsrelä	Blå	Svart	Brun	Vid anslutning av tidfördröjningsrelä avlägsnas bygling L-1	Vid anslutning av termostat 2 avlägsnas bygling 1-2

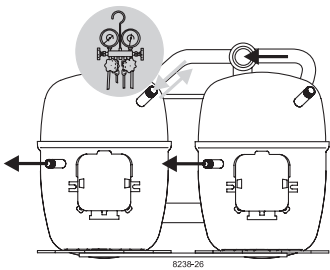

SC Twin Compressors

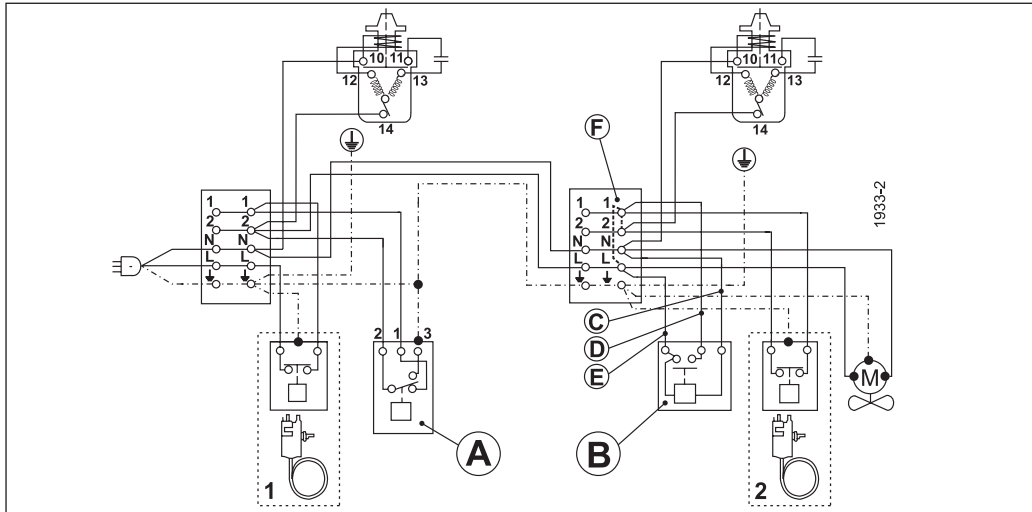
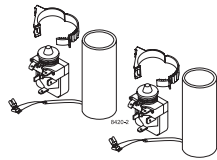

	A	B	C	D	E	F	
ENGLISH	Safety pressure control	Time delay relay	Blue	Black	Brown	Remove wire L-1 if time delay is used	Remove wire 1-2 if thermostat 2 is used
中文	安全压力控制	延时继电器	蓝	黑	棕	若延时继电器使用, 线L-1不使用	若温控器2使用, 线1-2不使用
Русский	Предохранительное реле давления	Реле задержки времени	Синий	Чёрный	Коричневый	Отсоедините провод L-1, если используется реле задержки времени	Отсоедините провод 1-2, если используется термостат 2
DEUTSCH	Sicherheitsdruckschalter	Zeitrelais (verzögernd)	Blau	Schwarz	Braun	Bei Benutzung der Anlaufverzögerung Brücke L-1 entfernen	Bei Benutzung von Thermostat 2 Brücke 1-2 entfernen
FRANÇAIS	Pressostat	Relais de temporisation	Bleu	Noir	Marron	Supprimer la connection L-1 si le relais de temporisation est utilisé	Supprimer la connection 1-2 si thermostat 2 est utilisé
ESPAÑOL	Presostato de seguridad	Relé de retardo	Azul	Negro	Marrón	Quitar cable L-1, si se utiliza un relé de retardo	Quitar cable 1-2, si se utiliza el termostato 2
ITALIANO	Pressostato	Relè di ritardo avviam.	Blu	Nero	Marrone	Eliminare il cavo L-1 se è utilizzato il ritardatore	Eliminare il cavo 1-2 se è utilizzato il termostato 2
NEDERLANDS	Pressostaat	Tijdvertraging-relais	Blauw	Zwart	Bruin	Verwijder draad L-1 indien tijdvertraging wordt toegepast	Verwijder draad 1-2 indien thermostaat wordt toegepast
DANSK	Sikkerhedspressostat	Tidsforsinkelsesrelæ	Blå	Sort	Brun	Ved tidsforsinkelse fjernes ledning L-1	Ved termostat 2 fjernes ledning 1-2
SVENSKA	Säkerhetspressostat	Tidsfördröjningsrelä	Blå	Svart	Brun	Vid anslutning av tidsfördröjningsrelä avlägsnas bygling L-1	Vid anslutning av termostat 2 avlägsnas bygling 1-2

Secop accepts no responsibility for possible errors in catalogs, brochures, and other printed material. Secop reserves the right to alter its products without notice. This also applies to products already on order provided that such alterations can be made without subsequent changes being necessary to specifications already agreed. All trademarks in this material are the property of the respective companies. Secop and the Secop logotype are trademarks of Secop GmbH. All rights reserved. www.secop.com