

Single Pack SC12/12CL 220-240V 50Hz CSIR

Single pack code number: **195B3303**

Position	Title	Code	Amount
1	Compressor SC12/12CL	104L4088	1
2	Starting relay	117U6005	2
3	Starting capacitor (80 μ F 220V, 6.3mm)	117U5017	2
4	Cord relief	103N1004	2
5	Cover	103N2009	2
6	Bolt joint for one compressor M6 \varnothing 16mm	118-1917	2

Secop GmbH • Lise-Meitner-Straße 29 • 24941 Flensburg, Germany • Tel: +49 461 4941 0 • www.secop.com

Secop accepts no responsibility for possible errors in catalogs, brochures, and other printed material. Secop reserves the right to alter its products without notice. This also applies to products already on order provided that such alterations can be made without subsequent changes being necessary to specifications already agreed. All trademarks in this material are the property of the respective companies. Secop and the Secop logotype are trademarks of Secop GmbH. All rights reserved.

Model

Designation	SC12/12CL	220-240V/50Hz 1~	Sales code:	104L4088
-------------	------------------	------------------	-------------	-----------------

Compressor design

Oil type	Polyolester	Refrigerant(s)	R404A, R507
Oil viscosity	32cST	Displacement	25,74cm ³ / 1,57cu.in
Oil quantity	1233cm ³ / 41,7fl.oz	Compressors on pallet	18
Refr. charge - tech. limit	2200g / 77,6oz		
Free gas volume comp.	2820cm ³ / 95,4fl.oz		
Weight	27,3kg / 60,2lbs		
Motor protection	1# internal		
Winding resistance main	5,13Ω (at 25°C)		
Winding resistance aux	13,51Ω (at 25°C)		
Max. winding temp.	125°C / 257°F		
Max. discharge temp.	135°C / 275°F		



General - Configurations with SC12/12CL

	Conf. 1
Motorconfiguration	CSIR
Power supply (nominal)	220-240V/50Hz
Number of phases	1
Voltage range	198-254V
Approvals	CCC, EAC, VDE
Starting torque	HST
Note	- / -

Applications with SC12/12CL

	Conf. 1
Refrigerant	R404A
Application	LBP+MBP
System cooling	fan 3m/s
Hot gas defrost	OK
Long interval pull down	OK

Electrical data - Configurations with SC12/12CL

	Conf. 1
Starting device type	relay
Run capacitor	- / -
Start capacitor	80μF
LRA (locked rotor amps / 4s)	2x 23,4A
RLA (rated load amps / 1s)	2x 4,3A
Cut in current	2x 23,4A

Model

Designation

SC12/12CL

220-240V/50Hz 1~

Sales code:

104L4088

Compressor dimensions

Housing	A Height	249mm / 9,8in
	B Height	244mm / 9,61in
	B1	183mm / 7,2in
	B2	100mm / 3,94in

Connectors		Suction	Discharge	Process
		C	E	D
Diameter	[mm]	øi 15,21-15,37	øi 6,11-6,29	øi 6,11-6,29
(i:inside, o:outside)	[in]	øi 0,6-0,61	øi 0,24-0,25	øi 0,24-0,25
Material		steel	copper	copper
Horizontal angle	±2°	0°	37°	37°
Vertical angle	±2°	0°	0°	0°
Position l/h/w	[mm]	0/0/0	0/0/0	0/0/0
	[in]	0/0/0	0/0/0	0/0/0
Straight tube l.	[mm]	10	12	12
	[in]	0,4	0,5	0,5

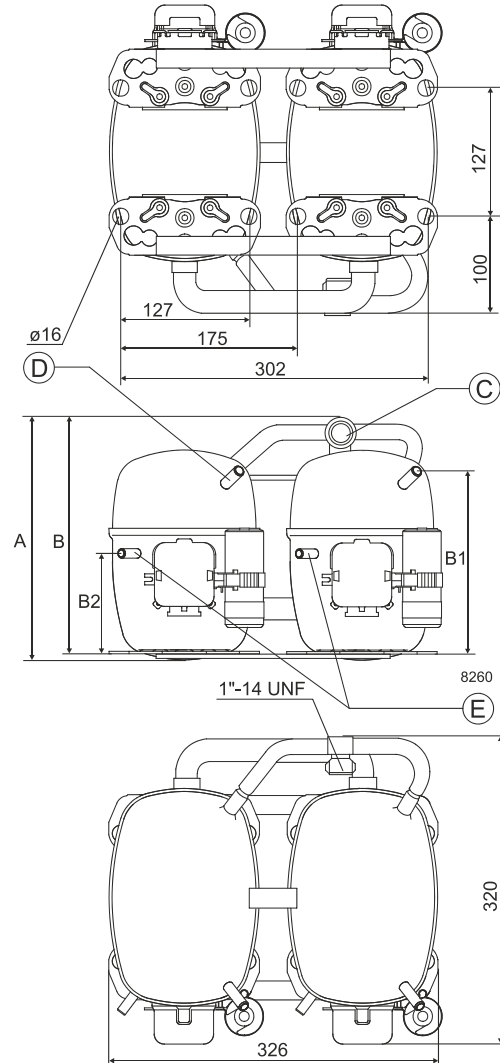

Compressor fixation

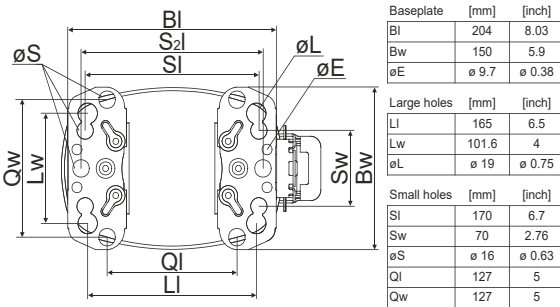

Mounting accessories

	one comp.	multi pack
Bolt joint M6 ø16mm	118-1917	118-1918
Bolt joint ø1/4" ø16mm	118-1946	
Bolt joint ø1/4" ø19mm	118-1949	
Snap-on ø7,3 ø16mm	118-1947	118-1919

Bolt joint

Snap-on

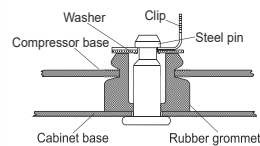
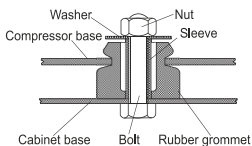

Application notes

Provision for PE Grounding is located at the PE Stamp on the compressor

Twin should be used with a time-delay relay

Model				
Designation	SC12/12CL	220-240V/50Hz	Conf. 1	Sales code: 104L4088

Configuration		Ambient/ machine room temperatures minimum /maximum
Motorconfiguration	CSIR	Ambient temperature range: 10 - 38°C / 50 - 101°F
Power supply (nominal)	220-240V/50Hz 1~	Machine room temperature range: 10 - 43°C / 50 - 110°F
Refrigerant	R404A	Compressor cooling: fan 3m/s
Application	LBP+MBP	
Voltage range	198-254V	
Starting torque	HST	
Approvals	CCC, EAC, VDE	

Operation Limits

Electrical accessories / wiring diagram

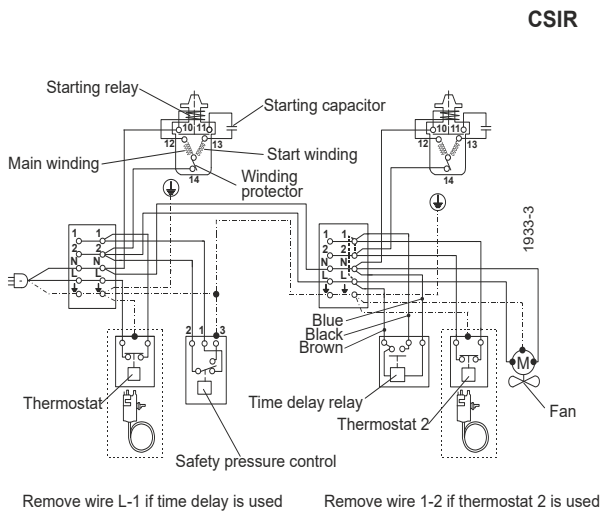
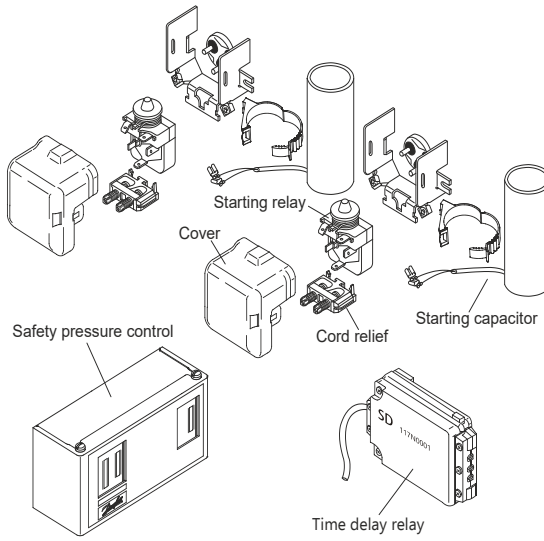

Operation pressure range

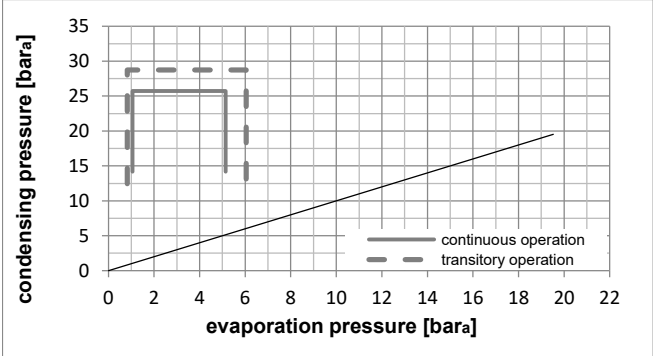
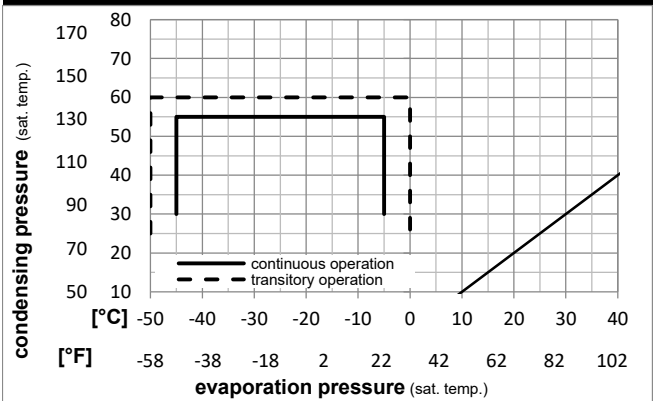

Components

- a2 relay 117U6005
- c start capacitor (80µF) 117U5017
- d cord relief 103N1004
- b plastic cover 103N2009
- . Check valve (to be used with time-delay relay) 020-1014
- . Service valve 12mm 118-7350
- . Solder connector (alternative) 12 mm 104B0584
- . Seal ring for service valve and solder conn. 118-3638

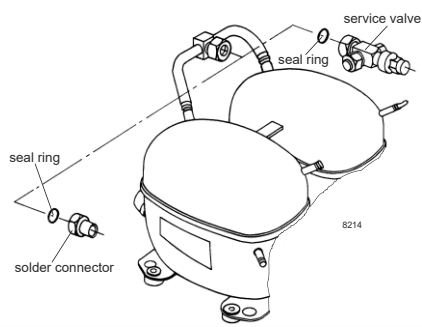

Model

Designation **SC12/12CL** **220-240V/50Hz** Conf. 1 Sales code: **104L4088**

Optimization + standard conditions

R404A, 220V/50Hz, CSIR, fan 3m/s, CCC, EAC, VDE

		Evaporating pressure (saturation temperature)				Condensing pressure (saturation temperature)						Power consumption			
		Return gas temp.		Liquid temp.		Cooling capacity		COP	EER		P1	I	Ref. mass flow		
		pe	pc	RGT	Tliq	[W]	[Btu/h]	[kcal/h]	[W/W]	[Btu/WWh]	[kcal/WWh]	[W]	[A]	[kg/h]	
[°C]	[°F]														
-23	-10	54	130	32	90	1028,8	3514	885,4	1,09	3,74	0,94	939,7	5,79	23,97	ASHRAE LBP
-25	-13	55	131	32	90	667,8	2281	574,7	0,75	2,57	0,65	887,3	5,60	20,87	cecomaf LBP
-35	-31	40	104	20	68	564,9	1929	486,1	0,87	2,99	0,75	645,8	4,86	15,35	EN12900 LBP
-23	-10	49	120	4,4	40	825,1	2818	710,1	0,88	3,00	0,76	939,6	5,82	29,21	ARI540 LBP
-23	-10	41	105	32	90	1339,4	4574	1152,7	1,45	4,94	1,25	925,1	5,73	31,21	AHAM LBP
-35	-31	45	113	32	90	474,6	1621	408,4	0,75	2,56	0,65	632,9	4,85	12,69	opt

Performance tables

R404A, 220V/50Hz, CSIR, fan 3m/s, CCC, EAC, VDE

	pe		Cooling capacity			COP	EER		P1	I	m
	[°C]	[°F]	[W]	[Btu/h]	[kcal/h]	[W/W]	[Btu/WWh]	[kcal/WWh]	[W]	[A]	[kg/h]
[°C / °F]	-45	-49	115,4	394	99,3	0,30	1,04	0,26	379,2	4,30	3,07
cond. pressure	-35	-31	474,6	1621	408,4	0,75	2,56	0,65	632,9	4,85	12,69
pc= 45/113	-30	-22	706,4	2413	608,0	0,93	3,17	0,80	760,6	5,22	18,96
return gas temp.	-25	-13	979,6	3346	843,1	1,10	3,76	0,95	890,6	5,64	26,43
RGT= 32/90	-20	-4	1299,1	4437	1118,0	1,27	4,33	1,09	1024,3	6,13	35,24
liquid temp	-15	5	1669,6	5702	1436,8	1,44	4,90	1,24	1162,8	6,67	45,61
Tliq= 45/113	-5	23	2583,3	8822	2223,2	1,77	6,04	1,52	1460,2	7,94	71,82
[°C / °F]	-45	-49	-78,5	-268	-67,5	-0,29	-0,97	-0,25	275,2	3,96	-2,41
cond. pressure	-35	-31	234,6	801	201,9	0,40	1,38	0,35	581,0	4,66	7,26
pc= 55/131	-30	-22	433,7	1481	373,3	0,59	2,02	0,51	733,4	5,10	13,48
return gas temp	-25	-13	667,8	2281	574,7	0,75	2,57	0,65	887,3	5,60	20,87
RGT= 32/90	-20	-4	941,5	3216	810,3	0,90	3,08	0,78	1043,9	6,16	29,62
liquid temp	-15	5	1260,0	4303	1084,3	1,05	3,57	0,90	1204,6	6,77	39,96
Tliq= 55/131	-5	23	2050,2	7002	1764,4	1,33	4,54	1,14	1543,6	8,19	66,36

SC Twin Compressors

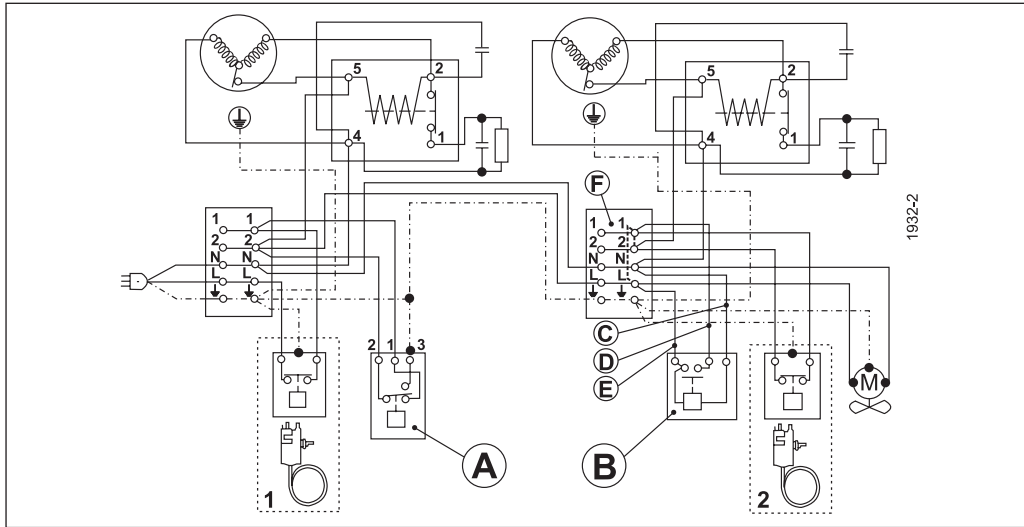
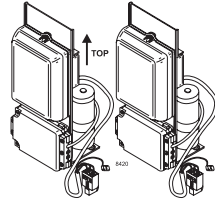
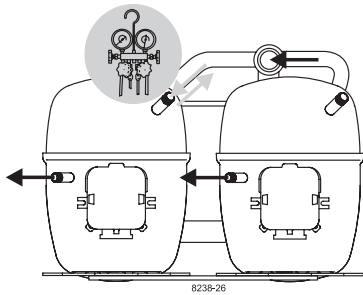

	A	B	C	D	E	F	
ENGLISH	Safety pressure control	Time delay relay	Blue	Black	Brown	Remove wire L-1 if time delay is used	Remove wire 1-2 if thermostat 2 is used
中文	安全压力控制	延时继电器	蓝	黑	棕	若延时继电器使用, 线L-1不使用	若温控器2使用, 线1-2不使用
Русский	Предохранительное реле давления	Реле задержки времени	Синий	Чёрный	Коричневый	Отсоедините провод L-1, если используется реле задержки времени	Отсоедините провод 1-2, если используется термостат 2
DEUTSCH	Sicherheitsdruckschalter	Zeitrelais (verzögernd)	Blau	Schwarz	Braun	Bei Benutzung der Anlaßverzögerung Brücke L-1 entfernen	Bei Benutzung von Thermostat 2 Brücke 1-2 entfernen
FRANÇAIS	Pressostat	Relais de temporisation	Bleu	Noir	Marron	Supprimer la connection L-1 si le relais de temporisation est utilisé	Supprimer la connection 1-2 si thermostat 2 est utilisé
ESPAÑOL	Presostato de seguridad	Relé de retardo	Azul	Negro	Marrón	Quitar cable L-1, si se utiliza un relé de retardo	Quitar cable 1-2, si se utiliza el termostato 2
ITALIANO	Pressostato	Relè di ritardo avviam.	Blu	Nero	Marrone	Eliminare il cavo L-1 se è utilizzato il ritardatore	Eliminare il cavo 1-2 se è utilizzato il termostato 2
NEDERLANDS	Pressostaat	Tijdvertraging-relais	Blauw	Zwart	Bruin	Verwijder draad L-1 indien tijdvertraging wordt toegepast	Verwijder draad 1-2 indien thermostaat wordt toegepast
DANSK	Sikkerhedspressostat	Tidsforsinkelsesrelæ	Blå	Sort	Brun	Ved tidsforsinkelse fjernes ledning L-1	Ved termostat 2 fjernes ledning 1-2
SVENSKA	Säkerhetspressostat	Tidsfördröjningsrelä	Blå	Svart	Brun	Vid anslutning av tidsfördröjningsrelä avlägsnas bygling L-1	Vid anslutning av termostat 2 avlägsnas bygling 1-2

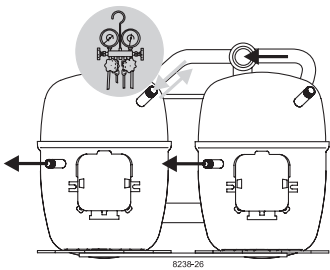

SC Twin Compressors

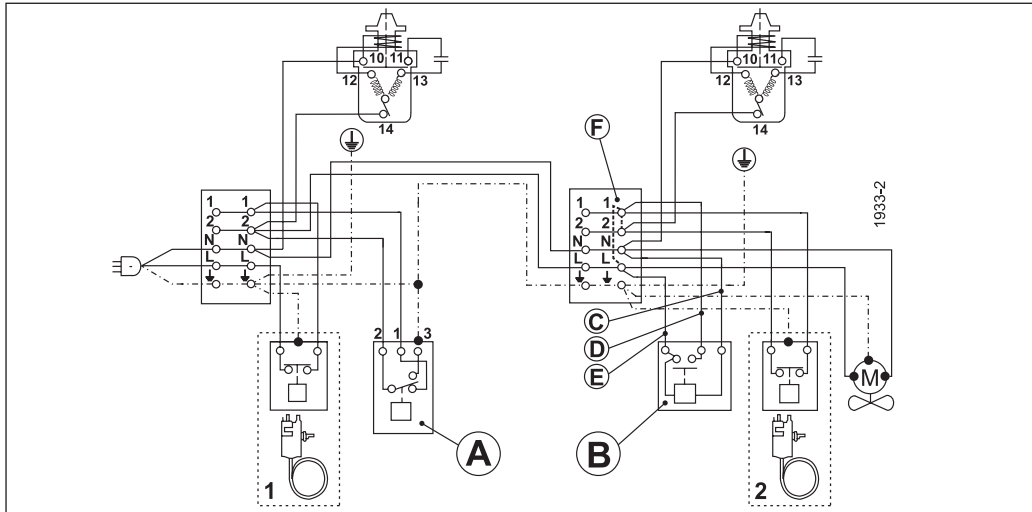
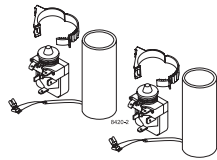

	A	B	C	D	E	F	
ENGLISH	Safety pressure control	Time delay relay	Blue	Black	Brown	Remove wire L-1 if time delay is used	Remove wire 1-2 if thermostat 2 is used
中文	安全压力控制	延时继电器	蓝	黑	棕	若延时继电器使用, 线L-1不使用	若温控器2使用, 线1-2不使用
Русский	Предохранительное реле давления	Реле задержки времени	Синий	Чёрный	Коричневый	Отсоедините провод L-1, если используется реле задержки времени	Отсоедините провод 1-2, если используется термостат 2
DEUTSCH	Sicherheitsdruckschalter	Zeitrelais (verzögernd)	Blau	Schwarz	Braun	Bei Benutzung der Anlaufverzögerung Brücke L-1 entfernen	Bei Benutzung von Thermostat 2 Brücke 1-2 entfernen
FRANÇAIS	Pressostat	Relais de temporisation	Bleu	Noir	Marron	Supprimer la connection L-1 si le relais de temporisation est utilisé	Supprimer la connection 1-2 si thermostat 2 est utilisé
ESPAÑOL	Presostato de seguridad	Relé de retardo	Azul	Negro	Marrón	Quitar cable L-1, si se utiliza un relé de retardo	Quitar cable 1-2, si se utiliza el termostato 2
ITALIANO	Pressostato	Relè di ritardo avviam.	Blu	Nero	Marrone	Eliminare il cavo L-1 se è utilizzato il ritardatore	Eliminare il cavo 1-2 se è utilizzato il termostato 2
NEDERLANDS	Pressostaat	Tijdvertraging-relais	Blauw	Zwart	Bruin	Verwijder draad L-1 indien tijdvertraging wordt toegepast	Verwijder draad 1-2 indien thermostaat wordt toegepast
DANSK	Sikkerhedspressostat	Tidsforsinkelsesrelæ	Blå	Sort	Brun	Ved tidsforsinkelse fjernes ledning L-1	Ved termostat 2 fjernes ledning 1-2
SVENSKA	Säkerhetspressostat	Tidsfördröjningsrelä	Blå	Svart	Brun	Vid anslutning av tidsfördröjningsrelä avlägsnas bygling L-1	Vid anslutning av termostat 2 avlägsnas bygling 1-2

Secop accepts no responsibility for possible errors in catalogs, brochures, and other printed material. Secop reserves the right to alter its products without notice. This also applies to products already on order provided that such alterations can be made without subsequent changes being necessary to specifications already agreed. All trademarks in this material are the property of the respective companies. Secop and the Secop logotype are trademarks of Secop GmbH. All rights reserved. www.secop.com