

Single Pack SCE21CNLX 220-240V 50Hz CSCR

Single pack code number: **195B4284**

Position	Title	Code	Amount
1	Compressor SCE21CNLX	104H8163	1
2	SC starting device (550mm)	117-7806	1
3	Bolt joint for one compressor M6 ø16mm	118-1917	1

Model

Designation	SCE21CNLX	220-240V/50Hz 1~	Sales code:	104H8163
-------------	------------------	------------------	-------------	-----------------

Compressor design

Oil type	Polyolester	Refrigerant(s)	R290
Oil viscosity	32cSt	Displacement	20,95cm ³ / 1,28cu.in
Oil quantity	550cm ³ / 18,6fl.oz	Compressors on pallet	80
Refr. charge - tech. limit	500g / 17,6oz		
Free gas volume comp.	1460cm ³ / 49,4fl.oz		
Weight	14,2kg / 31,3lbs		
Motor protection	external		
Winding resistance main	4,09Ω (at 25°C)		
Winding resistance aux	13,46Ω (at 25°C)		
Max. winding temp.	135°C / 275°F		
Max. discharge temp.	140°C / 284°F		



General - Configurations with SCE21CNLX

	Conf. 1
Motorconfiguration	CSCR
Power supply (nominal)	220-240V/50Hz
Number of phases	1
Voltage range	198-254V
Approvals	VDE, CCC, EAC
Starting torque	HST
Note	Protector and cover are included and pre-assembled to compressor.

Applications with SCE21CNLX

	Conf. 1
Refrigerant	R290
Application	LBP
System cooling	fan 3m/s
Hot gas defrost	OK
Long interval pull down	-/-

Electrical data - Configurations with SCE21CNLX

	Conf. 1
Starting device type	relay
Run capacitor	10μF
Start capacitor	80μF
LRA (locked rotor amps / 4s/ U(N))	18,29A
RLA (rated load amps / 1s/ U(N))	2,95A
Cut in current (U(N))	18,29A

Model

Designation

SCE21CNLX

220-240V/50Hz 1~

Sales code:

104H8163

Compressor dimensions

Housing	A Height	219mm / 8,62in
	B Height	213mm / 8,39in
	C Length shell	218mm / 8,58in
	D Length w. cover	255mm / 10,04in
	E Width	151mm / 5,94in

Connectors	Suction		Discharge		Process	
	X	Y	Z	X	Y	Z
Diameter [mm]	øi 10,11-10,29	øi 6,11-6,29	øi 6,11-6,29	øi 10,11-10,29	øi 6,11-6,29	øi 6,11-6,29
(i:inside, o:outside) [in]	øi 0,4-0,41	øi 0,24-0,25	øi 0,24-0,25	øi 0,4-0,41	øi 0,24-0,25	øi 0,24-0,25
Material	copper	copper	copper	copper	copper	copper
Horizontal angle ±2°	37°	37°	143°	37°	37°	143°
Vertical angle ±2°	30°	0°	150°	30°	0°	150°
Position l/h/w [mm]	107/193/55	115/110/63	-107/193/55	107/193/55	115/110/63	-107/193/55
[in]	4,2/7,6/2,2	4,5/4,3/2,5	-4,2/7,6/2,2	4,2/7,6/2,2	4,5/4,3/2,5	-4,2/7,6/2,2
Straight tube l. [mm]	12	12	12	12	12	12
[in]	0,5	0,5	0,5	0,5	0,5	0,5



Compressor fixation

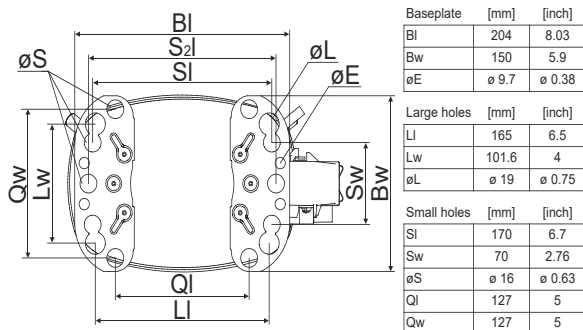

Bolt joint

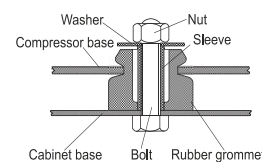

Snap-on

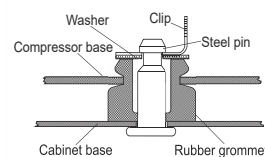

Mounting accessories

	one comp.	multi pack
Bolt joint M6 ø16mm	118-1917	118-1918
Bolt joint ø1/4" ø16mm	118-1946	
Bolt joint ø1/4" ø19mm	118-1949	
Snap-on ø7,3 ø16mm	118-1947	118-1919

Application notes

Provision for PE Grounding is located at the PE Stamp on the compressor

Model

Designation	SCE21CNLX	220-240V/50Hz	Conf. 1	Sales code:	104H8163
-------------	------------------	----------------------	----------------	-------------	-----------------

Configuration

Motor configuration	CSCR
Power supply (nominal)	220-240V/50Hz 1~
Refrigerant	R290
Application	LBP
Voltage range	198-254V
Starting torque	HST
Approvals	VDE
	CCC
	EAC

Electrical accessories / wiring diagram

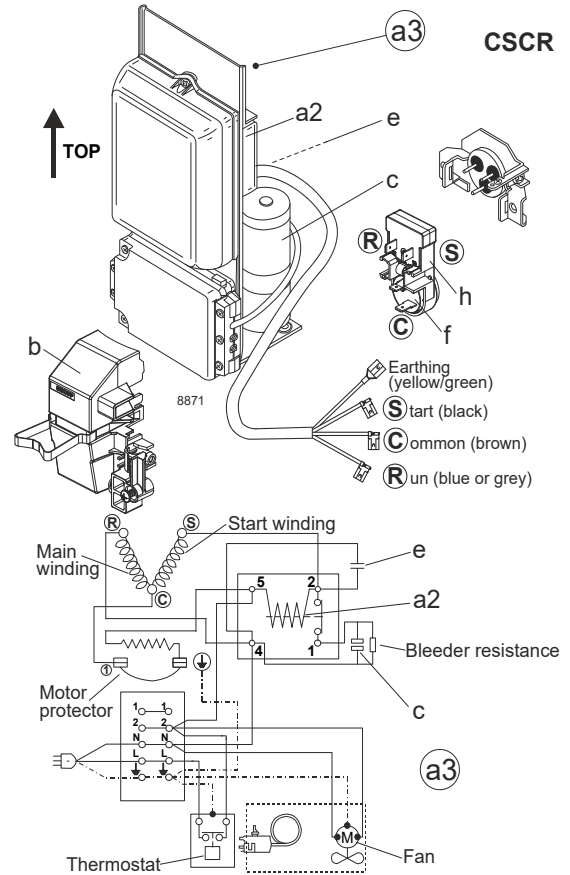

Ambient/ machine room temperatures minimum /maximum

Ambient temperature range:	10 - 43°C / 50 - 110°F
Machine room temperature range:	10 - 48°C / 50 - 119°F
Compressor cooling:	fan 3m/s

Operation pressure range

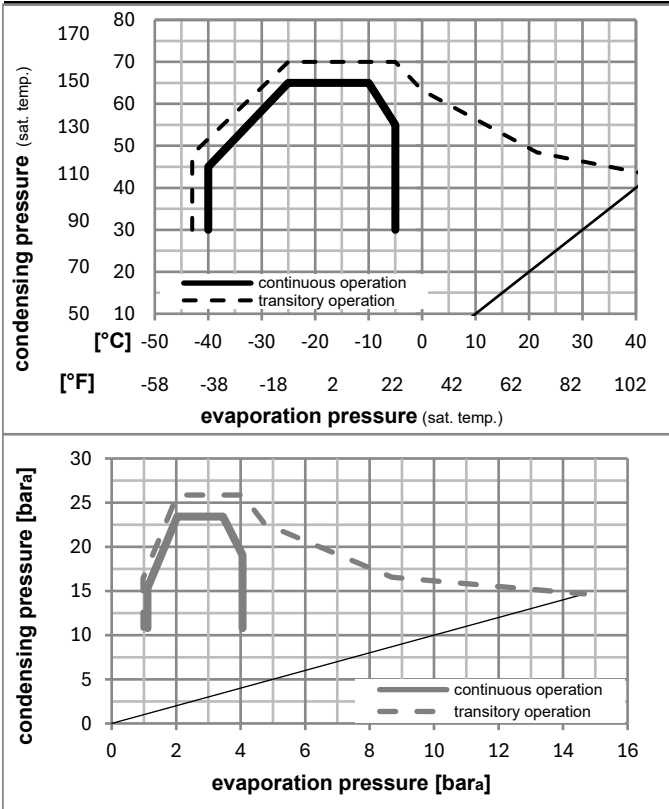

Components (protector (f)+ holder (h)+ cover (b): pre assembled)

a3	SC starter kit (550mm)	117-7806
f / h	motor protector assy. (T1102)	117U8001
b	plastic cover + clamp	117U1028

Alternative comp.

a3	SC starter kit (1000mm)	117-7813
a2	potential relay (RVA 4I3R A57)	117-7600
e	run capacitor (10μF, 6.3mm)	117-7112
c	start capacitor (80μF)	117U5373

Model

Designation **SCE21CNLX** **220-240V/50Hz** Conf. 1 Sales code: **104H8163**

Optimization + standard conditions

R290, 220V/50Hz, CSCR, fan 3m/s, VDE, CCC, EAC

		Evaporating pressure (saturation temperature)				Condensing pressure (saturation temperature)						Power consumption			
		Return gas temp.		Liquid temp.		Cooling capacity		COP	EER		P1	I	Ref. mass flow		
		pe	pc	RGT	Tliq	[W]	[Btu/h]	[kcal/h]	[W/W]	[Btu/Wh]	[kcal/Wh]	[W]	[A]	[kg/h]	
[°C]	[°F]	[°C]	[°F]	[°C]	[°F]										
-23	-10	54	130	32	90	954,0	3258	821,0	1,61	5,49	1,38	593,5	2,81	9,66	ASHRAE LBP
-25	-13	55	131	32	90	710,5	2427	611,5	1,25	4,26	1,07	570,0	2,70	8,85	cecomaf LBP
-35	-31	40	104	20	68	543,1	1855	467,4	1,29	4,40	1,11	421,1	2,03	6,21	EN12900 LBP
-23	-10	49	120	4,4	40	791,5	2703	681,2	1,37	4,69	1,18	576,2	2,74	10,96	ARI540 LBP
-23	-10	41	105	32	90	1075,6	3673	925,6	1,99	6,79	1,71	541,0	2,57	10,89	AHAM LBP
-35	-31	45	113	32	90	508,0	1735	437,2	1,18	4,03	1,01	430,9	2,10	5,69	opt

Performance tables

R290, 220V/50Hz, CSCR, fan 3m/s, VDE, CCC, EAC

	pe		Cooling capacity			COP	EER	P1	I	m	
	[°C]	[°F]	[W]	[Btu/h]	[kcal/h]	[W/W]	[Btu/Wh]	[kcal/Wh]	[W]	[A]	[kg/h]
[°C / °F]	-40	-40	367,3	1254	316,1	0,96	3,27	0,82	383,3	1,92	4,11
cond. pressure	-35	-31	508,0	1735	437,2	1,18	4,03	1,01	430,9	2,10	5,69
pc= 45/113	-30	-22	673,9	2302	580,0	1,39	4,75	1,20	484,4	2,33	7,57
return gas temp.	-25	-13	866,4	2959	745,6	1,60	5,47	1,38	541,3	2,58	9,77
RGT= 32/90	-20	-4	1086,5	3710	935,0	1,81	6,19	1,56	599,0	2,85	12,30
liquid temp	-15	5	1335,5	4561	1149,4	2,04	6,96	1,75	655,1	3,11	15,19
Tliq= 45/113	-5	23	1925,4	6576	1657,0	2,56	8,74	2,20	752,1	3,54	22,17
[°C / °F]	-40	-40	311,5	1064	268,1	0,82	2,81	0,71	378,7	1,88	3,84
cond. pressure	-35	-31	415,8	1420	357,8	0,96	3,27	0,82	434,0	2,10	5,14
pc= 55/131	-30	-22	548,3	1873	471,9	1,10	3,76	0,95	498,6	2,38	6,80
return gas temp	-25	-13	710,5	2427	611,5	1,25	4,26	1,07	570,0	2,70	8,85
RGT= 32/90	-20	-4	903,5	3085	777,5	1,40	4,78	1,20	645,5	3,05	11,30
liquid temp	-15	5	1128,5	3854	971,2	1,56	5,33	1,34	722,7	3,40	14,19
Tliq= 55/131	-5	23	1679,6	5736	1445,5	1,93	6,58	1,66	872,0	4,09	21,40

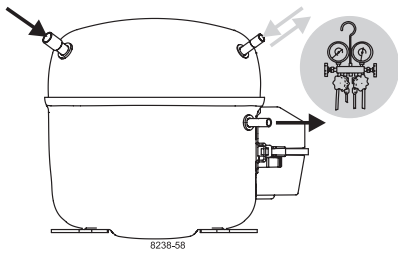

SCE Compressors

(External Protector)

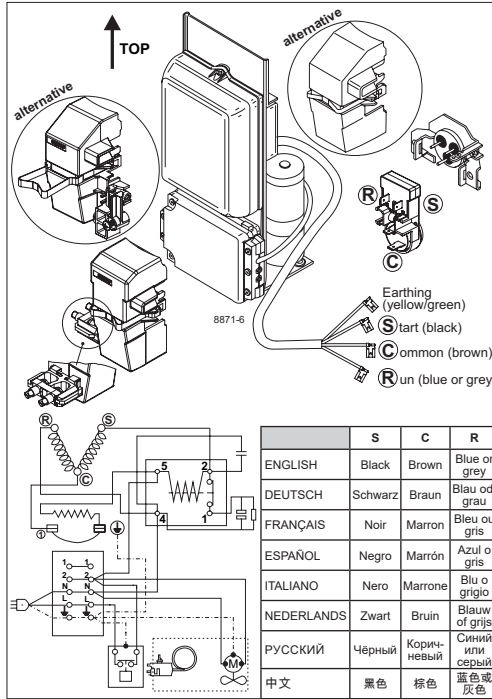

	S	C	R
ENGLISH	Black	Brown	Blue or grey
DEUTSCH	Schwarz	Braun	Blau od. grau
FRANÇAIS	Noir	Marron	Bleu ou gris
ESPAÑOL	Negro	Marrón	Azul o gris
ITALIANO	Nero	Marrone	Blu o grigio
NEDERLANDS	Zwart	Bruin	Blauw of grijs
РУССКИЙ	Чёрный	Коричневый	Синий или серый
中文	黑色	棕色	蓝色或灰色

	S	C	R
ENGLISH	Black	Brown	Blue or grey
DEUTSCH	Schwarz	Braun	Blau od. grau
FRANÇAIS	Noir	Marron	Bleu ou gris
ESPAÑOL	Negro	Marrón	Azul o gris
ITALIANO	Nero	Marrone	Blu o grigio
NEDERLANDS	Zwart	Bruin	Blauw of grijs
РУССКИЙ	Чёрный	Коричневый	Синий или серый
中文	黑色	棕色	蓝色或灰色



SCE Compressors (External Protector)



Service/Repair – R290



8545

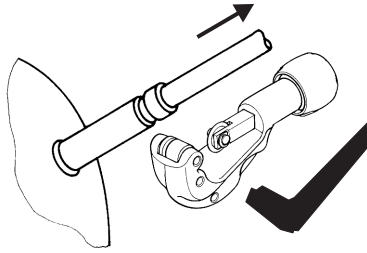

Brazing on Suction Connectors (Direct Intake)



! max. 350°C/662°F !
at socket
 brazing solder: phosphor (LP7) or silver

8882

Refer to Product Bulletin:
Brazing on Suction Connectors
(SCE Compressors with Direct Suction Intake)

Secop accepts no responsibility for possible errors in catalogs, brochures, and other printed material. Secop reserves the right to alter its products without notice. This also applies to products already on order provided that such alterations can be made without subsequential changes being necessary to specifications already agreed. All trademarks in this material are the property of the respective companies. Secop and the Secop logotype are trademarks of Secop GmbH. All rights reserved. www.secop.com