

Single Pack SCE15CNLX 208-230V 60Hz CSIR

Single pack code number: **195B4667**

Position	Title	Code	Amount
1	Compressor SCE15CNLX	104H8588	1
2	Starting capacitor (60µF 260V, 6.3mm)	117U5076	1
3	Bolt joint for one compressor M6 ø16mm	118-1917	1

Secop GmbH • Lise-Meitner-Straße 29 • 24941 Flensburg, Germany • Tel: +49 461 4941 0 • www.secop.com

Secop accepts no responsibility for possible errors in catalogs, brochures, and other printed material. Secop reserves the right to alter its products without notice. This also applies to products already on order provided that such alterations can be made without subsequent changes being necessary to specifications already agreed. All trademarks in this material are the property of the respective companies. Secop and the Secop logotype are trademarks of Secop GmbH. All rights reserved.

Model

Designation	SCE15CNLX	208-230V/60Hz 1~	Sales code:	104H8588
-------------	------------------	------------------	-------------	-----------------

Compressor design

Oil type	Polyolester	Refrigerant(s)	R290
Oil viscosity	32cSt	Displacement	15,28cm ³ / 0,93cu.in
Oil quantity	550cm ³ / 18,6fl.oz	Compressors on pallet	80
Refr. charge - tech. limit	450g / 15,9oz		
Free gas volume comp.	1460cm ³ / 49,4fl.oz		
Weight	14,2kg / 31,3lbs		
Motor protection	external		
Winding resistance main	3,5Ω (at 25°C)		
Winding resistance aux	20,7Ω (at 25°C)		
Max. winding temp.	125°C / 257°F		
Max. discharge temp.	135°C / 275°F		



General - Configurations with SCE15CNLX

	Conf. 1
Motorconfiguration	CSIR
Power supply (nominal)	208-230V/60Hz
Number of phases	1
Voltage range	187-253V
Approvals	UL, KC, CB
Starting torque	HST
Note	Protector, relay and cover are included and pre-assembled to compressor.

Applications with SCE15CNLX

	Conf. 1
Refrigerant	R290
Application	LBP
System cooling	fan 3m/s
Hot gas defrost	OK
Long interval pull down	-/-

Electrical data - Configurations with SCE15CNLX

	Conf. 1
Starting device type	relay
Run capacitor	-/-
Start capacitor	60μF
LRA (locked rotor amps / 4s/ U(N))	20,9A
RLA (rated load amps / 1s/ U(N))	3,8A
Cut in current (U(N))	20,9A

Model

Designation

SCE15CNLX

208-230V/60Hz 1~

Sales code:

104H8588

Compressor dimensions

Housing	A Height	219mm / 8,62in
	B Height	213mm / 8,39in
	C Length shell	218mm / 8,58in
	D Length w. cover	255mm / 10,04in
	E Width	151mm / 5,94in

Connectors		Suction	Discharge	Process
		X	Y	Z
Diameter	[mm]	øi 9,54-9,72	øi 6,41-6,59	øi 6,41-6,59
(i:inside, o:outside)	[in]	øi 0,38-0,38	øi 0,25-0,26	øi 0,25-0,26
Material		copper	copper	copper
Horizontal angle	±2°	37°	37°	143°
Vertical angle	±2°	30°	0°	150°
Position l/h/w	[mm]	107/193/55	115/110/63	-107/193/55
	[in]	4,2/7,6/2,2	4,5/4,3/2,5	-4,2/7,6/2,2
Straight tube l.	[mm]	12	12	12
	[in]	0,5	0,5	0,5



Compressor fixation

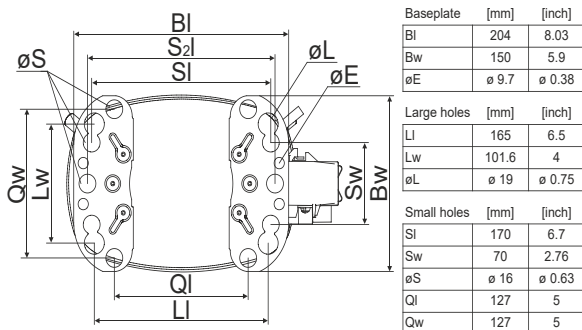

Bolt joint

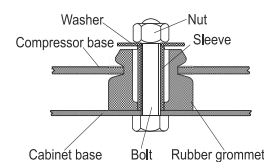

Snap-on

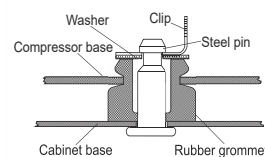

Mounting accessories

	one comp.	multi pack
Bolt joint M6 ø16mm	118-1917	118-1918
Bolt joint ø1/4" ø16mm	118-1946	
Bolt joint ø1/4" ø19mm	118-1949	
Snap-on ø7,3 ø16mm	118-1947	118-1919

Application notes

Provision for PE Grounding is located at the PE Stamp on the compressor

Model

Designation	SCE15CNLX	208-230V/60Hz	Conf. 1	Sales code:	104H8588
-------------	------------------	----------------------	----------------	-------------	-----------------

Configuration

Motor configuration	CSIR
Power supply (nominal)	208-230V/60Hz 1~
Refrigerant	R290
Application	LBP
Voltage range	187-253V
Starting torque	HST
Approvals	UL
	KC
	CB

Electrical accessories / wiring diagram

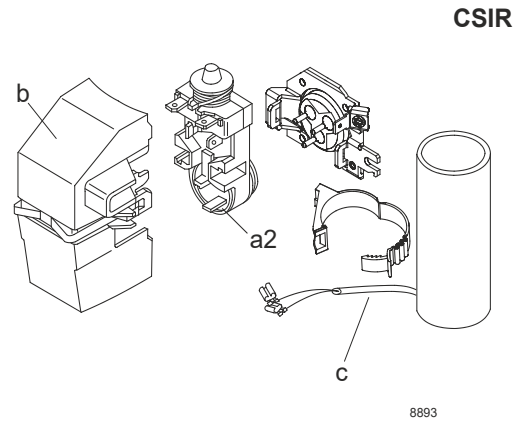

Ambient/ machine room temperatures minimum /maximum

Ambient temperature range:	10 - 43°C / 50 - 110°F
Machine room temperature range:	10 - 48°C / 50 - 119°F
Compressor cooling:	fan 3m/s

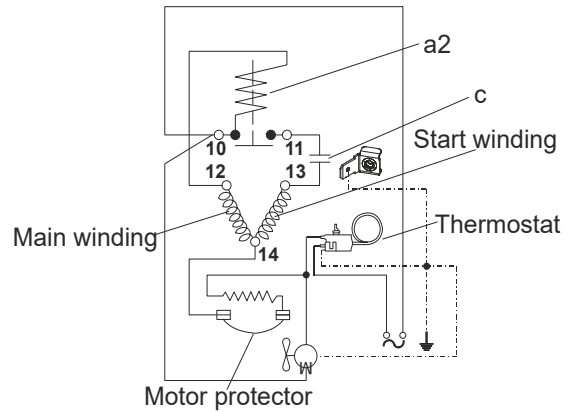

Operation pressure range

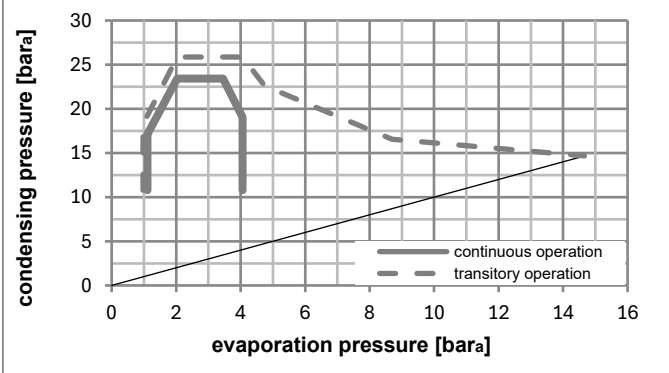
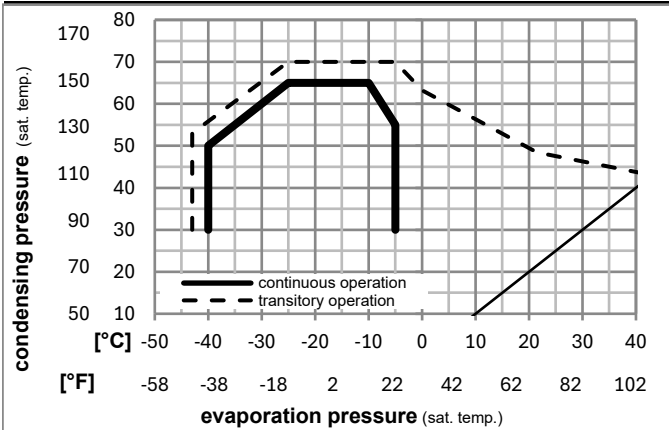

Components (relay (a2)+ cover (b): pre-assembled)

a2	assy. relay + ext. protector (T1120)	117U7413
c	start capacitor (60μF, 6.3mm, 82kOhm)	117U5076
b	plastic cover + clamp	117U1021

Noise emission

Operation pressures:	pe: -25°C / -13°F
	pc: 45°C / 113°F
Motor speed appr.:	3500rpm
Lw(A):	57dB(A)

Model

 Designation **SCE15CNLX 208-230V/60Hz** Conf. 1 Sales code: **104H8588**
Optimization + standard conditions

R290, 230V/60Hz, CSIR, fan 3m/s, UL, KC, CB

	Evaporating pressure (saturation temperature)				Cooling capacity			COP	EER	P1	Power consumption		ASHRAE LBP	
	pe	pc	RGT	Tliq	[W]	[Btu/h]	[kcal/h]				I	Ref. mass flow		
	[°C]	[°F]	[°C]	[°F]	[W]	[Btu/h]	[kcal/h]	[W/W]	[Btu/Wh]	[kcal/Wh]	[W]	[A]	[kg/h]	
	-23	54	32	32	762,3	2603	656,0	1,47	5,03	1,27	517,9	3,05	7,72	ASHRAE LBP
	-10	130	90	90										
	-25	55	32	55	550,2	1879	473,5	1,13	3,87	0,98	485,5	2,95	6,85	cecmaf LBP
	-13	131	90	131										
	-35	40	20	40	415,2	1418	357,3	1,13	3,87	0,98	366,5	2,58	4,74	EN12900 LBP
	-31	104	68	104										
	-23	49	4,4	49	645,5	2204	555,5	1,23	4,19	1,05	526,6	3,05	8,94	ARI540 LBP
	-10	120	40	120										
	-23	41	32	32	908,1	3101	781,5	1,74	5,93	1,50	522,8	3,08	9,20	AHAM LBP
	-10	105	90	90										
	-35	45	32	45	350,7	1198	301,8	1,02	3,48	0,88	344,6	2,48	3,93	opt
	-31	113	90	113										

Performance tables

R290, 230V/60Hz, CSIR, fan 3m/s, UL, KC, CB

	pe		Cooling capacity			COP	EER	P1	I	m	
	[°C]	[°F]	[W]	[Btu/h]	[kcal/h]						
[°C / °F]	-40	-40	198,3	677	170,6	0,80	2,74	0,69	246,8	2,18	2,22
cond. pressure	-34	-30	368,6	1259	317,2	1,04	3,55	0,89	354,6	2,51	4,13
pc= 45/113	-29	-20	559,7	1912	481,7	1,25	4,27	1,08	447,5	2,80	6,30
return gas temp.	-23	-10	776,1	2650	667,9	1,47	5,02	1,27	527,9	3,07	8,76
RGT= 32/90	-21	-5	895,0	3057	770,2	1,59	5,42	1,37	564,2	3,20	10,13
liquid temp	-15	5	1157,1	3952	995,8	1,84	6,27	1,58	630,5	3,45	13,17
Tliq= 45/113	-5	23	1722,5	5883	1482,4	2,34	7,99	2,01	736,1	3,88	19,83
[°C / °F]	-40	-40	38,6	132	33,3	0,29	0,97	0,25	135,6	1,84	0,48
cond. pressure	-34	-30	215,1	735	185,1	0,77	2,61	0,66	281,0	2,29	2,66
pc= 55/131	-29	-20	405,8	1386	349,3	1,00	3,40	0,86	407,2	2,69	5,04
return gas temp	-23	-10	615,2	2101	529,5	1,19	4,07	1,02	516,8	3,06	7,67
RGT= 32/90	-21	-5	728,3	2487	626,8	1,29	4,39	1,11	566,1	3,23	9,10
liquid temp	-15	5	973,8	3326	838,0	1,49	5,07	1,28	655,4	3,55	12,24
Tliq= 55/131	-5	23	1492,7	5098	1284,6	1,89	6,44	1,62	791,6	4,07	19,02

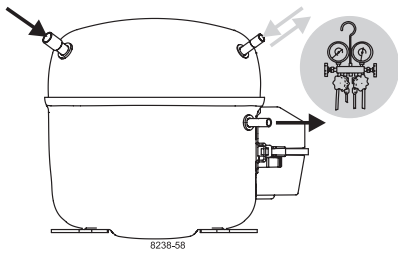

SCE Compressors

(External Protector)

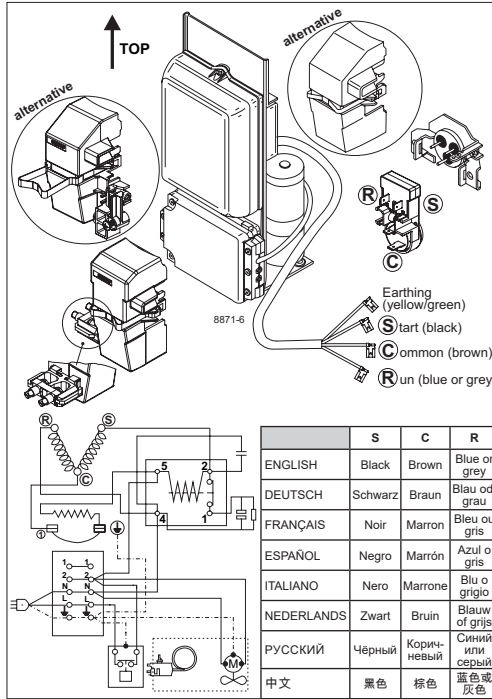

	S	C	R
ENGLISH	Black	Brown	Blue or grey
DEUTSCH	Schwarz	Braun	Blau od. grau
FRANÇAIS	Noir	Marron	Bleu ou gris
ESPAÑOL	Negro	Marrón	Azul o gris
ITALIANO	Nero	Marrone	Blu o grigio
NEDERLANDS	Zwart	Bruin	Blauw of grijs
РУССКИЙ	Чёрный	Коричневый	Синий или серый
中文	黑色	棕色	蓝色或灰色

	S	C	R
ENGLISH	Black	Brown	Blue or grey
DEUTSCH	Schwarz	Braun	Blau od. grau
FRANÇAIS	Noir	Marron	Bleu ou gris
ESPAÑOL	Negro	Marrón	Azul o gris
ITALIANO	Nero	Marrone	Blu o grigio
NEDERLANDS	Zwart	Bruin	Blauw of grijs
РУССКИЙ	Чёрный	Коричневый	Синий или серый
中文	黑色	棕色	蓝色或灰色



SCE Compressors (External Protector)



Service/Repair – R290

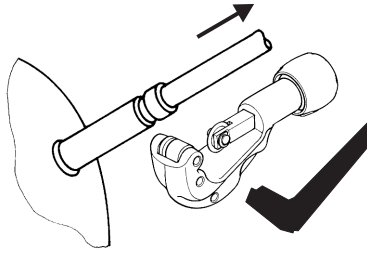

8545

Brazing on Suction Connectors (Direct Intake)



! max. 350°C/662°F !
at socket
brazing solder: phosphor (LP7) or silver

8882

Refer to Product Bulletin:
Brazing on Suction Connectors
(SCE Compressors with Direct Suction Intake)

Secop accepts no responsibility for possible errors in catalogs, brochures, and other printed material. Secop reserves the right to alter its products without notice. This also applies to products already on order provided that such alterations can be made without subsequential changes being necessary to specifications already agreed. All trademarks in this material are the property of the respective companies. Secop and the Secop logotype are trademarks of Secop GmbH. All rights reserved. www.secop.com