

Single Pack SC18CL 220-240V 50Hz CSCR

Single pack code number: **195B4022**

Position	Title	Code	Amount
1	Compressor SC18CL	104L2123	1
2	SC starting device (550mm)	117-7027	1
3	Cord relief	103N1004	1
4	Cover	103N2009	1
5	Bolt joint for one compressor M6 ø16mm	118-1917	1

Secop GmbH • Lise-Meitner-Straße 29 • 24941 Flensburg, Germany • Tel: +49 461 4941 0 • www.secop.com

Secop accepts no responsibility for possible errors in catalogs, brochures, and other printed material. Secop reserves the right to alter its products without notice. This also applies to products already on order provided that such alterations can be made without subsequent changes being necessary to specifications already agreed. All trademarks in this material are the property of the respective companies. Secop and the Secop logotype are trademarks of Secop GmbH. All rights reserved.

Model

Designation	SC18CL	220-240V/50Hz 1~	Sales code:	104L2123
-------------	---------------	------------------	-------------	-----------------

Compressor design

Oil type	Polyolester	Refrigerant(s)	R404A, R452A, R507
Oil viscosity	32cST	Displacement	17,69cm ³ / 1,08cu.in
Oil quantity	601cm ³ / 20,3fl.oz	Compressors on pallet	80
Refr. charge - tech. limit	1300g / 45,9oz		
Free gas volume comp.	1460cm ³ / 49,4fl.oz		
Weight	13,8kg / 30,4lbs		
Motor protection	1# internal		
Winding resistance main	3,7Ω (at 25°C)		
Winding resistance aux	14Ω (at 25°C)		
Max. winding temp.	125°C / 257°F		
Max. discharge temp.	130°C / 266°F		



General - Configurations with SC18CL

	Conf. 1	Conf. 2
Motorconfiguration	CSCR	CSCR
Power supply (nominal)	220-240V/50Hz	220-240V/50Hz
Number of phases	1	1
Voltage range	198-254V	198-254V
Approvals	VDE, CCC, EAC	VDE, CCC
Starting torque	HST	HST
Note	- / -	

Applications with SC18CL

	Conf. 1	Conf. 2
Refrigerant	R404A	R452A
Application	LBP+MBP	LBP+MBP
System cooling	fan 3m/s	fan 3m/s
Hot gas defrost	OK	OK
Long interval pull down	OK	OK

Electrical data - Configurations with SC18CL

	Conf. 1	Conf. 2
Starting device type	relay	relay
Run capacitor	10μF	10μF
Start capacitor	80μF	80μF
LRA (locked rotor amps / 4s)	20,43A	20,43A
RLA (rated load amps / 1s)	4,2A	4,2A
Cut in current	20,43A	20,43A

Model

Designation

SC18CL

220-240V/50Hz 1~

Sales code:

104L2123

Compressor dimensions

Housing	A Height	219mm / 8,62in
	B Height	213mm / 8,39in
	C Length shell	218mm / 8,58in
	D Length w. cover	255mm / 10,04in
	E Width	151mm / 5,94in

Connectors	Suction X	Discharge Y	Process Z
Diameter [mm]	øi 10,11-10,29	øi 6,11-6,29	øi 6,11-6,29
(i:inside, o:outside) [in]	øi 0,4-0,41	øi 0,24-0,25	øi 0,24-0,25
Material	copper	copper	copper
Horizontal angle ±2°	37°	37°	143°
Vertical angle ±2°	30°	0°	150°
Position l/h/w [mm]	107/193/55	115/110/63	-107/193/55
[in]	4,2/7,6/2,2	4,5/4,3/2,5	-4,2/7,6/2,2
Straight tube l. [mm]	12	12	12
[in]	0,5	0,5	0,5



Compressor fixation



Baseplate	[mm]	[inch]
BI	204	8.03
Bw	150	5.9
øE	ø 9.7	ø 0.38
Large holes	[mm]	[inch]
LI	165	6.5
Lw	101.6	4
øL	ø 19	ø 0.75
Small holes	[mm]	[inch]
SI	170	6.7
Sw	70	2.76
øS	ø 16	ø 0.63
QI	127	5
Qw	127	5

Bolt joint

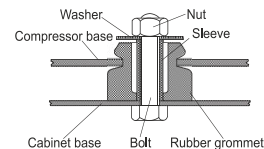

Snap-on

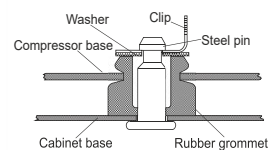

Mounting accessories

Mounting accessories	one comp.	multi pack
Bolt joint M6 ø16mm	118-1917	118-1918
Bolt joint ø1/4" ø16mm	118-1946	
Bolt joint ø1/4" ø19mm	118-1949	
Snap-on ø7,3 ø16mm	118-1947	118-1919

Application notes

Provision for PE Grounding is located at the PE Stamp on the compressor

Model

Designation	SC18CL	220-240V/50Hz	Conf. 1	Sales code:	104L2123
-------------	---------------	----------------------	----------------	-------------	-----------------

Configuration

Motorconfiguration	CSCR
Power supply (nominal)	220-240V/50Hz 1~
Refrigerant	R404A
Application	LBP+MBP
Voltage range	198-254V
Starting torque	HST
Approvals	VDE CCC EAC

Electrical accessories / wiring diagram



Ambient/ machine room temperatures minimum /maximum

Ambient temperature range:	10 - 38°C / 50 - 101°F
Machine room temperature range:	10 - 43°C / 50 - 110°F
Compressor cooling:	fan 3m/s

Operation Limits

Operation pressure range

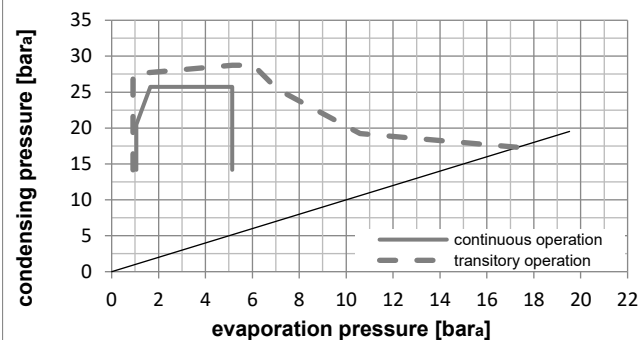
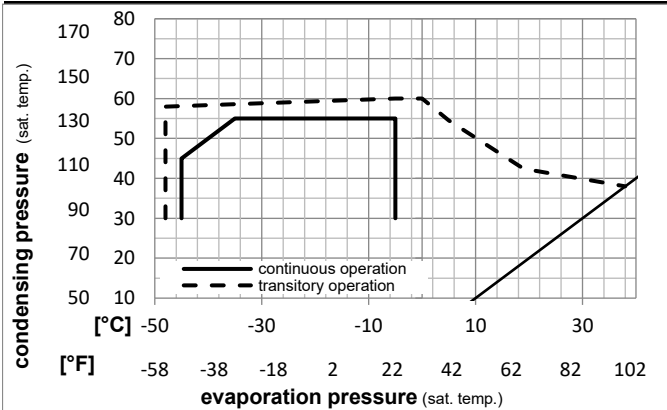

Components

a3	SC starter kit (550mm)	117-7027
b	plastic cover	103N2009
d	cord relief	103N1004

Alternative components

a3	SC starter kit (1000mm)	117-7040
a3	SC starter kit (650mm)	117-7046
c	start capacitor (80µF)	117U5373
e	run capacitor (10µF, 6.3mm)	117-7112

Model

Designation **SC18CL** **220-240V/50Hz** Conf. 1 Sales code: **104L2123**

Optimization + standard conditions

R404A, 220V/50Hz, CSCR, fan 3m/s, VDE, CCC, EAC

		Evaporating pressure (saturation temperature)				Condensing pressure (saturation temperature)			Return gas temp.		Liquid temp.		Cooling capacity			COP	EER	Power consumption			
		pe	pc	RGT	Tliq	[W]	[Btu/h]	[kcal/h]	[W/W]	[Btu/Wh]	[kcal/Wh]	P1	I	Current consumption		Ref. mass flow					
[°C]	[°F]											[W]	[A]	[kg/h]							
-23	54	32	32	800,9	2735	689,3	1,21	4,14	1,04	660,0	3,78	18,66	ASHRAE LBP								
-10	130	90	90																		
-25	55	32	55	538,7	1840	463,6	0,86	2,92	0,74	629,0	3,65	16,83	cecomaf LBP								
-13	131	90	131																		
-35	40	20	40	436,2	1490	375,4	0,97	3,30	0,83	451,0	3,01	11,85	EN12900 LBP								
-31	104	68	104																		
-7	54	35	46	1510,0	5157	1299,5	1,50	5,11	1,29	1009,3	5,33	41,55	ASHRAE MBP								
20	130	95	115																		
-10	55	32	55	1123,6	3837	967,0	1,20	4,11	1,04	933,1	4,99	35,97	cecomaf MBP								
14	131	90	131																		
-10	45	20	45	1342,7	4585	1155,5	1,50	5,13	1,29	894,0	4,80	40,44	EN12900 MBP								
14	113	68	113																		

Performance tables

R404A, 220V/50Hz, CSCR, fan 3m/s, VDE, CCC, EAC

	pe		Cooling capacity			COP	EER	P1	I	m	
	[°C]	[°F]	[W]	[Btu/h]	[kcal/h]	[W/W]	[Btu/Wh]	[kcal/Wh]	[W]	[A]	[kg/h]
[°C / °F]	-45	-49	166,7	569	143,5	0,57	1,94	0,49	293,6	2,61	4,43
cond. pressure	-35	-31	394,5	1347	339,6	0,87	2,96	0,75	455,2	3,02	10,55
pc= 45/113	-30	-22	541,8	1850	466,3	1,01	3,47	0,87	534,0	3,29	14,54
return gas temp.	-25	-13	715,3	2443	615,6	1,16	3,97	1,00	614,8	3,60	19,30
RGT= 32/90	-20	-4	918,3	3136	790,3	1,31	4,48	1,13	700,1	3,96	24,92
liquid temp	-15	5	1153,9	3941	993,0	1,46	4,97	1,25	792,3	4,36	31,52
Tliq= 45/113	-5	23	1734,8	5925	1493,0	1,72	5,88	1,48	1007,6	5,29	48,23
[°C / °F]	-45	-49	83,9	286	72,2	0,33	1,14	0,29	252,2	2,47	2,58
cond. pressure	-35	-31	275,1	940	236,8	0,62	2,11	0,53	444,8	2,97	8,51
pc= 55/131	-30	-22	396,3	1353	341,1	0,74	2,52	0,64	536,7	3,29	12,32
return gas temp	-25	-13	538,7	1840	463,6	0,86	2,92	0,74	629,0	3,65	16,83
RGT= 32/90	-20	-4	705,3	2409	606,9	0,97	3,33	0,84	724,2	4,05	22,19
liquid temp	-15	5	899,2	3071	773,9	1,09	3,72	0,94	824,7	4,50	28,52
Tliq= 55/131	-5	23	1381,5	4718	1188,9	1,31	4,49	1,13	1051,7	5,52	44,72

Model

Designation	SC18CL	220-240V/50Hz	Conf. 2	Sales code:	104L2123
-------------	---------------	----------------------	----------------	-------------	-----------------

Configuration

Motorconfiguration	CSCR
Power supply (nominal)	220-240V/50Hz 1~
Refrigerant	R452A
Application	LBP+MBP
Voltage range	198-254V
Starting torque	HST
Approvals	VDE CCC

Electrical accessories / wiring diagram

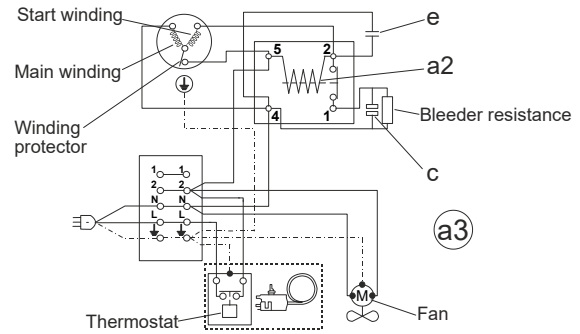

Ambient/ machine room temperatures minimum /maximum

Ambient temperature range:	10 - 38°C / 50 - 101°F
Machine room temperature range:	10 - 43°C / 50 - 110°F
Compressor cooling:	fan 3m/s

Operation Limits

Operation pressure range

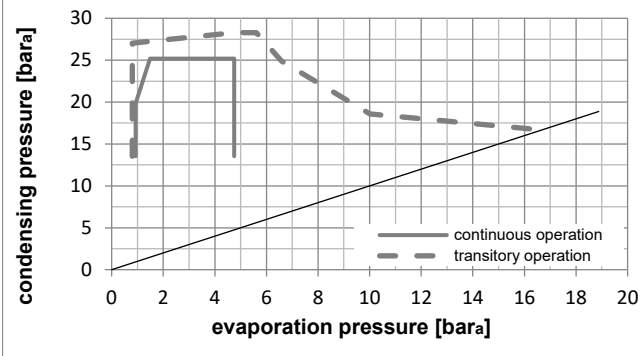
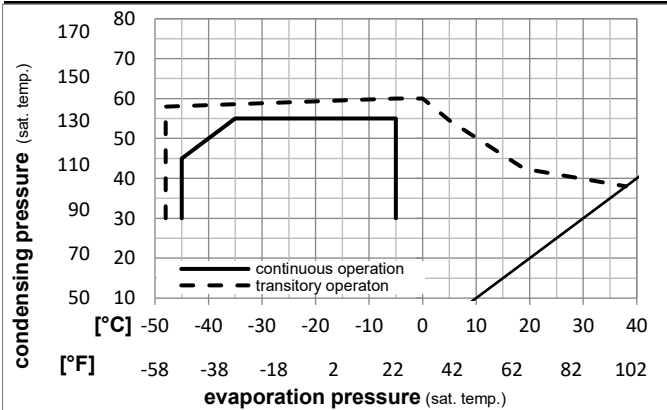

Components

a3	SC starter kit (550mm)	117-7027
b	plastic cover	103N2009
d	cord relief	103N1004

Alternative components

a3	SC starter kit (1000mm)	117-7040
a3	SC starter kit (650mm)	117-7046
c	start capacitor (80µF)	117U5373
e	run capacitor (10µF, 6.3mm)	117-7112

Model

Designation **SC18CL** **220-240V/50Hz** Conf. 2 Sales code: **104L2123**

Optimization + standard conditions

R452A, 220V/50Hz, CSCR, fan 3m/s, VDE, CCC

	Evaporating pressure (saturation temperature)				Cooling capacity			COP	EER	P1	Power consumption			ASHRAE LBP
	pe	pc	RGT	Tliq	[W]	[Btu/h]	[kcal/h]				l	Ref. mass flow		
	[°C]	[°F]	[°C]	[°F]	[W]	[Btu/h]	[kcal/h]	[W/W]	[Btu/Wh]	[kcal/Wh]	[W]	[A]	[kg/h]	
	-23	54	32	32	732,0	2500	630,0	1,19	4,07	1,03	613,6	2,95	17,59	ASHRAE LBP
	-10	130	90	90										
	-25	55	32	55	496,2	1695	427,1	0,85	2,91	0,73	583,1	2,83	15,79	cecomaf LBP
	-13	131	90	131										
	-35	40	20	40	393,1	1342	338,3	0,95	3,24	0,82	414,5	2,13	10,98	EN12900 LBP
	-31	104	68	104										
	-7	54	35	46	1429,2	4881	1230,0	1,49	5,09	1,28	958,1	4,48	40,21	ASHRAE MBP
	20	130	95	115										
	-10	55	32	55	1065,1	3637	916,6	1,21	4,12	1,04	882,4	4,11	34,62	cecomaf MBP
	14	131	90	131										
	-10	45	20	45	1268,5	4332	1091,7	1,50	5,12	1,29	845,9	3,95	38,98	EN12900 MBP
	14	113	68	113										

Performance tables

R452A, 220V/50Hz, CSCR, fan 3m/s, VDE, CCC

	pe		Cooling capacity			COP	EER	P1	l	m	
	[°C]	[°F]	[W]	[Btu/h]	[kcal/h]						
[°C / °F]	-45	-49	140,1	478	120,5	0,54	1,85	0,47	258,3	1,38	3,82
cond. pressure	-35	-31	354,2	1210	304,9	0,85	2,90	0,73	416,7	2,16	9,72
pc= 45/113	-30	-22	493,5	1686	424,7	1,00	3,41	0,86	493,6	2,49	13,59
return gas temp.	-25	-13	658,8	2250	567,0	1,15	3,93	0,99	572,5	2,81	18,23
RGT= 32/90	-20	-4	853,5	2915	734,5	1,30	4,45	1,12	655,7	3,14	23,73
liquid temp	-15	5	1080,8	3691	930,1	1,45	4,95	1,25	746,0	3,52	30,23
Tliq= 45/113	-5	23	1647,0	5625	1417,4	1,72	5,87	1,48	957,9	4,48	46,80
[°C / °F]	-45	-49	64,7	221	55,7	0,30	1,03	0,26	213,8	1,27	2,03
cond. pressure	-35	-31	245,0	837	210,8	0,61	2,08	0,52	402,7	2,11	7,73
pc= 55/131	-30	-22	360,1	1230	309,9	0,73	2,50	0,63	492,7	2,47	11,40
return gas temp	-25	-13	496,2	1695	427,1	0,85	2,91	0,73	583,1	2,83	15,79
RGT= 32/90	-20	-4	656,9	2243	565,3	0,97	3,32	0,84	676,5	3,20	21,03
liquid temp	-15	5	845,4	2887	727,5	1,09	3,72	0,94	775,4	3,62	27,25
Tliq= 55/131	-5	23	1319,3	4506	1135,4	1,32	4,50	1,14	1000,2	4,69	43,30



SC Compressors





SC Compressors

Service/Repair – R290



8545



Secop accepts no responsibility for possible errors in catalogs, brochures, and other printed material. Secop reserves the right to alter its products without notice. This also applies to products already on order provided that such alterations can be made without subsequent changes being necessary to specifications already agreed. All trademarks in this material are the property of the respective companies. Secop and the Secop logotype are trademarks of Secop GmbH. All rights reserved. www.secop.com