

Single Pack NF10FX 220-240V 50Hz / 208-230V 60Hz CSIR

Single pack code number: **195B4026**

Position	Title	Code	Amount
1	Compressor NF10FX	105G6846	1
2	Starting relay (overload protector MRP56EN-6)	117U4139	1
3	Starting capacitor (125µF 220V, 6.3mm)	117U5018	1
4	Cord relief	117U0349	2
5	Cover	117U1021	1
6	Bolt joint for one compressor M6 ø16mm	118-1917	1

Secop GmbH • Lise-Meitner-Straße 29 • 24941 Flensburg, Germany • Tel: +49 461 4941 0 • www.secop.com

Secop accepts no responsibility for possible errors in catalogs, brochures, and other printed material. Secop reserves the right to alter its products without notice. This also applies to products already on order provided that such alterations can be made without subsequent changes being necessary to specifications already agreed. All trademarks in this material are the property of the respective companies. Secop and the Secop logotype are trademarks of Secop GmbH. All rights reserved.

Model

Designation	NF10FX	220-240V/50Hz 1~ 208-230V/60Hz 1~	Sales code:	105G6846
-------------	---------------	--	-------------	-----------------

Compressor design

Oil type	Polyolester	Refrigerant(s)	R134a, R513A, 0
Oil viscosity	32cST	Displacement	10,09cm ³ / 0,62cu.in
Oil quantity	298cm ³ / 10,1fl.oz	Compressors on pallet	80
Refr. charge - tech. limit	460g / 16,2oz		
Free gas volume comp.	2360cm ³ / 79,8fl.oz		
Weight	10,5kg / 23,1lbs		
Motor protection	external		
Winding resistance main	4,5Ω (at 25°C)		
Winding resistance aux	12,8Ω (at 25°C)		
Max. winding temp.	125°C / 257°F		
Max. discharge temp.	110°C / 230°F		



General - Configurations with NF10FX

	Conf. 1	Conf. 2	Conf. 3	Conf. 4
Motorconfiguration	CSIR	CSIR	CSIR	CSIR
Power supply (nominal)	220-240V/50Hz	220-240V/50Hz	208-230V/60Hz	208-230V/60Hz
Number of phases	1	1	1	1
Voltage range	198-242V	198-242V	198-242V	198-242V
Approvals	UL, VDE, CCC, EAC	UL, VDE, CCC, EAC	UL, VDE, CCC, EAC	UL, VDE, CCC, EAC
Starting torque	HST	HST	HST	HST
Note	- / -			

Applications with NF10FX

	Conf. 1	Conf. 2	Conf. 3	Conf. 4
Refrigerant	R134a	R513A	R134a	R513A
Application	LBP+MBP	LBP+MBP	LBP+MBP	LBP+MBP
System cooling	fan 1,5m/s	fan 1,5m/s	fan 3m/s	fan 3m/s
Hot gas defrost	OK	OK	OK	OK
Long interval pull down	OK	OK	OK	OK

Electrical data - Configurations with NF10FX

	Conf. 1	Conf. 2	Conf. 3	Conf. 4
Starting device type	relay	relay	relay	relay
Run capacitor	- / -	- / -	- / -	- / -
Start capacitor	125μF	125μF	125μF	125μF
LRA (locked rotor amps / 4s/ U(N))	20A	20A	19,4A	19,4A
RLA (rated load amps / 1s/ U(N))	3,7A	3,7A	3,24A	3,24A
Cut in current (U(N))	20A	20A	19,4A	19,4A

Model

Designation	NF10FX	220-240V/50Hz 1~ 208-230V/60Hz 1~	Sales code:	105G6846
-------------	---------------	-----------------------------------	-------------	-----------------

Compressor dimensions

Housing	A Height	203mm / 7,99in
	B Height	197mm / 7,76in
	C Length shell	205mm / 8,07in
	D Length w. cover	254mm / 10in
	E Width	166mm / 6,54in

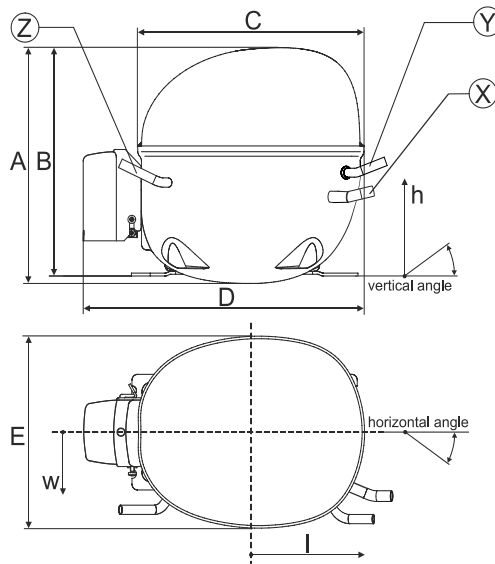

Connectors		Suction	Discharge	Process
		X	Y	Z
Diameter	[mm]	øi 8,11-8,29	øi 6,41-6,59	øi 6,41-6,59
(i:inside, o:outside)	[in]	øi 0,32-0,33	øi 0,25-0,26	øi 0,25-0,26
Material		copper	copper	copper
Horizontal angle	±2°	0°	0°	0°
Vertical angle	±2°	15°	35°	155°
Position l/h/w	[mm]	126/76/78	133/103/54	-107/94/72
	[in]	4,9/3/3,1	5,2/4/2,1	-4,2/3,7/2,8
Straight tube l.	[mm]	12	12	12
	[in]	0,5	0,5	0,5

Compressor fixation

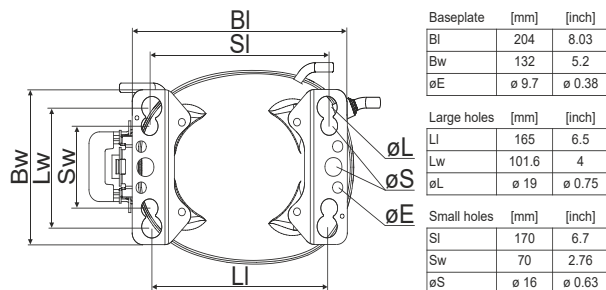

Bolt joint



Snap-on

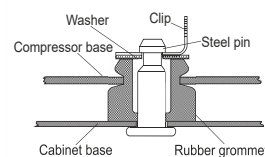

Mounting accessories	one comp.	multi pack
Bolt joint M6 ø16mm	118-1917	118-1918
Bolt joint ø1/4" ø16mm	118-1946	
Bolt joint ø1/4" ø19mm	118-1949	
Snap-on ø7,3 ø16mm	118-1947	118-1919

Application notes

Provision for PE Grounding is located at the PE Stamp on the compressor

Model

Designation	NF10FX	220-240V/50Hz	Conf. 1	Sales code:	105G6846
-------------	---------------	----------------------	----------------	-------------	-----------------

Configuration

Motor configuration	CSIR	
Power supply (nominal)	220-240V/50Hz 1~	
Refrigerant	R134a	
Application	LBP+MBP	
Voltage range	198-242V	
Starting torque	HST	
Approvals	UL	SA3693
	VDE	
	CCC	
	EAC	

Electrical accessories / wiring diagram



Ambient/ machine room temperatures minimum /maximum

Ambient temperature range:	10 - 38°C / 50 - 101°F
Machine room temperature range:	10 - 43°C / 50 - 110°F
Compressor cooling:	fan 1,5m/s

Operation pressure range

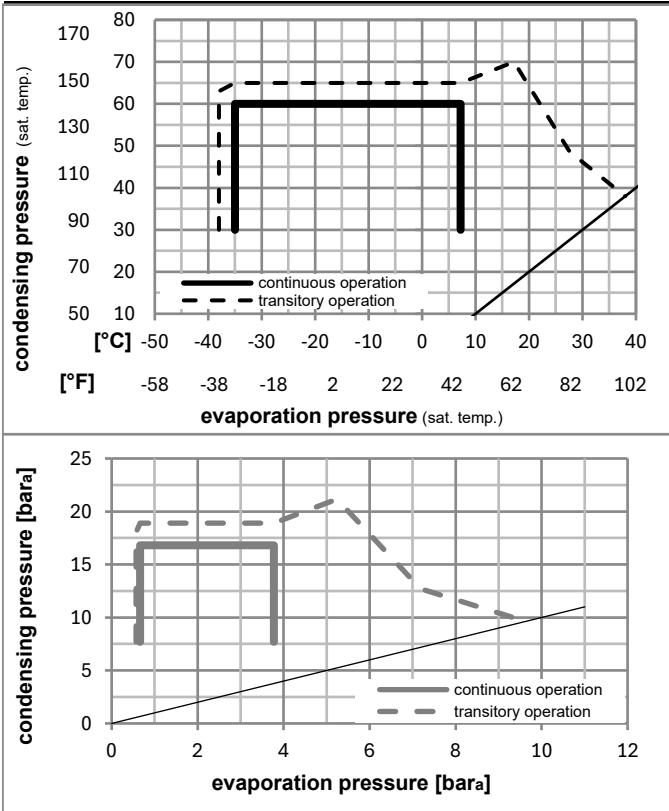

Components

a2	relay (protector: TI MRP56EN-6)	117U4139
c	start capacitor	117U5018
b	plastic cover	117U1021
d/dc	cord relief	117U0349
d/dc	cord relief	117U0349

Alternative components

a2	relay (protector: TI MRP56EN-6)	117U4139
c	start capacitor	117U5018
b	plastic cover	117U1021
d/dc	cord relief	117U0349
d	cord relief	117U0317

Model

Designation **NF10FX** **220-240V/50Hz** Conf. 1 Sales code: **105G6846**

Optimization + standard conditions

R134a, 220V/50Hz, CSIR, fan 1,5m/s, UL, VDE, CCC, EAC

	Evaporating pressure (saturation temperature)				Condensing pressure (saturation temperature)			Return gas temp.			Liquid temp.			Cooling capacity			COP	EER	Power consumption		
	pe	pc	RGT	Tliq	[W]	[Btu/h]	[kcal/h]	[W/W]	[Btu/Wh]	[kcal/Wh]	P1	I	Current consumption		Ref. mass flow						
	[°C]	[°C]	[°C]	[°C]	[W]	[Btu/h]	[kcal/h]	[W/W]	[Btu/Wh]	[kcal/Wh]	[W]	[A]	[A]		[kg/h]						
ASHRAE LBP	-23	54	32	32	266,5	910	229,4	0,94	3,22	0,81	282,7	2,75	5,18								
	[°F]	[°F]	[°F]	[°F]	[W]	[Btu/h]	[kcal/h]	[W/W]	[Btu/Wh]	[kcal/Wh]	[W]	[A]	[A]		[kg/h]						
cecomaf LBP	-25	55	32	55	196,4	671	169,0	0,72	2,47	0,62	271,1	2,73	4,70								
	[°C]	[°C]	[°C]	[°C]	[W]	[Btu/h]	[kcal/h]	[W/W]	[Btu/Wh]	[kcal/Wh]	[W]	[A]	[A]		[kg/h]						
	[°F]	[°F]	[°F]	[°F]	[W]	[Btu/h]	[kcal/h]	[W/W]	[Btu/Wh]	[kcal/Wh]	[W]	[A]	[A]		[kg/h]						
EN12900 LBP	-35	40	20	40	137,8	471	118,6	0,65	2,24	0,56	210,6	2,67	3,02								
	[°C]	[°C]	[°C]	[°C]	[W]	[Btu/h]	[kcal/h]	[W/W]	[Btu/Wh]	[kcal/Wh]	[W]	[A]	[A]		[kg/h]						
	[°F]	[°F]	[°F]	[°F]	[W]	[Btu/h]	[kcal/h]	[W/W]	[Btu/Wh]	[kcal/Wh]	[W]	[A]	[A]		[kg/h]						
ASHRAE MBP	-7	54	35	46	556,9	1902	479,3	1,42	4,86	1,23	391,1	2,96	12,15								
	[°C]	[°C]	[°C]	[°C]	[W]	[Btu/h]	[kcal/h]	[W/W]	[Btu/Wh]	[kcal/Wh]	[W]	[A]	[A]		[kg/h]						
	[°F]	[°F]	[°F]	[°F]	[W]	[Btu/h]	[kcal/h]	[W/W]	[Btu/Wh]	[kcal/Wh]	[W]	[A]	[A]		[kg/h]						
cecomaf MBP	-10	55	32	55	432,5	1477	372,2	1,17	4,01	1,01	368,4	2,91	10,46								
	[°C]	[°C]	[°C]	[°C]	[W]	[Btu/h]	[kcal/h]	[W/W]	[Btu/Wh]	[kcal/Wh]	[W]	[A]	[A]		[kg/h]						
	[°F]	[°F]	[°F]	[°F]	[W]	[Btu/h]	[kcal/h]	[W/W]	[Btu/Wh]	[kcal/Wh]	[W]	[A]	[A]		[kg/h]						
EN12900 MBP	-10	45	20	45	479,1	1636	412,3	1,34	4,58	1,15	357,3	2,85	11,21								
	[°C]	[°C]	[°C]	[°C]	[W]	[Btu/h]	[kcal/h]	[W/W]	[Btu/Wh]	[kcal/Wh]	[W]	[A]	[A]		[kg/h]						
	[°F]	[°F]	[°F]	[°F]	[W]	[Btu/h]	[kcal/h]	[W/W]	[Btu/Wh]	[kcal/Wh]	[W]	[A]	[A]		[kg/h]						

Performance tables

R134a, 220V/50Hz, CSIR, fan 1,5m/s, UL, VDE, CCC, EAC

	pe		Cooling capacity			COP	EER		P1	I	m
	[°C]	[°F]	[W]	[Btu/h]	[kcal/h]	[W/W]	[Btu/Wh]	[kcal/Wh]	[W]	[A]	[kg/h]
[°C / °F]	-35	-31	128,4	439	110,5	0,60	2,05	0,52	213,8	2,67	2,77
cond. pressure	-23	-10	254,9	870	219,3	0,91	3,11	0,78	279,6	2,74	5,53
pc= 45/113	-15	5	392,2	1340	337,6	1,20	4,08	1,03	328,2	2,81	8,55
return gas temp.	-9	15	509,8	1741	438,7	1,41	4,83	1,22	360,5	2,86	11,16
RGT= 32/90	-4	25	650,6	2222	559,9	1,66	5,67	1,43	392,2	2,92	14,32
liquid temp	0	32	764,2	2610	657,7	1,85	6,31	1,59	413,8	2,96	16,90
Tliq= 45/113	7,2	45	1010,7	3452	869,9	2,24	7,63	1,92	452,2	3,05	22,58
[°C / °F]	-35	-31	103,5	353	89,0	0,49	1,67	0,42	211,0	2,65	2,46
cond. pressure	-23	-10	216,4	739	186,2	0,77	2,62	0,66	281,6	2,74	5,18
pc= 55/131	-15	5	338,8	1157	291,6	1,01	3,45	0,87	335,4	2,84	8,16
return gas temp	-9	15	443,9	1516	382,1	1,19	4,08	1,03	372,1	2,92	10,74
RGT= 32/90	-4	25	570,4	1948	490,9	1,40	4,77	1,20	408,8	3,01	13,88
liquid temp	0	32	672,8	2298	579,0	1,55	5,29	1,33	434,3	3,07	16,46
Tliq= 55/131	7,2	45	896,1	3060	771,2	1,86	6,36	1,60	480,8	3,21	22,16

Model

Designation	NF10FX	220-240V/50Hz	Conf. 2	Sales code:	105G6846
-------------	---------------	----------------------	----------------	-------------	-----------------

Configuration

Motor configuration	CSIR	
Power supply (nominal)	220-240V/50Hz 1~	
Refrigerant	R513A	
Application	LBP+MBP	
Voltage range	198-242V	
Starting torque	HST	
Approvals	UL	SA3693
	VDE	
	CCC	
	EAC	

Electrical accessories / wiring diagram

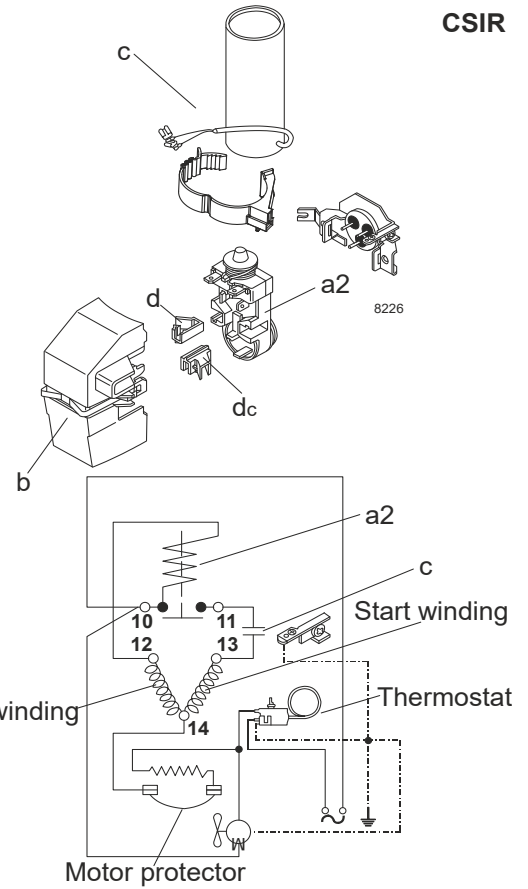

Ambient/ machine room temperatures minimum /maximum

Ambient temperature range:	10 - 38°C / 50 - 101°F
Machine room temperature range:	10 - 43°C / 50 - 110°F
Compressor cooling:	fan 1,5m/s

Operation pressure range

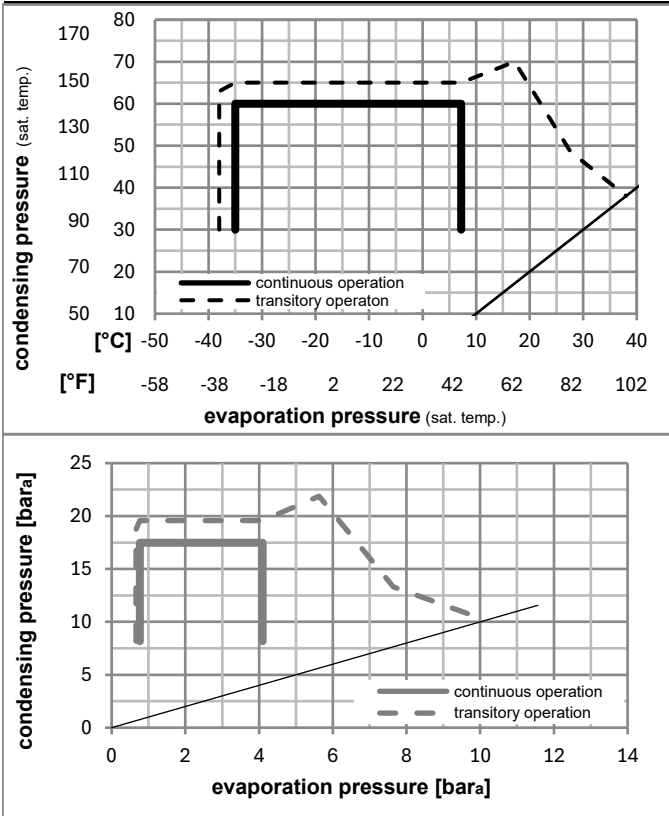

Components

a2	relay (protector: TI MRP56EN-6)	117U4139
c	start capacitor	117U5018
b	plastic cover	117U1021
d/dc	cord relief	117U0349
d/dc	cord relief	117U0349

Alternative components

a2	relay (protector: TI MRP56EN-6)	117U4139
c	start capacitor	117U5018
b	plastic cover	117U1021
d/dc	cord relief	117U0349
d	cord relief	117U0317

Model

Designation **NF10FX** **220-240V/50Hz** Conf. 2 Sales code: **105G6846**

Optimization + standard conditions

R513A, 220V/50Hz, CSIR, fan 1,5m/s, UL, VDE, CCC, EAC

	pe	pc	RGT	Tliq	Cooling capacity		COP	EER		P1	I	Ref. mass flow	
	[°C]	[°C]	[°C]	[°C]	[W]	[Btu/h]	[W/W]	[Btu/Wh]	[kcal/Wh]	[W]	[A]	[kg/h]	
Evaporating pressure (saturation temperature)	-23	54	32	32	294,2	1005	0,95	3,25	0,82	309,2	2,77	6,33	ASHRAE LBP
Condensing pressure (saturation temperature)	-10	130	90	90									
Return gas temp.													
Liquid temp.													
Power consumption													
Current consumption													
Ref. mass flow													
	[°C]	[°C]	[°C]	[°C]	[W]	[Btu/h]	[W/W]	[Btu/Wh]	[kcal/Wh]	[W]	[A]	[kg/h]	
	[°F]	[°F]	[°F]	[°F]	[W]	[Btu/h]	[W/W]	[Btu/Wh]	[kcal/Wh]	[W]	[A]	[kg/h]	
	-25	55	32	55	211,0	721	0,71	2,42	0,61	297,7	2,75	5,78	cecomaf LBP
	-13	131	90	131									
	-35	40	20	40	153,1	523	0,65	2,23	0,56	234,3	2,62	3,79	EN12900 LBP
	-31	104	68	104									
	-7	54	35	46	583,4	1992	1,40	4,78	1,21	416,4	2,98	14,29	ASHRAE MBP
	20	130	95	115									
	-10	55	32	55	447,7	1529	1,14	3,88	0,98	393,9	2,94	12,38	cecomaf MBP
	14	131	90	131									
	-10	45	20	45	499,9	1707	1,31	4,48	1,13	381,3	2,91	13,25	EN12900 MBP
	14	113	68	113									

Performance tables

R513A, 220V/50Hz, CSIR, fan 1,5m/s, UL, VDE, CCC, EAC

	pe	Cooling capacity			COP	EER	P1	I	m		
	[°C]	[°F]	[W]	[Btu/h]	[kcal/h]	[W/W]	[Btu/Wh]	[kcal/Wh]	[W]	[A]	[kg/h]
[°C / °F]	-35	-31	143,8	491	123,8	0,60	2,05	0,52	239,0	2,63	3,49
cond. pressure	-23	-10	275,5	941	237,1	0,91	3,09	0,78	304,3	2,76	6,72
pc= 45/113	-15	5	416,3	1422	358,3	1,18	4,03	1,02	352,5	2,86	10,20
return gas temp.	-9	15	535,6	1829	461,0	1,39	4,76	1,20	384,5	2,92	13,17
RGT= 32/90	-4	25	677,5	2314	583,1	1,63	5,57	1,40	415,7	2,98	16,74
liquid temp	0	32	791,3	2703	681,0	1,81	6,19	1,56	436,9	3,02	19,63
Tliq= 45/113	7,2	45	1037,0	3542	892,5	2,19	7,47	1,88	474,2	3,10	25,94
[°C / °F]	-35	-31	116,0	396	99,8	0,49	1,66	0,42	238,4	2,63	3,16
cond. pressure	-23	-10	231,2	790	199,0	0,75	2,56	0,65	308,1	2,77	6,34
pc= 55/131	-15	5	354,3	1210	305,0	0,98	3,35	0,84	361,4	2,87	9,76
return gas temp	-9	15	459,1	1568	395,1	1,15	3,94	0,99	397,6	2,95	12,70
RGT= 32/90	-4	25	584,3	1995	502,8	1,35	4,60	1,16	433,8	3,02	16,25
liquid temp	0	32	685,1	2340	589,6	1,49	5,10	1,28	458,9	3,07	19,13
Tliq= 55/131	7,2	45	903,8	3087	777,8	1,79	6,12	1,54	504,3	3,16	25,48

Model

Designation	NF10FX	208-230V/60Hz	Conf. 3	Sales code:	105G6846
-------------	---------------	----------------------	----------------	-------------	-----------------

Configuration

Motor configuration	CSIR	
Power supply (nominal)	208-230V/60Hz 1~	
Refrigerant	R134a	
Application	LBP+MBP	
Voltage range	198-242V	
Starting torque	HST	
Approvals	UL	SA3693
	VDE	
	CCC	
	EAC	

Electrical accessories / wiring diagram

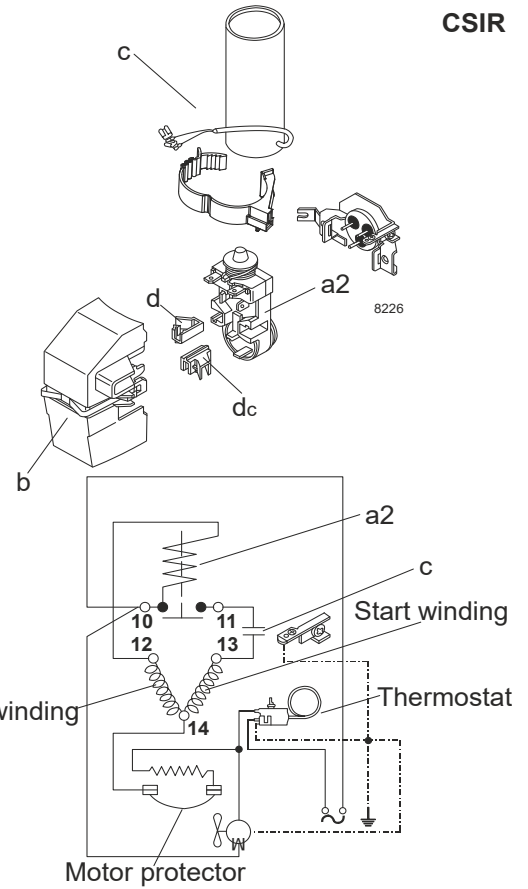

Ambient/ machine room temperatures minimum /maximum

Ambient temperature range:	10 - 38°C / 50 - 101°F
Machine room temperature range:	10 - 43°C / 50 - 110°F
Compressor cooling:	fan 3m/s

Operation pressure range

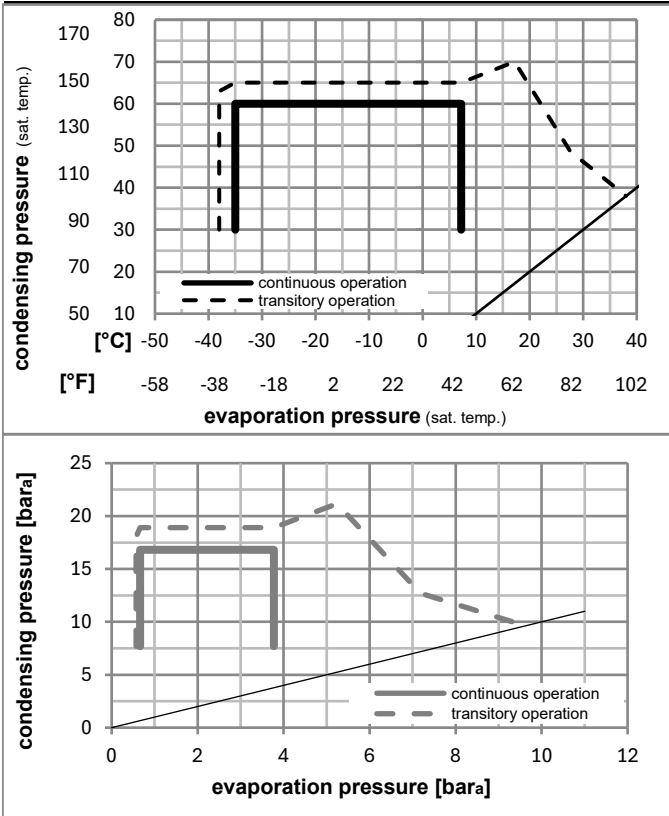

Components

a2	relay (protector: TI MRP56EN-6)	117U4139
c	start capacitor	117U5018
b	plastic cover	117U1021
d/dc	cord relief	117U0349
d/dc	cord relief	117U0349

Alternative components

a2	relay (protector: TI MRP56EN-6)	117U4139
c	start capacitor	117U5018
b	plastic cover	117U1021
d/dc	cord relief	117U0349
d	cord relief	117U0317

Model

Designation **NF10FX** **208-230V/60Hz** Conf. **3** Sales code: **105G6846**

Optimization + standard conditions

R134a, 230V/60Hz, CSIR, fan 3m/s, UL, VDE, CCC, EAC

	Evaporating pressure (saturation temperature)				Cooling capacity			COP	EER			Power consumption			ASHRAE LBP
	pe	pc	RGT	Tliq	[W]	[Btu/h]	[kcal/h]		[W/W]	[Btu/Wh]	[kcal/Wh]	P1	I	Ref. mass flow	
[°C]	-23	54	32	32	299,0	1021	257,4	1,14	3,90	0,98	262,0	1,86	5,81		
[°F]	-10	130	90	90											
[°C]	-25	55	32	55	223,1	762	192,0	0,89	3,03	0,76	251,1	1,82	5,33	cecomaf LBP	
[°F]	-13	131	90	131											
[°C]	-35	40	20	40	157,5	538	135,5	0,92	3,14	0,79	171,0	1,67	3,46	EN12900 LBP	
[°F]	-31	104	68	104											
[°C]	-7	54	35	46	584,8	1997	503,3	1,53	5,23	1,32	381,6	2,27	12,76	ASHRAE MBP	
[°F]	20	130	95	115											
[°C]	-10	55	32	55	455,7	1556	392,2	1,28	4,37	1,10	356,6	2,18	11,02	cecomaf MBP	
[°F]	14	131	90	131											
[°C]	-10	45	20	45	505,0	1725	434,6	1,48	5,07	1,28	340,3	2,12	11,82	EN12900 MBP	
[°F]	14	113	68	113											

Performance tables

R134a, 230V/60Hz, CSIR, fan 3m/s, UL, VDE, CCC, EAC

	pe		Cooling capacity			COP	EER		P1	I	m
	[°C]	[°F]	[W]	[Btu/h]	[kcal/h]	[W/W]	[Btu/Wh]	[kcal/Wh]	[W]	[A]	[kg/h]
[°C / °F]	-35	-31	144,8	495	124,6	0,83	2,83	0,71	174,7	1,66	3,12
cond. pressure	-23	-10	276,5	944	238,0	1,08	3,70	0,93	255,5	1,84	6,00
pc= 45/113	-15	5	415,1	1418	357,3	1,35	4,60	1,16	308,5	2,01	9,05
return gas temp.	-9	15	537,4	1835	462,5	1,56	5,34	1,34	343,9	2,13	11,77
RGT= 32/90	-4	25	689,2	2354	593,2	1,81	6,18	1,56	381,0	2,26	15,17
liquid temp	0	32	815,7	2786	702,0	2,00	6,82	1,72	408,5	2,36	18,04
Tliq= 45/113	7,2	45	1100,9	3760	947,4	2,37	8,09	2,04	465,0	2,56	24,59
[°C / °F]	-35	-31	121,9	416	104,9	0,67	2,28	0,57	182,6	1,62	2,90
cond. pressure	-23	-10	242,9	830	209,1	0,93	3,16	0,80	262,3	1,86	5,81
pc= 55/131	-15	5	362,7	1239	312,1	1,13	3,87	0,98	319,8	2,05	8,73
return gas temp	-9	15	467,3	1596	402,1	1,30	4,42	1,11	360,8	2,20	11,30
RGT= 32/90	-4	25	597,2	2040	514,0	1,47	5,03	1,27	405,3	2,35	14,54
liquid temp	0	32	705,9	2411	607,5	1,61	5,49	1,38	439,3	2,47	17,27
Tliq= 55/131	7,2	45	952,7	3254	819,9	1,87	6,38	1,61	510,2	2,70	23,56

Model

Designation	NF10FX	208-230V/60Hz	Conf. 4	Sales code:	105G6846
-------------	---------------	----------------------	----------------	-------------	-----------------

Configuration

Motor configuration	CSIR	
Power supply (nominal)	208-230V/60Hz 1~	
Refrigerant	R513A	
Application	LBP+MBP	
Voltage range	198-242V	
Starting torque	HST	
Approvals	UL	SA3693
	VDE	
	CCC	
	EAC	

Electrical accessories / wiring diagram

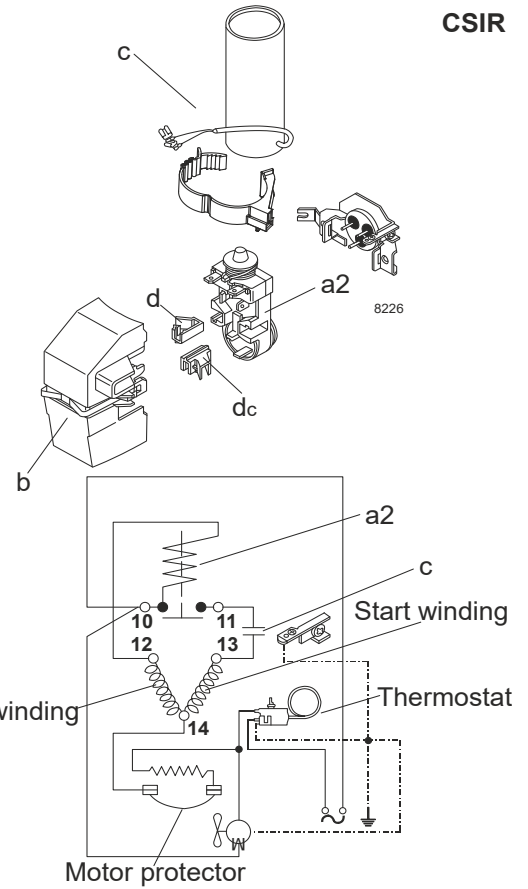

Ambient/ machine room temperatures minimum /maximum

Ambient temperature range:	10 - 38°C / 50 - 101°F
Machine room temperature range:	10 - 43°C / 50 - 110°F
Compressor cooling:	fan 3m/s

Operation pressure range

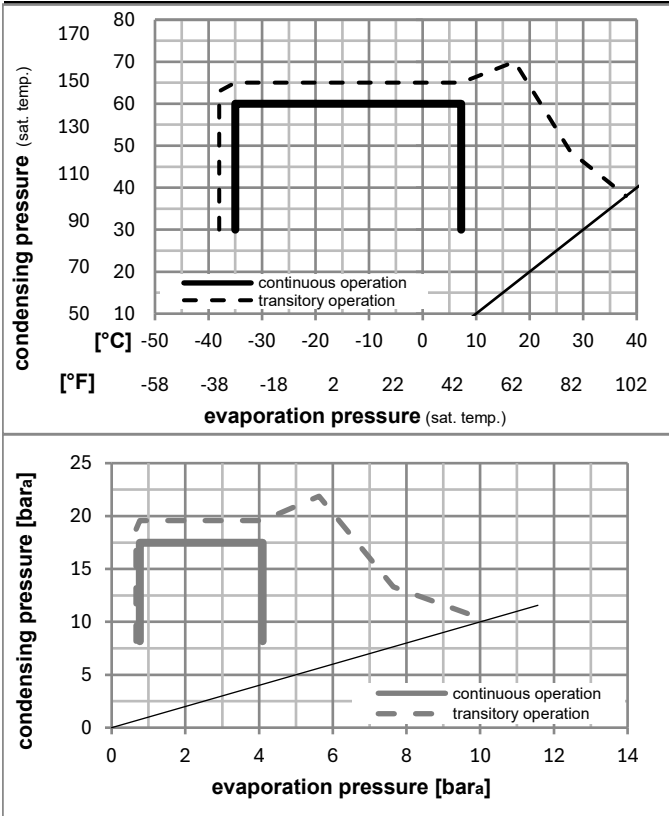

Components

a2	relay (protector: TI MRP56EN-6)	117U4139
c	start capacitor	117U5018
b	plastic cover	117U1021
d/dc	cord relief	117U0349
d/dc	cord relief	117U0349

Alternative components

a2	relay (protector: TI MRP56EN-6)	117U4139
c	start capacitor	117U5018
b	plastic cover	117U1021
d/dc	cord relief	117U0349
d	cord relief	117U0317

Model

Designation **NF10FX** **208-230V/60Hz** Conf. 4 Sales code: **105G6846**

Optimization + standard conditions

R513A, 230V/60Hz, CSIR, fan 3m/s, UL, VDE, CCC, EAC

	Evaporating pressure (saturation temperature)				Cooling capacity			COP	EER			Power consumption			ASHRAE LBP
	pe	pc	RGT	Tliq	[W]	[Btu/h]	[kcal/h]		[W/W]	[Btu/Wh]	[kcal/Wh]	P1	I	m	
[°C]	-23	54	32	32	330,1	1127	284,1	1,15	3,94	0,99	286,4	1,95	7,10		
[°F]	-10	130	90	90											
[°C]	-25	55	32	55	239,6	818	206,2	0,87	2,97	0,75	275,6	1,91	6,56	cecomaf LBP	
[°F]	-13	131	90	131											
[°C]	-35	40	20	40	176,3	602	151,7	0,93	3,18	0,80	189,6	1,63	4,36	EN12900 LBP	
[°F]	-31	104	68	104											
[°C]	-7	54	35	46	613,1	2094	527,7	1,51	5,15	1,30	406,4	2,34	15,02	ASHRAE MBP	
[°F]	20	130	95	115											
[°C]	-10	55	32	55	472,3	1613	406,4	1,24	4,23	1,07	381,4	2,26	13,06	cecomaf MBP	
[°F]	14	131	90	131											
[°C]	-10	45	20	45	527,3	1801	453,8	1,45	4,96	1,25	363,2	2,20	13,98	EN12900 MBP	
[°F]	14	113	68	113											

Performance tables

R513A, 230V/60Hz, CSIR, fan 3m/s, UL, VDE, CCC, EAC

	pe		Cooling capacity			COP			EER			P1			I			m		
	[°C]	[°F]	[W]	[Btu/h]	[kcal/h]	[W/W]	[Btu/Wh]	[kcal/Wh]	[W]	[A]	[kg/h]	[W]	[A]	[kg/h]	[W]	[A]	[kg/h]	[W]	[A]	[kg/h]
[°C / °F]	-35	-31	163,6	559	140,8	0,84	2,87	0,72	194,6	1,64	3,97									
cond. pressure	-23	-10	299,1	1021	257,4	1,08	3,68	0,93	277,7	1,92	7,30									
pc= 45/113	-15	5	440,9	1506	379,4	1,33	4,55	1,15	331,3	2,10	10,80									
return gas temp.	-9	15	565,1	1930	486,3	1,54	5,26	1,33	366,8	2,21	13,90									
RGT= 32/90	-4	25	718,2	2453	618,1	1,78	6,07	1,53	403,9	2,33	17,75									
liquid temp	0	32	845,2	2886	727,4	1,96	6,69	1,69	431,5	2,43	20,96									
Tliq= 45/113	7,2	45	1130,0	3859	972,5	2,32	7,91	1,99	488,0	2,61	28,26									
[°C / °F]	-35	-31	137,5	469	118,3	0,67	2,28	0,57	206,0	1,68	3,75									
cond. pressure	-23	-10	259,6	887	223,4	0,90	3,09	0,78	286,9	1,95	7,12									
pc= 55/131	-15	5	379,7	1297	326,8	1,10	3,76	0,95	344,6	2,14	10,46									
return gas temp	-9	15	483,7	1652	416,3	1,25	4,28	1,08	385,7	2,27	13,38									
RGT= 32/90	-4	25	612,2	2091	526,9	1,42	4,86	1,22	430,4	2,42	17,02									
liquid temp	0	32	719,2	2456	619,0	1,55	5,29	1,33	464,6	2,54	20,09									
Tliq= 55/131	7,2	45	961,2	3283	827,2	1,79	6,12	1,54	536,1	2,77	27,10									



NF Compressors





8238-23



Secop accepts no responsibility for possible errors in catalogs, brochures, and other printed material. Secop reserves the right to alter its products without notice. This also applies to products already on order provided that such alterations can be made without subsequential changes being necessary to specifications already agreed. All trademarks in this material are the property of the respective companies. Secop and the Secop logotype are trademarks of Secop GmbH. All rights reserved. www.secop.com