

Single Pack TLES8.7KK.3 220-240V 50Hz RSIR

Single pack code number: **195B4126**

Position	Title	Code	Amount
1	Compressor TLES8.7KK.3	102H4938	1
2	PTC starting device (220V, 250hm, 6.3mm)	103N0011	1
3	Protection screen for PTC	103N0476	1
4	Cord relief	103N1010	1
5	Cover	103N2010	1
6	Bolt joint for one compressor M6 ø16mm	118-1917	1

Secop GmbH • Lise-Meitner-Straße 29 • 24941 Flensburg, Germany • Tel: +49 461 4941 0 • www.secop.com

Secop accepts no responsibility for possible errors in catalogs, brochures, and other printed material. Secop reserves the right to alter its products without notice. This also applies to products already on order provided that such alterations can be made without subsequent changes being necessary to specifications already agreed. All trademarks in this material are the property of the respective companies. Secop and the Secop logotype are trademarks of Secop GmbH. All rights reserved.

TLES8.7KK.3 Energy-optimized Compressor R600a 220-240V 50Hz

General

Code number	102H4938
Approvals	EN 60335-2-34 with Annex AA
Compressors on pallet	125

Application

Application	LBP		
Frequency	Hz	50	60
Evaporating temperature	°C	-35 to -10	-
Voltage range	V	198 - 254	-
Max. condensing temperature continuous (short)	°C	60 (70)	-
Max. winding temperature continuous (short)	°C	125 (135)	-

Cooling requirements

Frequency	Hz	50			60		
Application		LBP	MBP	HBP	LBP	MBP	HBP
32°C		S	-	-	-	-	-
38°C		S	-	-	-	-	-
43°C		S	-	-	-	-	-
Remarks on application:							

Motor

Motor type	RSIR/RSCR		
LRA (rated after 4 sec. UL984), HST LST	A	-	4.2
Cut in Current, HST LST	A	-	8.4
Resistance, main start winding (25°C)	Ω	17.9	17.7

Design

Displacement	cm ³	8.67
Oil quantity (type)	cm ³	180 (mineral)
Maximum refrigerant charge	g	150
Free gas volume in compressor	cm ³	1690
Weight without electrical equipment	kg	6.8

Dimensions

Height	mm	A	163
		B	159
		B1	-
		B2	-
Suction connector	location/I.D. mm angle	C	6.2 30°
	material comment		Cu-plated steel Al cap
Process connector	location/I.D. mm angle	D	6.2 31.5°
	material comment		Cu-plated steel Al cap
Discharge connector	location/I.D. mm angle	E	5.0 28°
	material comment		Cu-plated steel Al cap
Oil cooler connector	location/I.D. mm angle	F	-
	material comment		-
Connector tolerance	I.D. mm		±0.09, on 5.0 +0.12/+0.20
Remarks:			

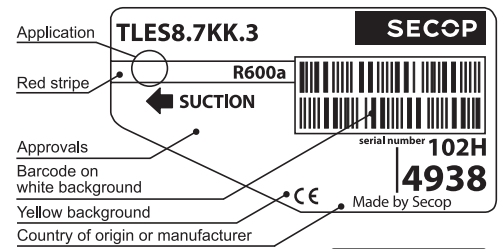

- S = Static cooling normally sufficient
- O = Oil cooling
- F₁ = Fan cooling 1.5 m/s (compressor compartment temperature equal to ambient temperature)
- F₂ = Fan cooling 3.0 m/s necessary
- SG = Suction gas cooling normally sufficient
- = not applicable in this area

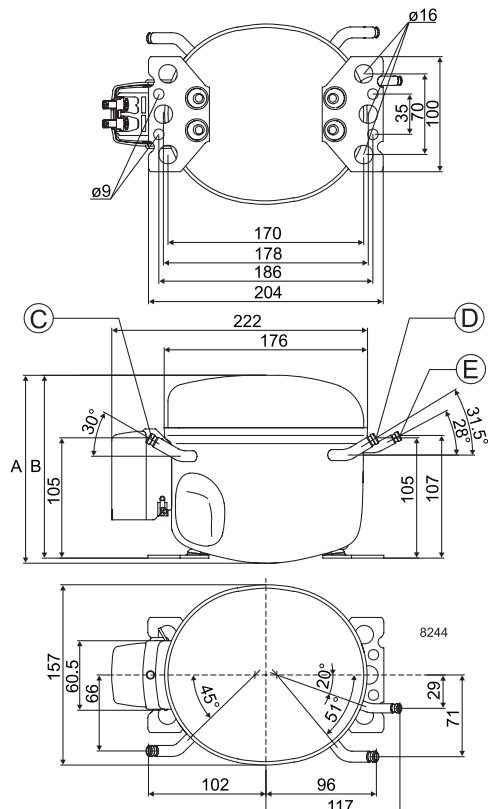

EN 12900 Household (CECOMAF) 220V, 50Hz, 2 W PTC consumption incl., static cooling

Evap. temp in °C	-45	-40	-35	-30	-25	-23.3	-20	-15	-10	-6.7	-5	0	5	7.2	10	15	20
Capacity in W			61.6	83.3	110	120	143	181	228								
Power cons. in W			80.8	93.8	107	111	120	133	149								
Current cons. in A			0.78	0.82	0.86	0.87	0.90	0.94	0.99								
COP in W/W			0.76	0.89	1.03	1.09	1.19	1.36	1.53								

EN 12900 Household (CECOMAF) 220V, 50Hz, RC 4µF, 2 W PTC consumption incl., static cooling

Evap. temp in °C	-45	-40	-35	-30	-25	-23.3	-20	-15	-10	-6.7	-5	0	5	7.2	10	15	20
Capacity in W			61.6	83.3	110	120	143	181	228								
Power cons. in W			77.1	89.5	102	106	114	127	142								
Current cons. in A			0.53	0.58	0.62	0.63	0.66	0.71	0.75								
COP in W/W			0.80	0.93	1.08	1.14	1.25	1.43	1.61								

ASHRAE LBP 220V, 50Hz, 2 W PTC consumption incl., static cooling

Evap. temp in °C	-45	-40	-35	-30	-25	-23.3	-20	-15	-10	-6.7	-5	0	5	7.2	10	15	20
Capacity in W			75.3	102	134	147	174	222	278								
Power cons. in W			81.0	93.8	106	111	119	133	148								
Current cons. in A			0.78	0.82	0.86	0.87	0.90	0.94	0.98								
COP in W/W			0.93	1.09	1.26	1.33	1.46	1.67	1.88								

ASHRAE LBP 220V, 50Hz, RC 4µF, 2 W PTC consumption incl., static cooling

Evap. temp in °C	-45	-40	-35	-30	-25	-23.3	-20	-15	-10	-6.7	-5	0	5	7.2	10	15	20
Capacity in W			75.3	102	134	147	174	222	278								
Power cons. in W			77.3	89.4	101	105	114	127	141								
Current cons. in A			0.54	0.58	0.62	0.63	0.66	0.70	0.75								
COP in W/W			0.97	1.14	1.33	1.39	1.53	1.75	1.97								

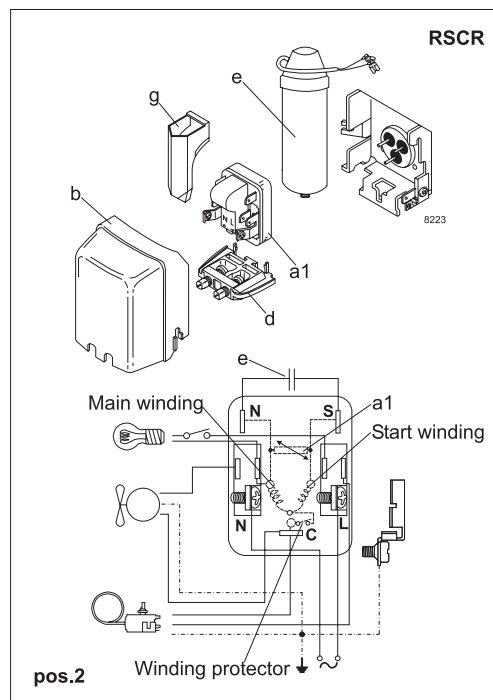
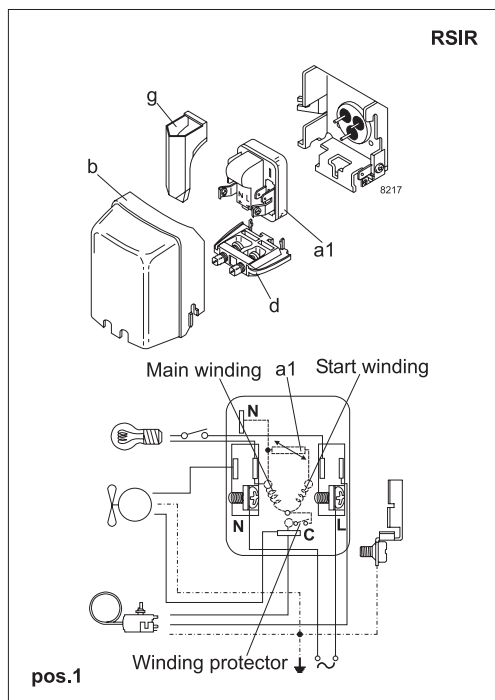

Accessories for	TLES8.7KK.3	Figure	Code number
PTC starting device	6.3 mm spade connectors	a1 (pos.1)	103N0011
	4.8 mm spade connectors		103N0018
PTC starting device	6.3 mm spade connectors	a1 (pos.2)	103N0016
	4.8 mm spade connectors		103N0021
ePTC starting device	4.8 mm spade connectors		103N0050
Cover		b	103N2010
Cord relief		d	103N1010
Run capacitor 4 µF (optional)	6.3 mm spade connectors	e	117-7117
	4.8 mm spade connectors		117-7119
Protection screen for PTC		g	103N0476

Test conditions	EN 12900/ CECOMAF	ASHRAE
Condensing temperature	55°C	54.4°C
Ambient temperature	32°C	32°C
Suction gas temperature	32°C	32°C
Liquid temperature	no subcooling	32°C

Mounting accessories	Code number	
Bolt joint for one comp.	Ø: 16 mm	118-1917
Bolt joint in quantities	Ø: 16 mm	118-1918
Snap-on in quantities	Ø: 16 mm	118-1919

Secop accepts no responsibility for possible errors in catalogs, brochures, and other printed material. Secop reserves the right to alter its products without notice. This also applies to products already on order provided that such alterations can be made without consequential changes being necessary to specifications already agreed. All trademarks in this material are the property of the respective companies. Secop and the Secop logotype are trademarks of Secop GmbH. All rights reserved. www.secop.com



TL Compressors

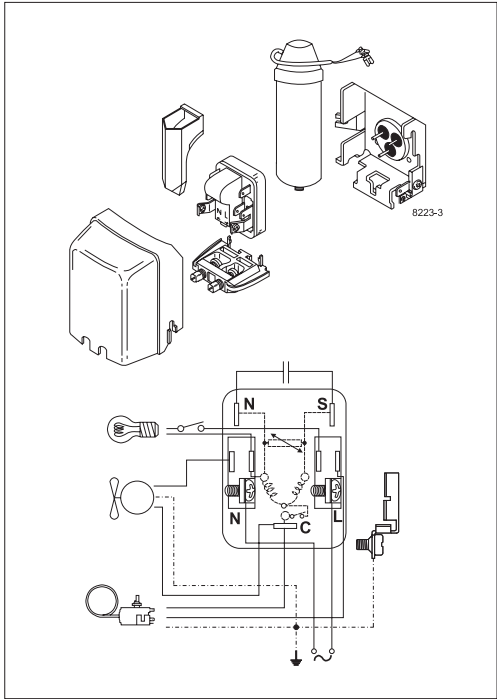



Service/Repair – R600a, R290



8545

Brazing on Suction Connectors (Direct Intake)

representative image



**! max. 150°C/302°F !
at socket**
brazing solder: phosphor (LP7) or silver

Refer to Product Bulletin:
**Brazing on Suction Connectors
(Compressors with Direct Suction Intake)**

Secop accepts no responsibility for possible errors in catalogs, brochures, and other printed material. Secop reserves the right to alter its products without notice. This also applies to products already on order provided that such alterations can be made without subsequential changes being necessary to specifications already agreed. All trademarks in this material are the property of the respective companies. Secop and the Secop logotype are trademarks of Secop GmbH. All rights reserved. www.secop.com