

Single Pack HXK95AA 220-240V 50Hz RSCR

Single pack code number: **195B4609**

Position	Title	Code	Amount
1	Compressor HXK95AA	16348100	1
2	Screw for cable clamp	10636000	1
3	Screw for cable clamp	10636200	1
4	Cover	10636401	1
5	Rubber grommet 16.5mm	10639900	4
6	Sleeve	10640100	4
7	Earth screw	10641201	1
8	Run capacitor (4 μ F 420V, 4.8mm)	11261700	1
9	Cable clamp	11341000	1
10	Terminal board 4.8mm	15163500	1

Secop GmbH • Lise-Meitner-Straße 29 • 24941 Flensburg, Germany • Tel: +49 461 4941 0 • www.secop.com

Secop accepts no responsibility for possible errors in catalogs, brochures, and other printed material. Secop reserves the right to alter its products without notice. This also applies to products already on order provided that such alterations can be made without subsequent changes being necessary to specifications already agreed. All trademarks in this material are the property of the respective companies. Secop and the Secop logotype are trademarks of Secop GmbH. All rights reserved.

Model

Designation	HXK95AA	220-240V/50Hz 1~	Sales code:	16348100
-------------	----------------	------------------	-------------	-----------------

Compressor design

Oil type	Mineral	Refrigerant(s)	R600a
Oil viscosity	5cST	Displacement	9,6cm ³ / 0,59cu.in
Oil quantity	162cm ³ / 5,5fl.oz	Compressors on pallet	100
Refr. charge - tech. limit	150g / 5,3oz		
Free gas volume comp.	1560cm ³ / 52,7fl.oz		
Weight	9,3kg / 20,5lbs		
Motor protection	external		
Winding resistance main	22,4Ω (at 25°C)		
Winding resistance aux	15,3Ω (at 25°C)		
Max. winding temp.	130°C / 266°F		
Max. discharge temp.	130°C / 266°F		



General - Configurations with HXK95AA

	Conf. 1
Motorconfiguration	RSCR
Power supply (nominal)	220-240V/50Hz
Number of phases	1
Voltage range	187-264V
Approvals	VDE
Starting torque	LST
Note	Various options of connectors are possible - please contact SECOP-Sales.

Applications with HXK95AA

	Conf. 1
Refrigerant	R600a
Application	LBP
System cooling	static
Hot gas defrost	-/-
Long interval pull down	-/-

Electrical data - Configurations with HXK95AA

	Conf. 1
Starting device type	PTC
Run capacitor	4μF
Start capacitor	-/-
LRA (locked rotor amps / 4s/ U(N))	
RLA (rated load amps / 1s/ U(N))	-/-A
Cut in current (U(N))	

Model

Designation	HXK95AA	220-240V/50Hz 1~	Sales code:	16348100
-------------	----------------	------------------	-------------	-----------------

Compressor dimensions

Housing	A Height	174mm / 6,85in
	B Height	167mm / 6,57in
	C Length shell	194mm / 7,64in
	D Length w. cover	238mm / 9,37in
	E Width	151mm / 5,94in

Connectors		Suction	Discharge	Process
		X	Y	Z
Diameter	[mm]	øi 6,1-6,2	øi 5,1-5,2	#NV
	(i:inside, o:outside) [in]	øi 0,24-0,24	øi 0,2-0,2	#NV
Material		copper	copper	#NV
Horizontal angle	±2°	45°	13°	0°
Vertical angle	±2°	35°	40°	145°
Position l/h/w	[mm]	120/72/62	112/106/62	-140/136/70
	[in]	4,7/2,8/2,4	4,4/4,2/2,4	-5,5/5,4/2,8
Straight tube l.	[mm]	14	14	#NV
	[in]	0,5	0,5	#NV



Compressor fixation

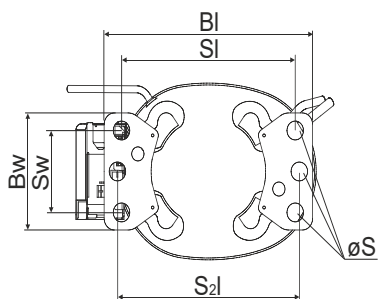

Baseplate	[mm]	[inch]
BI	204	8.03
BW	100	3.94
Small holes		
	[mm]	[inch]
SI	170	6.7
SW	70	2.76
S2l	178	7
øS	ø 16	ø 0.63

Bolt joint

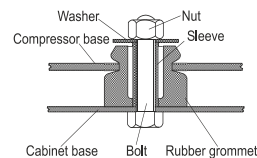

Snap-on

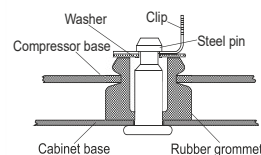

Mounting accessories

'4ZN' with rubber grommet	order code	772N
'4ZN' with rubber grommet and sleeve for M6		768N
Bolt joint kit		4ZN + 118-1917 (18)
'4ZN' with Snap on kit		776N

Application notes

Provision for PE Grounding is located at the PE Stamp on the compressor Housing with dip-tray fixture (omega bracket).
 Various options of connectors are possible - please contact SECOP-Sales.

Model

Designation	HXK95AA	220-240V/50Hz	Conf. 1	Sales code:	16348100
-------------	----------------	----------------------	---------	-------------	-----------------

Configuration

Motorconfiguration	RSCR
Power supply (nominal)	220-240V/50Hz 1~
Refrigerant	R600a
Application	LBP
Voltage range	187-264V
Starting torque	LST
Approvals	VDE

Electrical accessories / wiring diagram

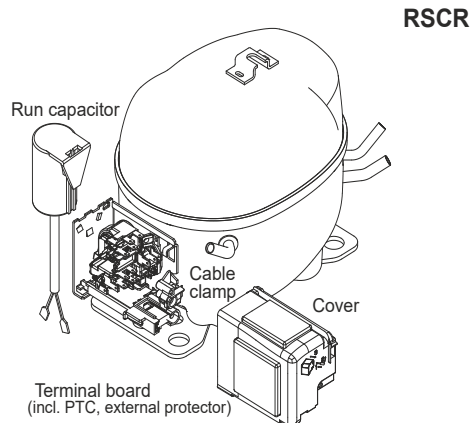

Ambient/ machine room temperatures minimum /maximum

Ambient temperature range:	10 - 43°C / 50 - 110°F
Machine room temperature range:	10 - 48°C / 50 - 119°F
Compressor cooling:	static

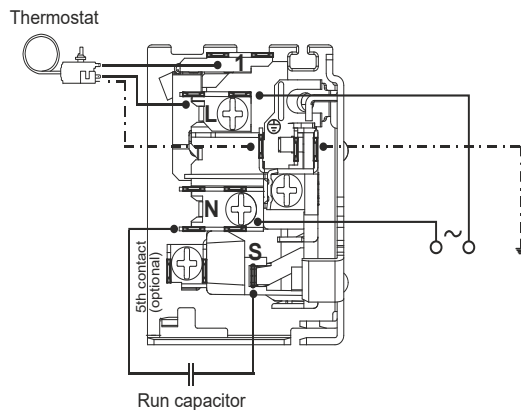

Operation pressure range

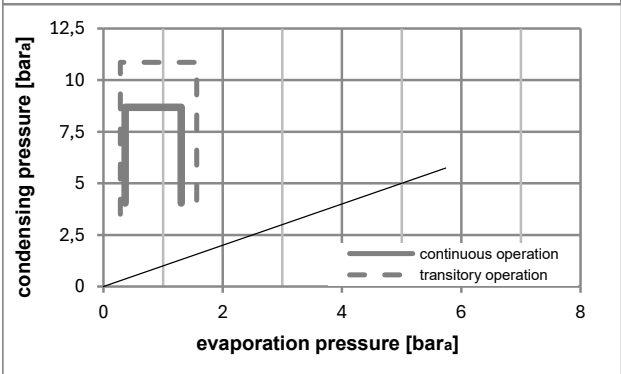
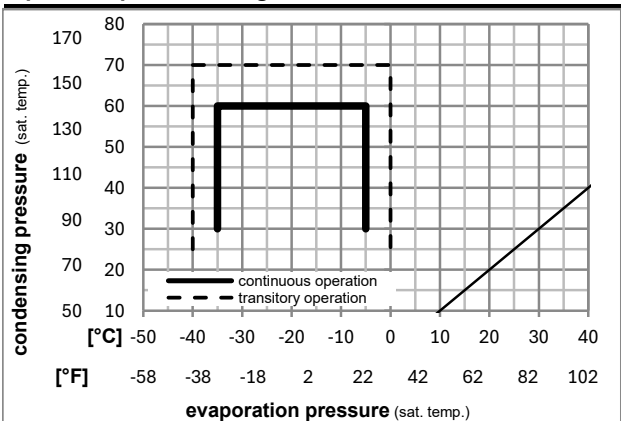

Components

. terminal board (PTC, 4.8mm)	15163500
. run capacitor (4μF, 4.8mm)	11261700
b cover terminal board	10636401
. cable clamp	11341000
. screw - uni6954	10636000
. screw - uni6954	10636200

Alternative components

. terminal board (PTC, 6.3mm)	15279300
. run capacitor (4μF, 6.3mm)	15186801
. screw uni en iso 4757	10641201

Model

Designation	HXK95AA	220-240V/50Hz	Conf. 1	Sales code:	16348100
-------------	----------------	----------------------	---------	-------------	-----------------

Optimization + standard conditions

R600a, 220V/50Hz, RSCR, static, VDE

		Evaporating pressure (saturation temperature)				Condensing pressure (saturation temperature)			Return gas temp.		Liquid temp.		Cooling capacity			COP	EER	Power consumption		Current consumption		Ref. mass flow	
		pe	pc	RGT	Tliq	[W]	[Btu/h]	[kcal/h]	[W/W]	[Btu/Wh]	[kcal/Wh]	[W]	[A]	[kg/h]			P1	I	m				
[°C]	[°F]	[°C]	[°F]	[°C]	[°F]																		
-23	-10	54	130	32	90	171,0	584	147,2	1,91	6,52	1,64	89,5	0,40	1,84								ASHRAE LBP	
-25	-13	55	131	32	90	128,6	439	110,7	1,50	5,13	1,29	85,6	0,39	1,68								cecomaf LBP	
-35	-31	40	104	20	68	87,8	300	75,5	1,42	4,87	1,23	61,6	0,31	1,07								EN12900 LBP	
-23	-10	49	120	4,4	40	139,1	475	119,8	1,59	5,42	1,37	87,7	0,39	2,03								ARI540 LBP	
-23	-10	41	105	32	90	184,2	629	158,5	2,16	7,36	1,86	85,4	0,38	1,98								AHAM LBP	
-35	-31	45	113	32	90	84,5	288	72,7	1,36	4,63	1,17	62,3	0,31	1,00								opt	

Performance tables

R600a, 220V/50Hz, RSCR, static, VDE

	pe		Cooling capacity			COP	EER	P1	I	m	
	[°C]	[°F]	[W]	[Btu/h]	[kcal/h]	[W/W]	[Btu/Wh]	[kcal/Wh]	[W]	[A]	[kg/h]
[°C / °F]	-35	-31	84,5	288	72,7	1,36	4,63	1,17	62,3	0,31	1,00
cond. pressure	-30	-22	113,9	389	98,0	1,58	5,40	1,36	72,1	0,34	1,35
pc= 45/113	-25	-13	149,1	509	128,4	1,80	6,15	1,55	82,8	0,37	1,78
return gas temp.	-23	-10	162,4	555	139,8	1,88	6,41	1,61	86,6	0,38	1,93
RGT= 32/90	-20	-4	190,0	649	163,5	2,02	6,90	1,74	94,0	0,41	2,27
liquid temp	-15	5	236,4	807	203,5	2,24	7,65	1,93	105,5	0,44	2,82
Tliq= 45/113	-5	23	345,3	1179	297,2	2,70	9,21	2,32	128,0	0,55	4,15
[°C / °F]	-35	-31	72,9	249	62,7	1,14	3,89	0,98	64,0	0,32	0,95
cond. pressure	-30	-22	97,7	334	84,1	1,32	4,50	1,13	74,1	0,35	1,27
pc= 55/131	-25	-13	128,6	439	110,7	1,50	5,13	1,29	85,6	0,39	1,68
return gas temp	-23	-10	140,5	480	120,9	1,56	5,34	1,35	89,8	0,40	1,83
RGT= 32/90	-20	-4	165,6	565	142,5	1,68	5,75	1,45	98,3	0,43	2,16
liquid temp	-15	5	208,5	712	179,4	1,87	6,37	1,61	111,8	0,47	2,73
Tliq= 55/131	-5	23	311,6	1064	268,2	2,22	7,59	1,91	140,2	0,59	4,10



K-Series Compressors

GTK, HKK, HMK, HTK, HXK, HZK



Service/Repair – R600a

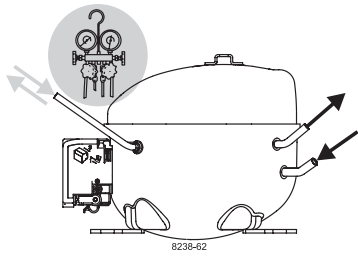

K-Series Compressors

GTK, HKK, HMK, HTK, HXK, HZK

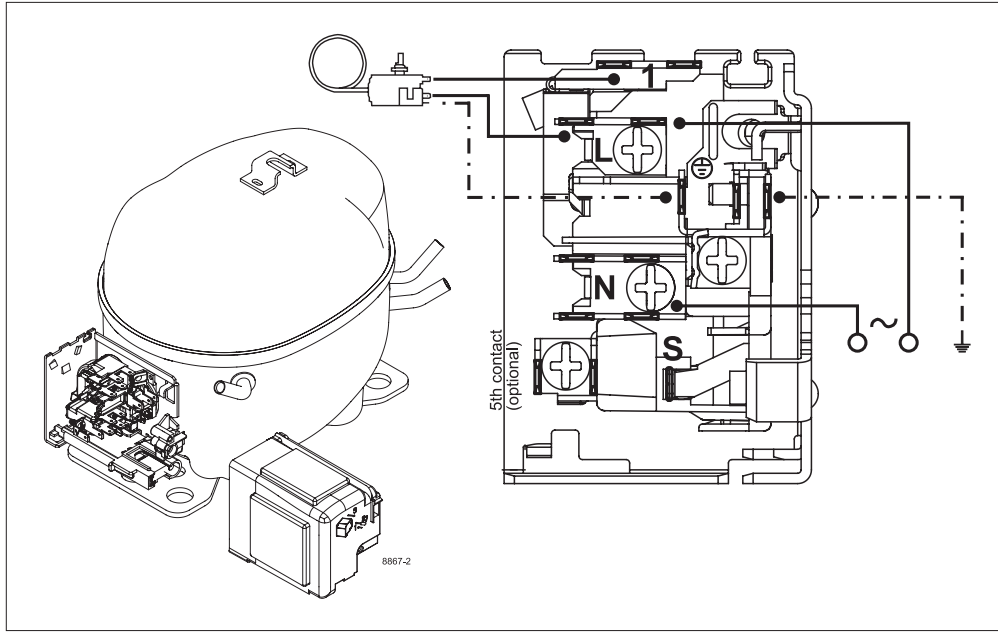

Service/Repair – R600a

Secop accepts no responsibility for possible errors in catalogs, brochures, and other printed material. Secop reserves the right to alter its products without notice. This also applies to products already on order provided that such alterations can be made without subsequential changes being necessary to specifications already agreed. All trademarks in this material are the property of the respective companies. Secop and the Secop logotype are trademarks of Secop GmbH. All rights reserved. www.secop.com