

## Single Pack SC12/12DL 220-240V 50Hz CSIR

Single pack code number: **195B3086**

Position	Title	Code	Amount
1	Compressor SC12/12DL	104L4092	1
2	Starting relay	117U6019	2
3	Starting capacitor (80 $\mu$ F 220V, 6.3mm)	117U5017	2
4	Cover	103N2009	2
5	Cord relief	103N1004	2
6	Bolt joint for one compressor   M6   $\varnothing$ 16mm	118-1917	2

Secop GmbH • Lise-Meitner-Straße 29 • 24941 Flensburg, Germany • Tel: +49 461 4941 0 • [www.secop.com](http://www.secop.com)

Secop accepts no responsibility for possible errors in catalogs, brochures, and other printed material. Secop reserves the right to alter its products without notice. This also applies to products already on order provided that such alterations can be made without subsequent changes being necessary to specifications already agreed. All trademarks in this material are the property of the respective companies. Secop and the Secop logotype are trademarks of Secop GmbH. All rights reserved.

## Model

Designation	<b>SC12/12DL</b>	220-240V/50Hz 1~	Sales code:	<b>104L4092</b>
-------------	------------------	------------------	-------------	-----------------

## Compressor design

Oil type	Polyolester	Refrigerant(s)	<b>R404A, R507, R407C</b>
Oil viscosity	32cST	Displacement	25,74cm <sup>3</sup> / 1,57cu.in
Oil quantity	1233cm <sup>3</sup> / 41,7fl.oz	Compressors on pallet	18
Refr. charge - tech. limit	2200g / 77,6oz		
Free gas volume comp.	2920cm <sup>3</sup> / 98,7fl.oz		
Weight	27,8kg / 61,3lbs		
Motor protection	1# internal		
Winding resistance main	3,7Ω (at 25°C)		
Winding resistance aux	14Ω (at 25°C)		
Max. winding temp.	125°C / 257°F		
Max. discharge temp.	135°C / 275°F		



## General - Configurations with SC12/12DL

	<b>Conf. 1</b>	<b>Conf. 2</b>
Motorconfiguration	CSIR	CSIR
Power supply (nominal)	220-240V/50Hz	220-240V/50Hz
Number of phases	1	1
Voltage range	198-254V	198-254V
Approvals	CCC, EAC, VDE	CCC, EAC, VDE
Starting torque	HST	HST
Note	- / -	

## Applications with SC12/12DL

	<b>Conf. 1</b>	<b>Conf. 2</b>
Refrigerant	R404A	R407C
Application	HBP	HBP
System cooling	fan 3m/s	fan 3m/s
Hot gas defrost	OK	OK
Long interval pull down	OK	OK

## Electrical data - Configurations with SC12/12DL

	<b>Conf. 1</b>	<b>Conf. 2</b>
Starting device type	relay	relay
Run capacitor	- / -	- / -
Start capacitor	80μF	80μF
LRA (locked rotor amps / 4s)	2x 23,4A	2x 23,4A
RLA (rated load amps / 1s)	2x 4,3A	2x 4,3A
Cut in current	2x 23,4A	2x 23,4A

## Model

Designation	<b>SC12/12DL</b>	220-240V/50Hz 1~	Sales code:	<b>104L4092</b>
-------------	------------------	------------------	-------------	-----------------

## Compressor dimensions

<b>Housing</b>	A Height	259mm / 10,2in
	B Height	254mm / 10in
	B1	193mm / 7,6in
	B2	110mm / 4,33in

Connectors		Suction	Discharge	Process
		C	E	D
Diameter	[mm]	øi 15,21-15,37	øi 6,11-6,29	øi 6,11-6,29
(i:inside, o:outside)	[in]	øi 0,6-0,61	øi 0,24-0,25	øi 0,24-0,25
Material		steel	copper	copper
Horizontal angle	±2°	0°	37°	37°
Vertical angle	±2°	0°	0°	0°
Position l/h/w	[mm]	0/0/0	0/0/0	0/0/0
	[in]	0/0/0	0/0/0	0/0/0
Straight tube l.	[mm]	10	12	12
	[in]	0,4	0,5	0,5

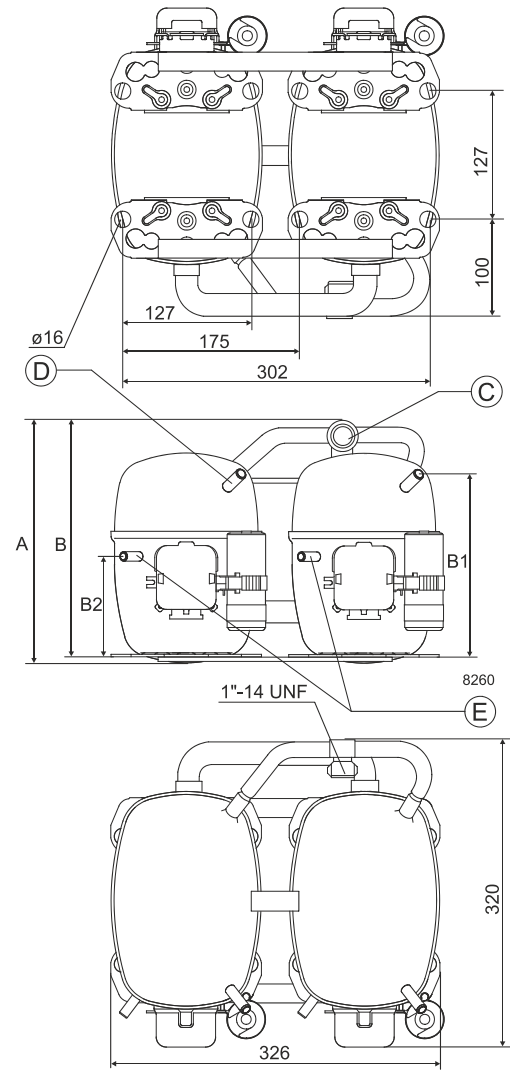

## Compressor fixation

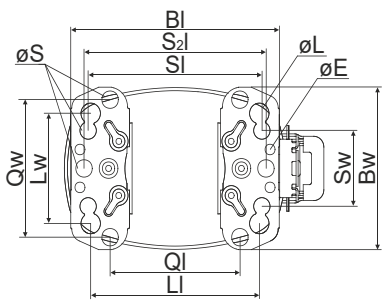

Baseplate	[mm]	[inch]
BI	204	8.03
Bw	150	5.9
øE	ø 9.7	ø 0.38
Large holes		
LI	165	6.5
Lw	101.6	4
øL	ø 19	ø 0.75
Small holes		
SI	170	6.7
Sw	70	2.76
øS	ø 16	ø 0.63
QI	127	5
Qw	127	5

## Mounting accessories

	one comp.	multi pack
Bolt joint   M6   ø16mm	118-1917	118-1918
Bolt joint   ø1/4"   ø16mm	118-1946	
Bolt joint   ø1/4"   ø19mm	118-1949	
Snap-on   ø7,3   ø16mm	118-1947	118-1919

### Bolt joint

### Snap-on

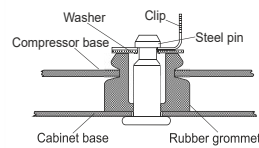
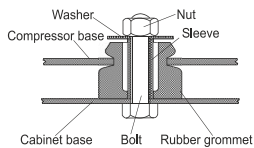

## Application notes

Provision for PE Grounding is located at the PE Stamp on the compressor  
 Twin should be used with a time-delay relay

## Model

Designation	<b>SC12/12DL</b>	<b>220-240V/50Hz</b>	<b>Conf. 1</b>	Sales code:	<b>104L4092</b>
-------------	------------------	----------------------	----------------	-------------	-----------------

## Configuration

Motorconfiguration	CSIR
Power supply (nominal)	220-240V/50Hz 1~
Refrigerant	R404A
Application	HBP
Voltage range	198-254V
Starting torque	HST
Approvals	CCC, EAC, VDE

## Ambient/ machine room temperatures minimum /maximum

Ambient temperature range:	10 - 38°C / 50 - 101°F
Machine room temperature range:	10 - 43°C / 50 - 110°F
Compressor cooling:	fan 3m/s

## Operation Limits

## Electrical accessories / wiring diagram



## Operation pressure range

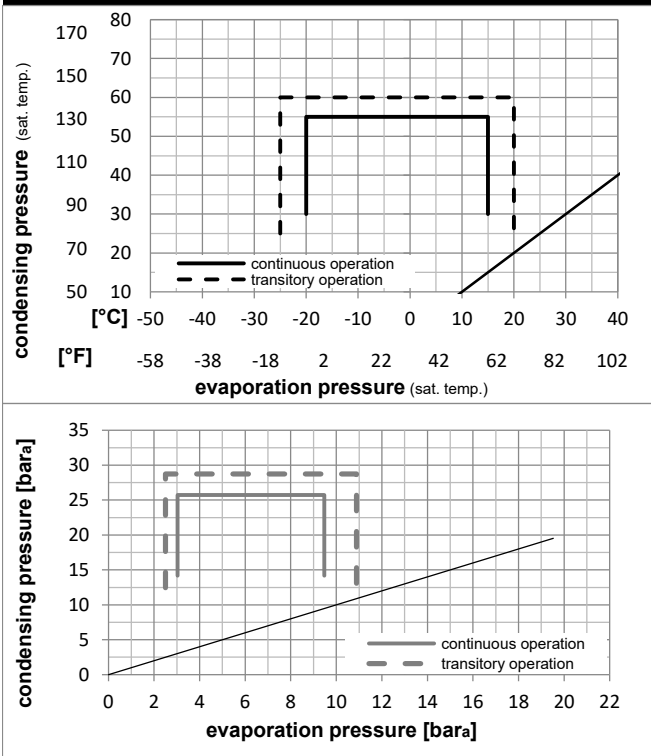

## Components

a2	relay	117U6019
c	start capacitor (80µF)	117U5017
d	cord relief	103N1004
b	plastic cover	103N2009
.	Check valve (to be used with time-delay relay)	020-1014
.	Service valve 12mm	118-7350
.	Solder connector (alternative) 12 mm	104B0584
.	Seal ring for service valve and solder conn.	118-3638

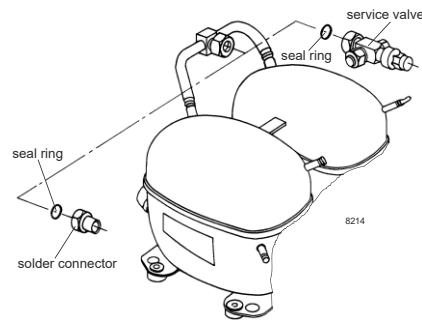

## Model

Designation	<b>SC12/12DL</b>	<b>220-240V/50Hz</b>	Conf. 1	Sales code:	<b>104L4092</b>
-------------	------------------	----------------------	---------	-------------	-----------------

## Optimization + standard conditions

R404A, 220V/50Hz, CSIR, fan 3m/s, CCC, EAC, VDE

	Evaporating pressure (saturation temperature)				Cooling capacity			COP	EER	P1	Power consumption		Ref. mass flow				
	pe	pc	RGT	Tliq	[W]	[Btu/h]	[kcal/h]				I	m					
	[°C]	[°F]	[°C]	[°F]	[W]	[Btu/h]	[kcal/h]	[W/W]	[Btu/WWh]	[kcal/WWh]	[W]	[A]	[kg/h]				
ASHRAE HBP	7,2	45	54	130	35	95	46	115	3885,8	13271	3344,1	2,26	7,71	1,94	1720,4	9,84	110,49
cecomaf HBP	5	41	55	131	32	90	55	131	3051,7	10422	2626,3	1,80	6,15	1,55	1695,0	9,71	101,63
EN12900 HBP	5	41	50	122	20	68	50	122	3166,7	10815	2725,3	1,99	6,78	1,71	1594,7	9,29	108,00
ASHRAE MBP	-7	20	54	130	35	95	46	115	2247,4	7675	1934,2	1,57	5,37	1,35	1429,0	8,52	61,84
cecomaf MBP	-10	14	55	131	32	90	55	131	1653,1	5646	1422,7	1,23	4,21	1,06	1340,7	8,15	52,92
EN12900 MBP	-10	14	45	113	20	68	45	113	1936,8	6614	1666,8	1,55	5,30	1,34	1247,5	7,78	58,34

## Performance tables

R404A, 220V/50Hz, CSIR, fan 3m/s, CCC, EAC, VDE

	pe		Cooling capacity			COP	EER	P1	I	m	
	[°C]	[°F]	[W]	[Btu/h]	[kcal/h]						
[°C / °F]	-20	-4	1217,5	4158	1047,8	1,24	4,25	1,07	978,3	6,74	33,03
cond. pressure	-15	5	1611,5	5504	1386,9	1,43	4,89	1,23	1124,8	7,29	44,02
pc= 45/113	-10	14	2055,5	7020	1769,0	1,65	5,63	1,42	1247,5	7,78	56,60
return gas temp.	-5	23	2558,7	8738	2202,0	1,90	6,48	1,63	1349,3	8,21	71,13
RGT= 32/90	0	32	3130,4	10691	2694,0	2,18	7,46	1,88	1432,7	8,58	88,00
liquid temp	5	41	3779,7	12908	3252,8	2,52	8,60	2,17	1500,4	8,88	107,67
Tliq= 45/113	15	59	5348,4	18266	4602,9	3,34	11,42	2,88	1600,0	9,31	157,71
[°C / °F]	-20	-4	931,6	3182	801,7	0,95	3,23	0,81	984,9	6,81	29,31
cond. pressure	-15	5	1277,4	4363	1099,4	1,09	3,71	0,93	1176,6	7,51	40,51
pc= 55/131	-10	14	1653,1	5646	1422,7	1,23	4,21	1,06	1340,7	8,15	52,92
return gas temp	-5	23	2067,9	7062	1779,7	1,40	4,77	1,20	1480,0	8,73	66,93
RGT= 32/90	0	32	2531,0	8644	2178,2	1,58	5,41	1,36	1597,2	9,25	83,00
liquid temp	5	41	3051,7	10422	2626,3	1,80	6,15	1,55	1695,0	9,71	101,63
Tliq= 55/131	15	59	4302,6	14694	3702,9	2,33	7,97	2,01	1843,1	10,44	149,21

## Model

Designation	<b>SC12/12DL</b>	<b>220-240V/50Hz</b>	<b>Conf. 2</b>	Sales code:	<b>104L4092</b>
-------------	------------------	----------------------	----------------	-------------	-----------------

## Configuration

Motorconfiguration	CSIR
Power supply (nominal)	220-240V/50Hz 1~
Refrigerant	R407C
Application	HBP
Voltage range	198-254V
Starting torque	HST
Approvals	CCC, EAC, VDE

## Ambient/ machine room temperatures minimum /maximum

Ambient temperature range:	10 - 38°C / 50 - 101°F
Machine room temperature range:	10 - 43°C / 50 - 110°F
Compressor cooling:	fan 3m/s

## Operation Limits

## Electrical accessories / wiring diagram

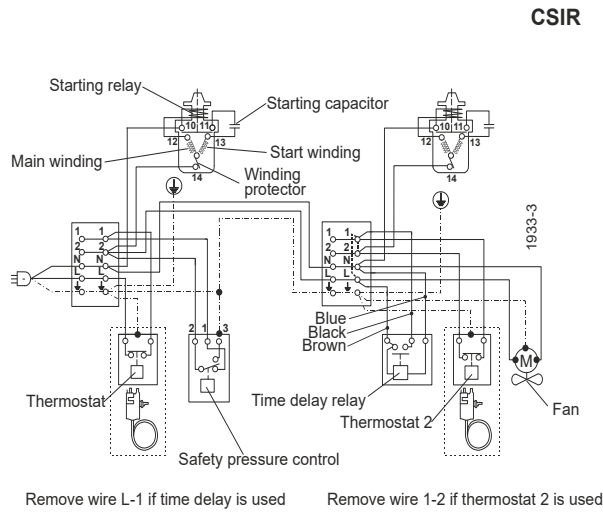
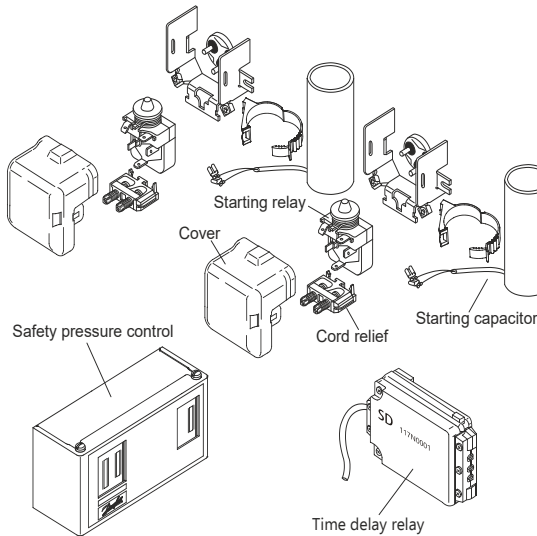

## Operation pressure range

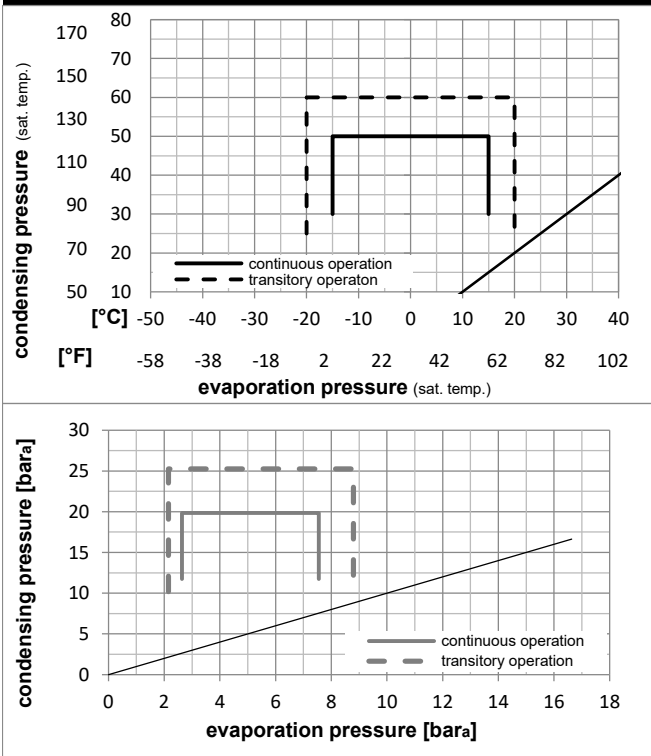

## Components

a2	relay	117U6019
c	start capacitor (80µF)	117U5017
d	cord relief	103N1004
b	plastic cover	103N2009
.	Check valve (to be used with time-delay relay)	020-1014
.	Service valve 12mm	118-7350
.	Solder connector (alternative) 12 mm	104B0584
.	Seal ring for service valve and solder conn.	118-3638

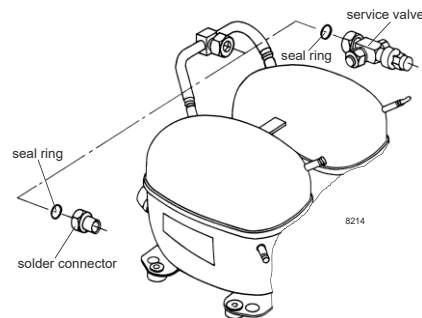

### Model

Designation	<b>SC12/12DL</b>	<b>220-240V/50Hz</b>	Conf. 2	Sales code:	<b>104L4092</b>
-------------	------------------	----------------------	---------	-------------	-----------------

### Optimization + standard conditions

R407C, 220V/50Hz, CSIR, fan 3m/s, CCC, EAC, VDE

		Evaporating pressure (saturation temperature)				Condensing pressure (saturation temperature)						Power consumption			
		Return gas temp.		Liquid temp.		Cooling capacity		COP	EER		P1	Current consumption		Ref. mass flow	
		pe	pc	RGT	Tliq	[W]	[Btu/h]	[kcal/h]	[W/W]	[Btu/Wh]	[kcal/Wh]	[W]	[A]	[kg/h]	
[°C]	7,2	54	35	46	3385,0	11561	2913,2	2,38	8,13	2,05	1421,3	8,15	72,34	<b>ASHRAE HBP</b>	
[°F]	45	130	95	115											
[°C]	5	55	32	55	2748,5	9387	2365,4	1,98	6,78	1,71	1385,1	8,01	65,53	<b>cecomaf HBP</b>	
[°F]	41	131	90	131											
[°C]	5	50	20	50	2895,0	9887	2491,4	2,16	7,37	1,86	1341,4	7,81	70,16	<b>EN12900 HBP</b>	
[°F]	41	122	68	122											
[°C]	-7	54	35	46	1774,3	6060	1527,0	1,58	5,38	1,36	1125,4	7,02	37,05	<b>ASHRAE MBP</b>	
[°F]	20	130	95	115											
[°C]	-10	55	32	55	1328,5	4537	1143,3	1,28	4,37	1,10	1039,3	6,70	30,84	<b>cecomaf MBP</b>	
[°F]	14	131	90	131											
[°C]	-10	45	20	45	1604,4	5479	1380,8	1,57	5,35	1,35	1024,6	6,62	35,71	<b>EN12900 MBP</b>	
[°F]	14	113	68	113											

### Performance tables

R407C, 220V/50Hz, CSIR, fan 3m/s, CCC, EAC, VDE

	pe		Cooling capacity			COP	EER		P1	I	m
	[°C]	[°F]	[W]	[Btu/h]	[kcal/h]	[W/W]	[Btu/Wh]	[kcal/Wh]	[W]	[A]	[kg/h]
[°C / °F]	-15	5	1263,5	4315	1087,4	1,39	4,73	1,19	912,2	6,23	26,25
cond. pressure	-10	14	1661,5	5674	1429,9	1,62	5,54	1,40	1024,6	6,62	34,71
pc= 45/113	-5	23	2130,5	7276	1833,5	1,89	6,47	1,63	1124,4	6,98	44,80
return gas temp.	0	32	2680,3	9154	2306,7	2,21	7,55	1,90	1211,8	7,30	56,81
RGT= 32/90	5	41	3320,7	11341	2857,8	2,58	8,81	2,22	1286,9	7,58	71,05
liquid temp	10	50	4061,6	13871	3495,5	3,01	10,28	2,59	1349,7	7,82	87,87
Tliq= 45/113	15	59	4913,0	16779	4228,2	3,51	11,98	3,02	1400,4	8,03	107,69
[°C / °F]	-15	5	988,6	3376	850,8	1,10	3,76	0,95	897,9	6,19	22,81
cond. pressure	-10	14	1328,5	4537	1143,3	1,28	4,37	1,10	1039,3	6,70	30,84
pc= 55/131	-5	23	1728,5	5903	1487,6	1,48	5,06	1,27	1167,6	7,18	40,43
return gas temp	0	32	2198,6	7508	1892,1	1,71	5,85	1,47	1282,8	7,61	51,87
RGT= 32/90	5	41	2748,5	9387	2365,4	1,98	6,78	1,71	1385,1	8,01	65,53
liquid temp	10	50	3388,3	11572	2916,0	2,30	7,85	1,98	1474,5	8,37	81,78
Tliq= 55/131	15	59	4127,7	14097	3552,4	2,66	9,09	2,29	1551,2	8,69	101,10

# SC Twin Compressors

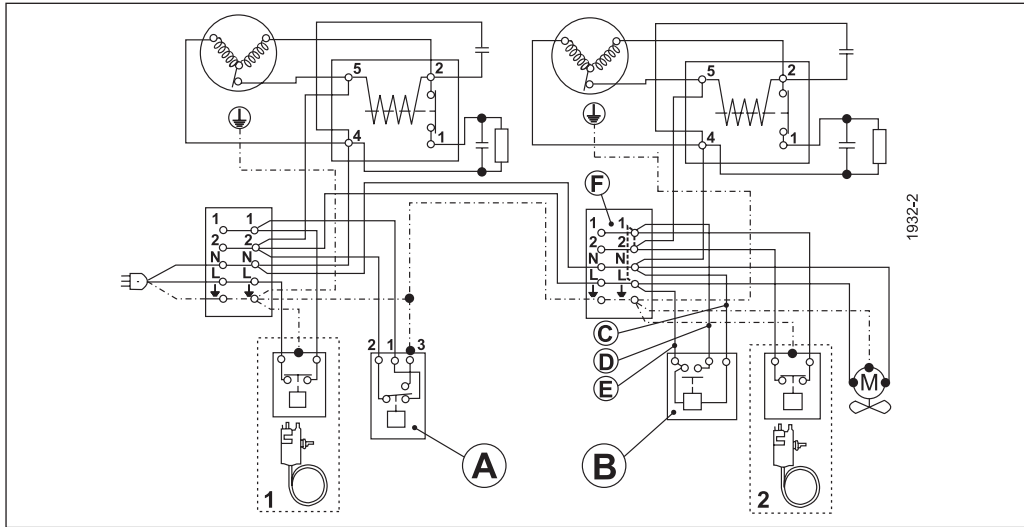
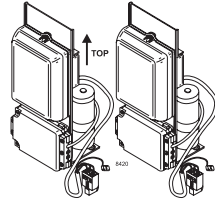
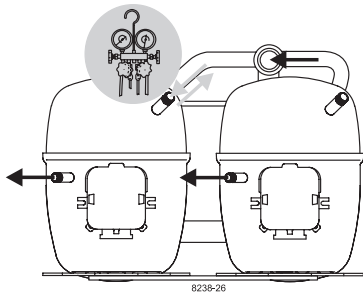

	A	B	C	D	E	F	
ENGLISH	Safety pressure control	Time delay relay	Blue	Black	Brown	Remove wire L-1 if time delay is used	Remove wire 1-2 if thermostat 2 is used
中文	安全压力控制	延时继电器	蓝	黑	棕	若延时继电器使用，线L-1不使用	若温控器2使用，线1-2不使用
Русский	Предохранительное реле давления	Реле задержки времени	Синий	Чёрный	Коричневый	Отсоедините провод L-1, если используется реле задержки времени	Отсоедините провод 1-2, если используется термостат 2
DEUTSCH	Sicherheitsdruckschalter	Zeitrelais (verzögernd)	Blau	Schwarz	Braun	Bei Benutzung der Anlaßverzögerung Brücke L-1 entfernen	Bei Benutzung von Thermostat 2 Brücke 1-2 entfernen
FRANÇAIS	Pressostat	Relais de temporisation	Bleu	Noir	Marron	Supprimer la connection L-1 si le relais de temporisation est utilisé	Supprimer la connection 1-2 si thermostat 2 est utilisé
ESPAÑOL	Presostato de seguridad	Relé de retardo	Azul	Negro	Marrón	Quitar cable L-1, si se utiliza un relé de retardo	Quitar cable 1-2, si se utiliza el termostato 2
ITALIANO	Pressostato	Relè di ritardo avviam.	Blu	Nero	Marrone	Eliminare il cavo L-1 se è utilizzato il ritardatore	Eliminare il cavo 1-2 se è utilizzato il termostato 2
NEDERLANDS	Pressostaat	Tijdvertragingrelais	Blauw	Zwart	Bruin	Verwijder draad L-1 indien tijdvertraging wordt toegepast	Verwijder draad 1-2 indien thermostaat wordt toegepast
DANSK	Sikkerhedspressostat	Tidsforsinkelsesrelæ	Blå	Sort	Brun	Ved tidsforsinkelse fjernes ledning L-1	Ved termostat 2 fjernes ledning 1-2
SVENSKA	Säkerhetspressostat	Tidsfördröjningsrelä	Blå	Svart	Brun	Vid anslutning av tidfördröjningsrelä avlägsnas bygling L-1	Vid anslutning av termostat 2 avlägsnas bygling 1-2



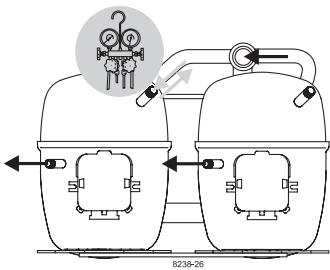

# SC Twin Compressors

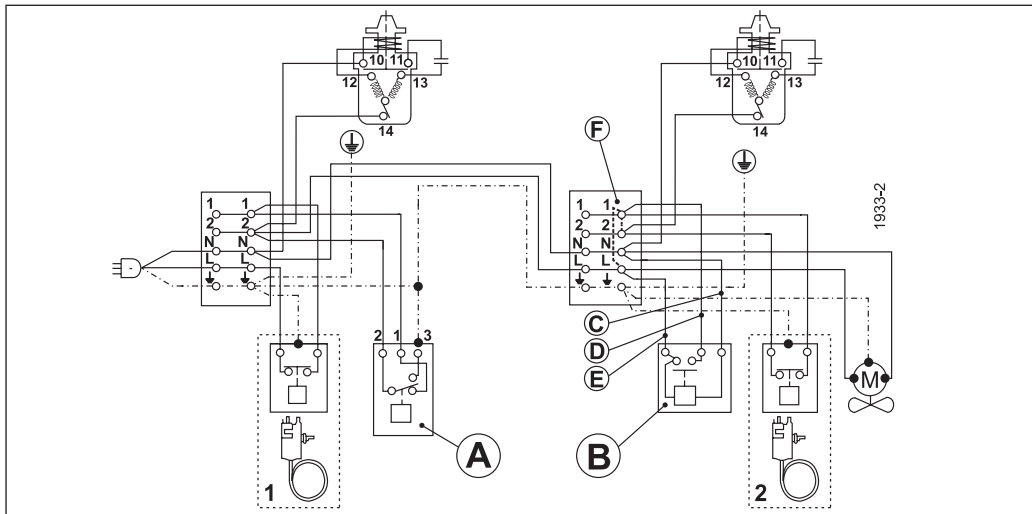
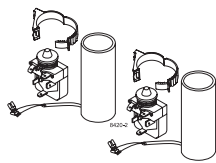

	A	B	C	D	E	F	
ENGLISH	Safety pressure control	Time delay relay	Blue	Black	Brown	Remove wire L-1 if time delay is used	Remove wire 1-2 if thermostat 2 is used
中文	安全压力控制	延时继电器	蓝	黑	棕	若延时继电器使用, 线L-1不使用	若温控器2使用, 线1-2不使用
Русский	Предохранительное реле давления	Реле задержки времени	Синий	Чёрный	Коричневый	Отсоедините провод L-1, если используется реле задержки времени	Отсоедините провод 1-2, если используется термостат 2
DEUTSCH	Sicherheitsdruckschalter	Zeitrelais (verzögernd)	Blau	Schwarz	Braun	Bei Benutzung der Anlaufverzögerung Brücke L-1 entfernen	Bei Benutzung von Thermostat 2 Brücke 1-2 entfernen
FRANÇAIS	Pressostat	Relais de temporisation	Bleu	Noir	Marron	Supprimer la connection L-1 si le relais de temporisation est utilisé	Supprimer la connection 1-2 si thermostat 2 est utilisé
ESPAÑOL	Presostato de seguridad	Relé de retardo	Azul	Negro	Marrón	Quitar cable L-1, si se utiliza un relé de retardo	Quitar cable 1-2, si se utiliza el termostato 2
ITALIANO	Pressostato	Relè di ritardo avvia.	Blu	Nero	Marrone	Eliminare il cavo L-1 se è utilizzato il ritardatore	Eliminare il cavo 1-2 se è utilizzato il termostato 2
NEDERLANDS	Pressostaat	Tijdvertraging-relais	Blauw	Zwart	Bruin	Verwijder draad L-1 indien tijdvertraging wordt toegepast	Verwijder draad 1-2 indien thermostaat wordt toegepast
DANSK	Sikkerhedspressostat	Tidsforsinkel-sesrelæ	Blå	Sort	Brun	Ved tidsforsinkelse fjernes ledning L-1	Ved termostat 2 fjernes ledning 1-2
SVENSKA	Säkerhetspressostat	Tidsfördröjningsrelä	Blå	Svart	Brun	Vid anslutning av tidsfördröjningsrelä avlägsnas bygling L-1	Vid anslutning av termostat 2 avlägsnas bygling 1-2

Secop accepts no responsibility for possible errors in catalogs, brochures, and other printed material. Secop reserves the right to alter its products without notice. This also applies to products already on order provided that such alterations can be made without subsequent changes being necessary to specifications already agreed. All trademarks in this material are the property of the respective companies. Secop and the Secop logotype are trademarks of Secop GmbH. All rights reserved. [www.secop.com](http://www.secop.com)