

Single Pack SC10/10DL 220-240V 50Hz CSIR

Single pack code number: **195B3365**

Position	Title	Code	Amount
1	Compressor SC10/10DL	104L4091	1
2	Starting relay	117U6005	2
3	Starting capacitor (80 μ F 220V, 6.3mm)	117U5017	2
4	Cord relief	103N1004	2
5	Cover	103N2009	2
6	Bolt joint for one compressor M6 \varnothing 16mm	118-1917	1

Secop GmbH • Lise-Meitner-Straße 29 • 24941 Flensburg, Germany • Tel: +49 461 4941 0 • www.secop.com

Secop accepts no responsibility for possible errors in catalogs, brochures, and other printed material. Secop reserves the right to alter its products without notice. This also applies to products already on order provided that such alterations can be made without subsequent changes being necessary to specifications already agreed. All trademarks in this material are the property of the respective companies. Secop and the Secop logotype are trademarks of Secop GmbH. All rights reserved.

Model

Designation	SC10/10DL	220-240V/50Hz 1~	Sales code:	104L4091
-------------	------------------	------------------	-------------	-----------------

Compressor design

Oil type	Polyolester	Refrigerant(s)	R404A, R507, R407C
Oil viscosity	32cST	Displacement	20,58cm ³ / 1,26cu.in
Oil quantity	1233cm ³ / 41,7fl.oz	Compressors on pallet	18
Refr. charge - tech. limit	2200g / 77,6oz		
Free gas volume comp.	2820cm ³ / 95,4fl.oz		
Weight	26,8kg / 59,1lbs		
Motor protection	1# internal		
Winding resistance main	5,13Ω (at 25°C)		
Winding resistance aux	13,51Ω (at 25°C)		
Max. winding temp.	125°C / 257°F		
Max. discharge temp.	135°C / 275°F		



General - Configurations with SC10/10DL

	Conf. 1	Conf. 2
Motorconfiguration	CSIR	CSIR
Power supply (nominal)	220-240V/50Hz	220-240V/50Hz
Number of phases	1	1
Voltage range	198-254V	198-254V
Approvals	CCC, EAC, VDE	CCC, EAC, VDE
Starting torque	HST	HST
Note	- / -	

Applications with SC10/10DL

	Conf. 1	Conf. 2
Refrigerant	R404A	R407C
Application	HBP	HBP
System cooling	fan 3m/s	fan 3m/s
Hot gas defrost	OK	OK
Long interval pull down	OK	OK

Electrical data - Configurations with SC10/10DL

	Conf. 1	Conf. 2
Starting device type	relay	relay
Run capacitor	- / -	- / -
Start capacitor	80μF	80μF
LRA (locked rotor amps / 4s)	2x 23,4A	2x 23,4A
RLA (rated load amps / 1s)	2x 4,3A	2x 4,3A
Cut in current	2x 23,4A	2x 23,4A

Model

Designation

SC10/10DL

220-240V/50Hz 1~

Sales code:

104L4091

Compressor dimensions

Housing	A Height	249mm / 9,8in
	B Height	244mm / 9,61in
	B1	183mm / 7,2in
	B2	100mm / 3,94in

Connectors		Suction	Discharge	Process
		C	E	D
Diameter	[mm]	øi 15,21-15,37	øi 6,11-6,29	øi 6,11-6,29
(i:inside, o:outside)	[in]	øi 0,6-0,61	øi 0,24-0,25	øi 0,24-0,25
Material		steel	copper	copper
Horizontal angle	±2°	0°	37°	37°
Vertical angle	±2°	0°	0°	0°
Position l/h/w	[mm]	0/0/0	0/0/0	0/0/0
	[in]	0/0/0	0/0/0	0/0/0
Straight tube l.	[mm]	10	12	12
	[in]	0,4	0,5	0,5

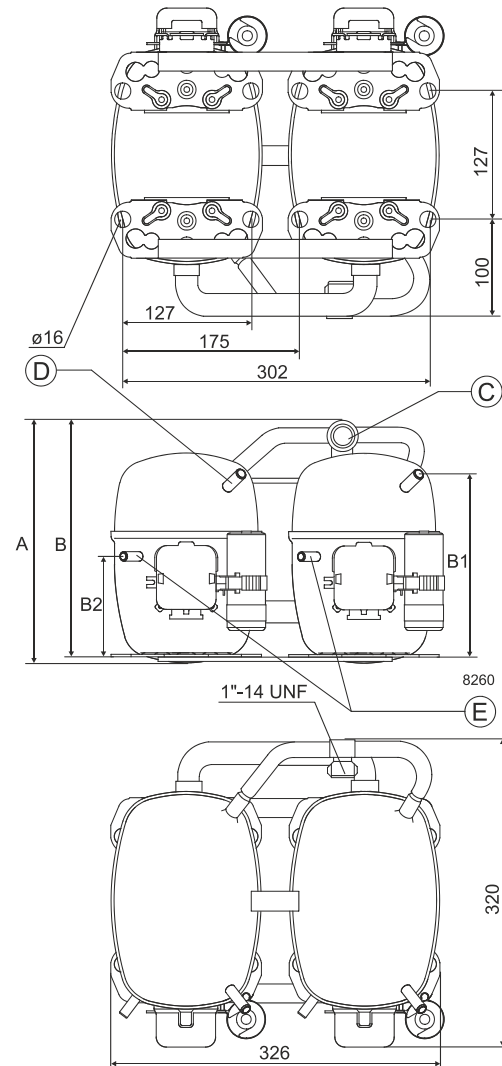

Compressor fixation

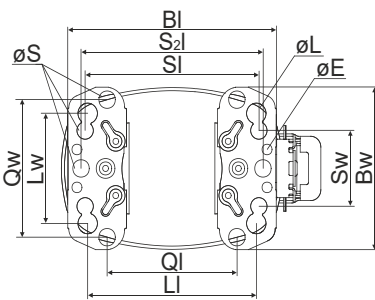

Baseplate	[mm]	[inch]
BI	204	8.03
Bw	150	5.9
øE	ø 9.7	ø 0.38
Large holes		
LI	165	6.5
Lw	101.6	4
øL	ø 19	ø 0.75
Small holes		
SI	170	6.7
Sw	70	2.76
øS	ø 16	ø 0.63
QI	127	5
Qw	127	5

Mounting accessories

	one comp.	multi pack
Bolt joint M6 ø16mm	118-1917	118-1918
Bolt joint ø1/4" ø16mm	118-1946	
Bolt joint ø1/4" ø19mm	118-1949	
Snap-on ø7,3 ø16mm	118-1947	118-1919

Bolt joint

Snap-on

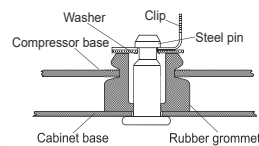
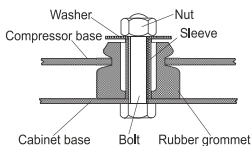

Application notes

Provision for PE Grounding is located at the PE Stamp on the compressor

Twin should be used with a time-delay relay

Model

Designation	SC10/10DL	220-240V/50Hz	Conf. 1	Sales code:	104L4091
-------------	------------------	----------------------	----------------	-------------	-----------------

Configuration

Motorconfiguration	CSIR
Power supply (nominal)	220-240V/50Hz 1~
Refrigerant	R404A
Application	HBP
Voltage range	198-254V
Starting torque	HST
Approvals	CCC, EAC, VDE

Ambient/ machine room temperatures minimum /maximum

Ambient temperature range:	10 - 38°C / 50 - 101°F
Machine room temperature range:	10 - 43°C / 50 - 110°F
Compressor cooling:	fan 3m/s

Operation Limits

Electrical accessories / wiring diagram

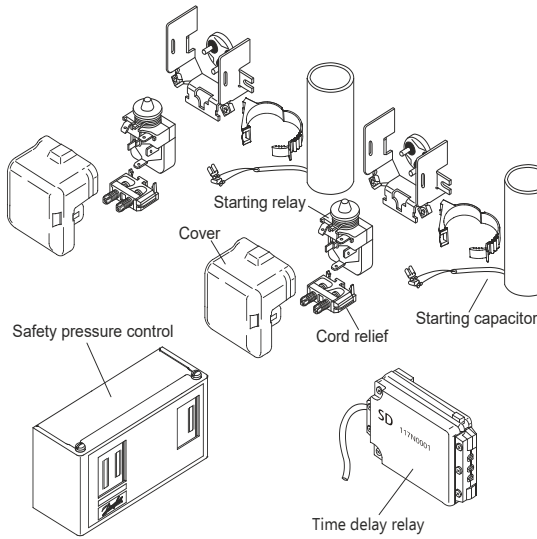

Operation pressure range

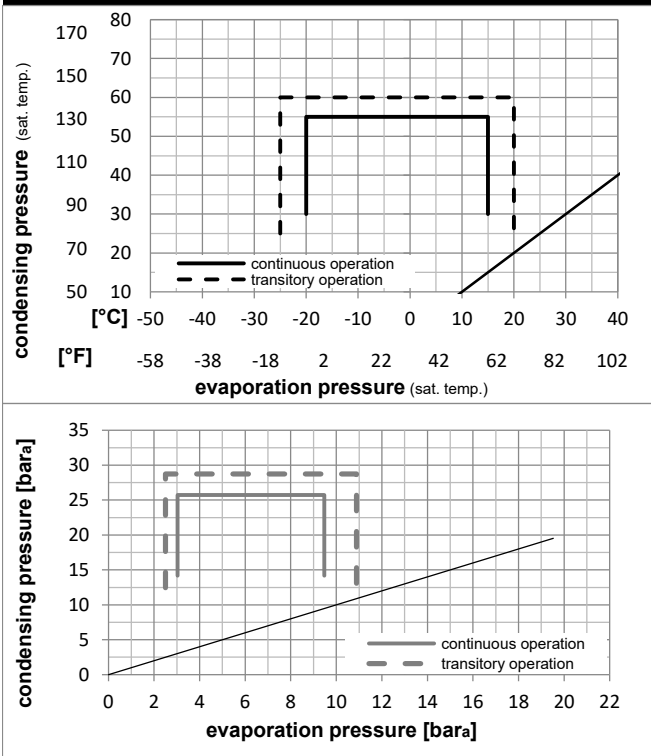

Components

a2	relay	117U6005
c	start capacitor (80μF)	117U5017
d	cord relief	103N1004
b	plastic cover	103N2009
.	Check valve (to be used with time-delay relay)	020-1014
.	Service valve 12mm	118-7350
.	Solder connector (alternative) 12 mm	104B0584
.	Seal ring for service valve and solder conn.	118-3638

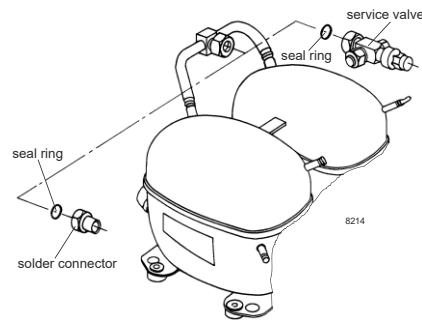

Model

Designation **SC10/10DL** **220-240V/50Hz** Conf. 1 Sales code: **104L4091**

Optimization + standard conditions

R404A, 220V/50Hz, CSIR, fan 3m/s, CCC, EAC, VDE

		Evaporating pressure (saturation temperature)				Condensing pressure (saturation temperature)						Power consumption					
		Return gas temp.		Liquid temp.		Cooling capacity		COP	EER		P1	I	Ref. mass flow				
		pe	pc	RGT	Tliq	[W]	[Btu/h]	[kcal/h]	[W/W]	[Btu/Wh]	[kcal/Wh]	[W]	[A]	[kg/h]			
[°C]	[°F]																
7,2	45	54	130	35	95	46	115	2956,0	10095	2544,0	2,15	7,35	1,85	1373,5	7,59	84,05	ASHRAE HBP
5	41	55	131	32	90	55	131	2311,6	7894	1989,4	1,71	5,85	1,47	1349,9	7,49	76,98	cecomaf HBP
5	41	50	122	20	68	50	122	2415,7	8250	2079,0	1,92	6,56	1,65	1257,3	7,15	82,38	EN12900 HBP
-7	20	54	130	35	95	46	115	1676,1	5724	1442,4	1,51	5,16	1,30	1109,7	6,54	46,12	ASHRAE MBP
-10	14	55	131	32	90	55	131	1227,0	4190	1056,0	1,18	4,05	1,02	1035,6	6,25	39,28	cecomaf MBP
-10	14	45	113	20	68	45	113	1460,7	4989	1257,1	1,53	5,21	1,31	957,0	5,95	44,00	EN12900 MBP

Performance tables

R404A, 220V/50Hz, CSIR, fan 3m/s, CCC, EAC, VDE

	pe		Cooling capacity			COP	EER		P1	I	m
	[°C]	[°F]	[W]	[Btu/h]	[kcal/h]	[W/W]	[Btu/Wh]	[kcal/Wh]	[W]	[A]	[kg/h]
[°C / °F]	-20	-4	942,5	3219	811,1	1,26	4,31	1,09	746,8	5,11	25,57
cond. pressure	-15	5	1221,5	4172	1051,2	1,42	4,86	1,23	857,8	5,55	33,37
pc= 45/113	-10	14	1550,3	5294	1334,2	1,62	5,53	1,39	957,0	5,95	42,69
return gas temp.	-5	23	1935,3	6609	1665,5	1,85	6,33	1,60	1044,0	6,30	53,80
RGT= 32/90	0	32	2383,2	8139	2051,0	2,13	7,28	1,83	1118,3	6,60	67,00
liquid temp	5	41	2900,4	9905	2496,1	2,46	8,40	2,12	1179,7	6,85	82,63
Tliq= 45/113	15	59	4169,1	14238	3588,0	3,30	11,28	2,84	1262,3	7,21	122,94
[°C / °F]	-20	-4	699,5	2389	602,0	0,92	3,15	0,79	757,5	5,19	22,01
cond. pressure	-15	5	948,1	3238	815,9	1,05	3,58	0,90	903,2	5,74	30,07
pc= 55/131	-10	14	1227,0	4190	1056,0	1,18	4,05	1,02	1035,6	6,25	39,28
return gas temp	-5	23	1542,9	5269	1327,8	1,34	4,56	1,15	1154,4	6,71	49,94
RGT= 32/90	0	32	1902,2	6496	1637,1	1,51	5,16	1,30	1259,3	7,12	62,38
liquid temp	5	41	2311,6	7894	1989,4	1,71	5,85	1,47	1349,9	7,49	76,98
Tliq= 55/131	15	59	3306,4	11292	2845,6	2,22	7,60	1,91	1486,8	8,08	114,66

Model

Designation	SC10/10DL	220-240V/50Hz	Conf. 2	Sales code:	104L4091
-------------	------------------	----------------------	----------------	-------------	-----------------

Configuration

Motorconfiguration	CSIR
Power supply (nominal)	220-240V/50Hz 1~
Refrigerant	R407C
Application	HBP
Voltage range	198-254V
Starting torque	HST
Approvals	CCC, EAC, VDE

Ambient/ machine room temperatures minimum /maximum

Ambient temperature range:	10 - 38°C / 50 - 101°F
Machine room temperature range:	10 - 43°C / 50 - 110°F
Compressor cooling:	fan 3m/s

Operation Limits

Electrical accessories / wiring diagram

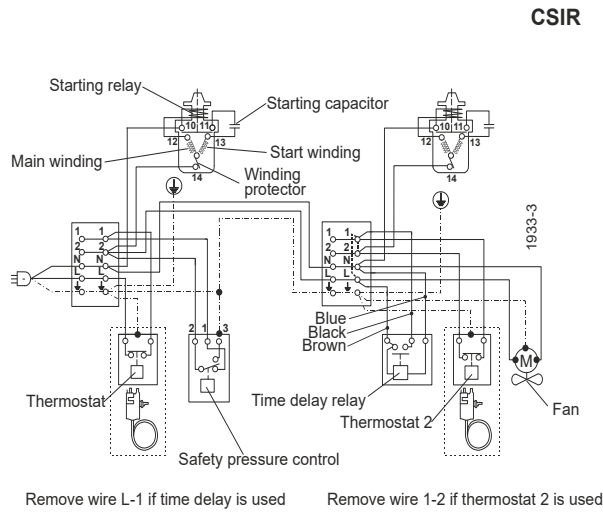
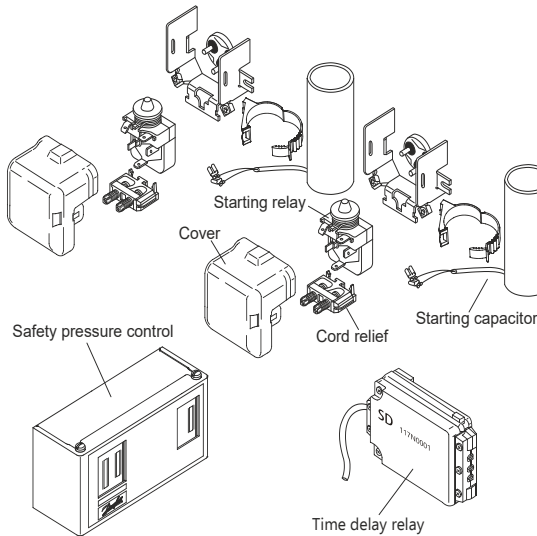

Operation pressure range

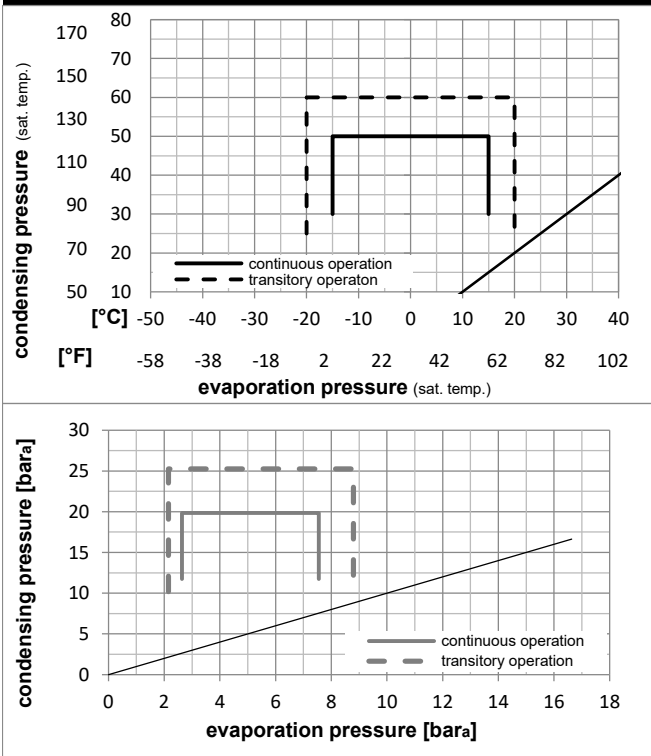

Components

a2	relay	117U6005
c	start capacitor (80μF)	117U5017
d	cord relief	103N1004
b	plastic cover	103N2009
.	Check valve (to be used with time-delay relay)	020-1014
.	Service valve 12mm	118-7350
.	Solder connector (alternative) 12 mm	104B0584
.	Seal ring for service valve and solder conn.	118-3638

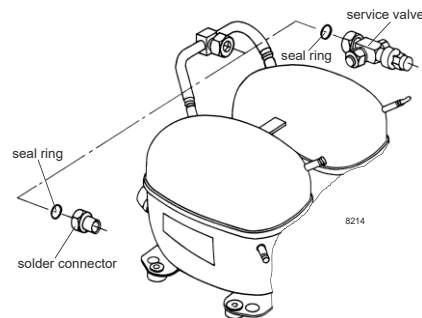

Model

Designation	SC10/10DL	220-240V/50Hz	Conf. 2	Sales code:	104L4091
-------------	------------------	----------------------	---------	-------------	-----------------

Optimization + standard conditions

R407C, 220V/50Hz, CSIR, fan 3m/s, CCC, EAC, VDE

		Evaporating pressure (saturation temperature)				Condensing pressure (saturation temperature)						Power consumption			
		Return gas temp.		Liquid temp.		Cooling capacity		COP	EER		P1	Current consumption		Ref. mass flow	
		pe	pc	RGT	Tliq	[W]	[Btu/h]	[kcal/h]	[W/W]	[Btu/Wh]	[kcal/Wh]	[W]	[A]	[kg/h]	
[°C]	7,2	54	35	46	2616,2	8935	2251,5	2,32	7,91	1,99	1129,4	6,58	55,91	ASHRAE HBP	
[°F]	45	130	95	115											
[°C]	5	55	32	55	2127,3	7265	1830,8	1,94	6,62	1,67	1098,1	6,45	50,72	cecomaf HBP	
[°F]	41	131	90	131											
[°C]	5	50	20	50	2243,1	7661	1930,5	2,12	7,24	1,82	1058,8	6,31	54,37	EN12900 HBP	
[°F]	41	122	68	122											
[°C]	-7	54	35	46	1373,2	4690	1181,8	1,57	5,36	1,35	875,5	5,61	28,67	ASHRAE MBP	
[°F]	20	130	95	115											
[°C]	-10	55	32	55	1022,6	3492	880,0	1,27	4,35	1,10	803,3	5,36	23,74	cecomaf MBP	
[°F]	14	131	90	131											
[°C]	-10	45	20	45	1228,7	4196	1057,5	1,56	5,32	1,34	788,3	5,32	27,35	EN12900 MBP	
[°F]	14	113	68	113											

Performance tables

R407C, 220V/50Hz, CSIR, fan 3m/s, CCC, EAC, VDE

	pe		Cooling capacity			COP	EER		P1	I	m
	[°C]	[°F]	[W]	[Btu/h]	[kcal/h]	[W/W]	[Btu/Wh]	[kcal/Wh]	[W]	[A]	[kg/h]
[°C / °F]	-15	5	960,9	3282	827,0	1,39	4,74	1,19	692,8	5,00	19,96
cond. pressure	-10	14	1272,4	4346	1095,1	1,61	5,51	1,39	788,3	5,32	26,58
pc= 45/113	-5	23	1641,9	5607	1413,0	1,88	6,41	1,62	874,2	5,62	34,53
return gas temp.	0	32	2077,0	7093	1787,5	2,18	7,46	1,88	951,0	5,90	44,03
RGT= 32/90	5	41	2585,7	8831	2225,3	2,54	8,66	2,18	1019,6	6,16	55,32
liquid temp	10	50	3175,7	10846	2733,1	2,94	10,04	2,53	1080,8	6,40	68,70
Tliq= 45/113	15	59	3854,9	13165	3317,5	3,40	11,60	2,92	1135,2	6,63	84,50
[°C / °F]	-15	5	745,3	2545	641,4	1,09	3,73	0,94	683,1	4,97	17,19
cond. pressure	-10	14	1022,6	3492	880,0	1,27	4,35	1,10	803,3	5,36	23,74
pc= 55/131	-5	23	1340,1	4577	1153,3	1,47	5,02	1,26	912,0	5,74	31,34
return gas temp	0	32	1705,8	5825	1468,0	1,69	5,77	1,45	1010,1	6,10	40,25
RGT= 32/90	5	41	2127,3	7265	1830,8	1,94	6,62	1,67	1098,1	6,45	50,72
liquid temp	10	50	2612,5	8922	2248,3	2,22	7,58	1,91	1177,1	6,77	63,06
Tliq= 55/131	15	59	3169,2	10823	2727,4	2,54	8,68	2,19	1247,5	7,08	77,63

SC Twin Compressors

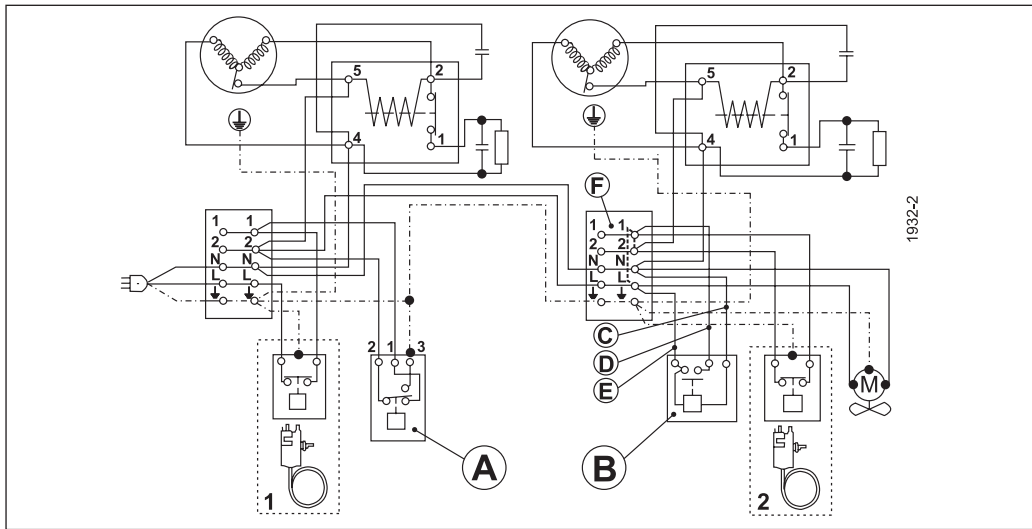
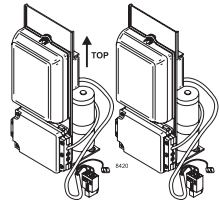
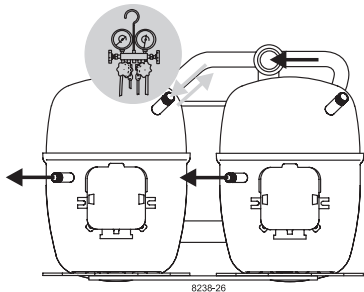

	A	B	C	D	E	F	
ENGLISH	Safety pressure control	Time delay relay	Blue	Black	Brown	Remove wire L-1 if time delay is used	Remove wire 1-2 if thermostat 2 is used
中文	安全压力控制	延时继电器	蓝	黑	棕	若延时继电器使用，线L-1不使用	若温控器2使用，线1-2不使用
Русский	Предохранительное реле давления	Реле задержки времени	Синий	Чёрный	Коричневый	Отсоедините провод L-1, если используется реле задержки времени	Отсоедините провод 1-2, если используется термостат 2
DEUTSCH	Sicherheitsdruckschalter	Zeitrelais (verzögernd)	Blau	Schwarz	Braun	Bei Benutzung der Anlaßverzögerung Brücke L-1 entfernen	Bei Benutzung von Thermostat 2 Brücke 1-2 entfernen
FRANÇAIS	Pressostat	Relais de temporisation	Bleu	Noir	Marron	Supprimer la connection L-1 si le relais de temporisation est utilisé	Supprimer la connection 1-2 si thermostat 2 est utilisé
ESPAÑOL	Presostato de seguridad	Relé de retardo	Azul	Negro	Marrón	Quitar cable L-1, si se utiliza un relé de retardo	Quitar cable 1-2, si se utiliza el termostato 2
ITALIANO	Pressostato	Relè di ritardo avviam.	Blu	Nero	Marrone	Eliminare il cavo L-1 se è utilizzato il ritardatore	Eliminare il cavo 1-2 se è utilizzato il termostato 2
NEDERLANDS	Pressostaat	Tijdvertraging-relais	Blauw	Zwart	Bruin	Verwijder draad L-1 indien tijdvertraging wordt toegepast	Verwijder draad 1-2 indien thermostaat wordt toegepast
DANSK	Sikkerhedspressostat	Tidsforsinkelsesrelæ	Blå	Sort	Brun	Ved tidsforsinkelse fjernes ledning L-1	Ved termostat 2 fjernes ledning 1-2
SVENSKA	Säkerhetspressostat	Tidsfördröjningsrelä	Blå	Svart	Brun	Vid anslutning av tidfördröjningsrelä avlägsnas bygling L-1	Vid anslutning av termostat 2 avlägsnas bygling 1-2

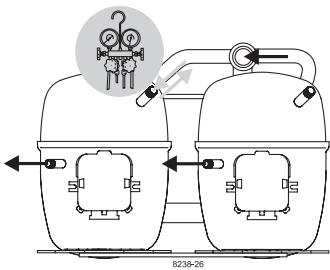

SC Twin Compressors

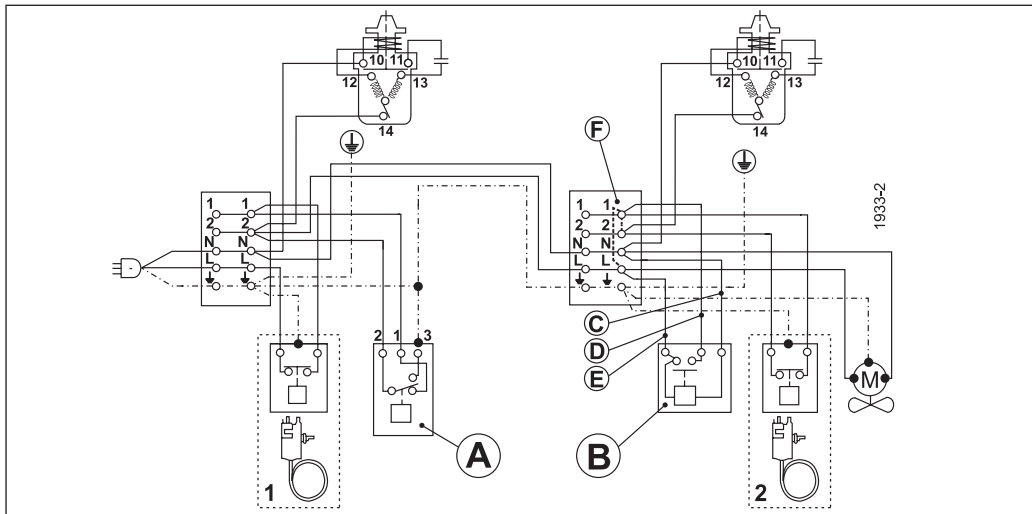
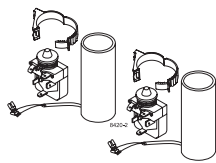

	A	B	C	D	E	F	
ENGLISH	Safety pressure control	Time delay relay	Blue	Black	Brown	Remove wire L-1 if time delay is used	Remove wire 1-2 if thermostat 2 is used
中文	安全压力控制	延时继电器	蓝	黑	棕	若延时继电器使用, 线L-1不使用	若温控器2使用, 线1-2不使用
Русский	Предохранительное реле давления	Реле задержки времени	Синий	Чёрный	Коричневый	Отсоедините провод L-1, если используется реле задержки времени	Отсоедините провод 1-2, если используется термостат 2
DEUTSCH	Sicherheitsdruckschalter	Zeitrelais (verzögernd)	Blau	Schwarz	Braun	Bei Benutzung der Anlaufverzögerung Brücke L-1 entfernen	Bei Benutzung von Thermostat 2 Brücke 1-2 entfernen
FRANÇAIS	Pressostat	Relais de temporisation	Bleu	Noir	Marron	Supprimer la connection L-1 si le relais de temporisation est utilisé	Supprimer la connection 1-2 si thermostat 2 est utilisé
ESPAÑOL	Presostato de seguridad	Relé de retardo	Azul	Negro	Marrón	Quitar cable L-1, si se utiliza un relé de retardo	Quitar cable 1-2, si se utiliza el termostato 2
ITALIANO	Pressostato	Relè di ritardo avvia.	Blu	Nero	Marrone	Eliminare il cavo L-1 se è utilizzato il ritardatore	Eliminare il cavo 1-2 se è utilizzato il termostato 2
NEDERLANDS	Pressostaat	Tijdvertraging-relais	Blauw	Zwart	Bruin	Verwijder draad L-1 indien tijdvertraging wordt toegepast	Verwijder draad 1-2 indien thermostaat wordt toegepast
DANSK	Sikkerhedspressostat	Tidsforsinkel-sesrelæ	Blå	Sort	Brun	Ved tidsforsinkelse fjernes ledning L-1	Ved termostat 2 fjernes ledning 1-2
SVENSKA	Säkerhetspressostat	Tidsfördröjningsrelä	Blå	Svart	Brun	Vid anslutning av tidsfördröjningsrelä avlägsnas bygling L-1	Vid anslutning av termostat 2 avlägsnas bygling 1-2

Secop accepts no responsibility for possible errors in catalogs, brochures, and other printed material. Secop reserves the right to alter its products without notice. This also applies to products already on order provided that such alterations can be made without subsequent changes being necessary to specifications already agreed. All trademarks in this material are the property of the respective companies. Secop and the Secop logotype are trademarks of Secop GmbH. All rights reserved. www.secop.com