

Single Pack BD50F 12/24V DC, 100-240V AC 50/60Hz PM

Single pack code number: **195B4188**

Position	Title	Code	Amount
1	Compressor BD50F	101Z0203	1
2	Electronic unit 12/24V DC, 100-240V AC 50/60Hz	101N0510	1
3	Bolt joint for one compressor M6 ø16mm	118-1917	1

BD50F Direct Current Compressor R134a, R1234yf, 12/24V DC & 100-240V AC 50/60Hz



General

Code number (without electronic units)	101Z0203
Electronic unit 12/24V DC - Standard	101N0242, 30 pcs: 101N0243
Electronic unit 12/24V DC - AEO	101N0340, 30 pcs: 101N0341
Electronic unit 12/24V DC & 100-240V AC 50/60Hz	101N0510, 28 pcs: 101N0511
Electronic unit 12/24V DC - Automotive	101N0680, 30 pcs: 101N0681
Compressors on pallet	150

Approvals

R134a	R134a/R1234yf
–	–
VDE	UL / CB
VDE	UL / CB
–	UL / CB



Application

Application	LBP/MBP/HBP
Evaporating temperature	°F -20 to 50
Voltage range DC	VDC 9.6 - 17 / 21.3 - 31.5
Voltage range AC	V/Hz 100 - 240 / 50 - 60
Max. condensing temperature continuous (short)	°F 140 (158)
Max. winding temperature continuous (short)	°F 257 (275)

Cooling requirements

Application	LBP	MBP	HBP
32°C	S	S	F ₁
38°C	S	S	F ₁
43°C	S	S	F ₁

Remarks on application: Fan cooling F₁ depending on application and speed.

Motor

Motor type	variable speed
Resistance, all 3 windings (25°C)	Ω 1.8

Design

Displacement	cu.in.	0.15
Oil quantity (type)	fl.oz.	5.1 (polyolester)
Maximum refrigerant charge	oz.	10.5
Free gas volume in compressor	fl.oz.	29.6
Weight - Compressor/Electronic unit	lbs.	9.5 / 0.42 (Standard)

Standard battery protection settings (refer to electronic unit *Instructions* for optional settings)

Voltage	12V	24V
Cut out	VDC 10.4	22.8
Cut in	VDC 11.7	24.2

Dimensions

Height	inch	A	5.39
		B	5.32
		B1	5.04
		B2	2.87
Suction connector	location/l.D. inch angle	C	0.252-0259 40°
	material comment		Cu-plated steel Al cap
Process connector	location/l.D. inch angle	D	0.252-0259 45°
	material comment		Cu-plated steel Al cap
Discharge connector	location/l.D. inch angle	E	0.202-0.205 21°
	material comment		Cu-plated steel Al cap

Remarks: **inch connectors**

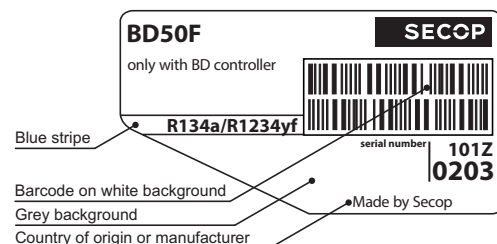

- S = Static cooling normally sufficient
- O = Oil cooling
- F₁ = Fan cooling 1.5 m/s
(compressor compartment temperature equal to ambient temperature)
- F₂ = Fan cooling 3.0 m/s necessary
- SG = Suction gas cooling normally sufficient
- = not applicable in this area

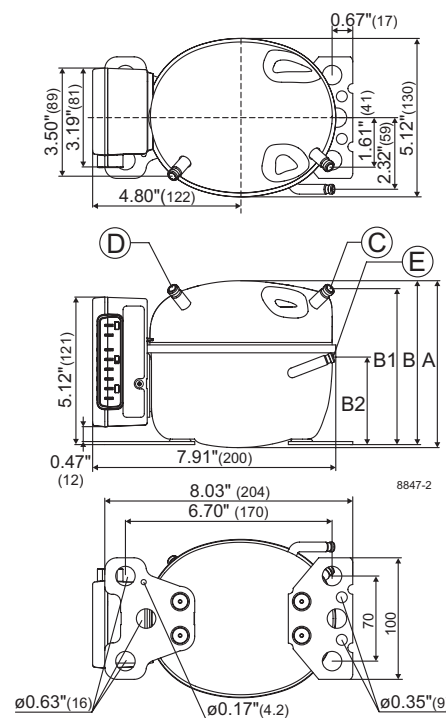

Performance Data with Refrigerant R134a

Capacity (ASHRAE LBP)		12V DC, static cooling										BTU/h
rpm \ °F	-20	-13	-10	0	10	14	20	30	40	41	45	50
2,000	96	127	142	202	274	307	360	459	572	584*	633*	698*
2,500	119	156	174	245	334	375	442	572	724	741*	810*	
3,000	143	189	211	297	403	452	531	682				
3,500	168	219	244	342	464	520*	613*	792*				

Capacity (EN 12900 Household/CECOMAF)		12V DC, static cooling										watt
rpm \ °F	-20	-13	-10	0	10	14	20	30	40	41	45	50
2,000	22.8	30.1	33.7	47.8	65.1	72.8	85.4	109	135	138*	150*	165*
2,500	28.2	37.0	41.3	58.1	79.1	88.7	105	135	171	175*	191*	
3,000	33.9	44.8	50.1	70.5	95.6	107	126	161				
3,500	40.0	52.0	57.9	81.0	110	123*	145*	187*				

Power consumption		12V DC, static cooling										watt
rpm \ °F	-20	-13	-10	0	10	14	20	30	40	41	45	50
2,000	26.4	31.4	33.5	40.5	47.4	50.3	54.8	63.0	72.2	73.2*	77.3*	82.8*
2,500	32.8	39.5	42.3	51.7	60.9	64.6	70.2	79.6	89.3	90.3*	94.4*	
3,000	39.9	48.0	51.4	62.5	73.2	77.5	84.0	95.0				
3,500	47.7	56.7	60.5	72.9	85.4	90.6*	98.7*	113*				

Current consumption (for 24V applications the following must be halved)												A
rpm \ °F	-20	-13	-10	0	10	14	20	30	40	41	45	50
2,000	2.19	2.58	2.76	3.37	4.01	4.29	4.70	5.43	6.20	6.28*	6.60*	7.01*
2,500	2.76	3.25	3.47	4.23	5.03	5.36	5.86	6.69	7.51	7.59*	7.91*	
3,000	3.38	3.99	4.26	5.16	6.08	6.46	7.03	7.99				
3,500	4.04	4.69	4.98	6.00	7.09	7.55*	8.27*	9.51*				

EER (ASHRAE LBP)		12V DC, static cooling										BTU/W
rpm \ °F	-20	-13	-10	0	10	14	20	30	40	41	45	50
2,000	3.64	4.04	4.24	4.98	5.78	6.10	6.57	7.29	7.92	7.98*	8.19*	8.43*
2,500	3.64	3.96	4.12	4.75	5.49	5.80	6.30	7.18	8.11	8.20*	8.58*	
3,000	3.58	3.93	4.10	4.76	5.51	5.82	6.32	7.18				
3,500	3.53	3.86	4.03	4.69	5.43	5.74*	6.21*	6.99*				

COP (EN 12900 Household/CECOMAF)		12V DC, static cooling										W/W
rpm \ °F	-20	-13	-10	0	10	14	20	30	40	41	45	50
2,000	0.86	0.95	1.00	1.17	1.36	1.43	1.54	1.71	1.86	1.87*	1.92*	1.97*
2,500	0.86	0.94	0.97	1.12	1.29	1.37	1.48	1.69	1.90	1.92*	2.01*	
3,000	0.85	0.93	0.97	1.12	1.30	1.37	1.49	1.68				
3,500	0.84	0.92	0.95	1.11	1.28	1.35*	1.46*	1.64*				

* fan cooling of electronic unit compulsory

Test conditions with electronic units		EN 12900/CECOMAF	ASHRAE LBP
Condensing temperature	101N0242 101N0680	131°F	130°F
Ambient temperature		90°F	90°F
Suction gas temperature		90°F	90°F
Liquid temperature		no subcooling	90°F

Accessories for BD50F		Code number
Bolt joint for one comp.	Ø: 5/8 in.	118-1917
Bolt joint in quantities	Ø: 5/8 in.	118-1918
Snap-on in quantities	Ø: 5/8 in.	118-1919
Remote kit (without cable)		105N9210
Secop Gateway		105N9518
DC usage:	Automobile fuse, DIN 7258 12V: 15A 24V: 7.5 A Main switch min. 20A	Not deliverable from Secop
AC usage:	Fuse, 100-240V Main switch min. 6A	

Compressor speed

Electronit unit	Resistor (R1) [Ω]	Motor speed
Code number	calculated values	[rpm]
101N0242 101N0510 101N0680	0	2,000
	277	2,500
	692	3,000
101N0340 with AEO	1523	3,500
	0	AEO
	173	2,000
	450	2,500
	865	3,000
	1696	3,500

In AEO (Adaptive Energy Optimizing) speed mode the BD compressor will always adapt its speed to the actual cooling demand.

Wire dimensions DC

Cross section	Size	Max. length* 12V operation		Max. length* 24V operation	
		[mm²]	[Gauge]	[m]	[ft.]
2.5	12	2.5	8	5	16
4	12	4	13	8	26
6	10	6	20	12	39
10	8	10	33	20	66

*Length between battery and electronic unit

Wire dimensions AC

Cross section min. 0.75 mm² or AWG 18

Operational errors

Error code or LED flashes	Error type
	Can be read out in the software TOOL4COOL®
6	Thermostat failure (If the NTC thermistor is short-circuit or has no connection).
5	Thermal cut-out of electronic unit (If the refrigeration system has been too heavily loaded, or if the ambient temperature is high, the electronic unit will run too hot).
4	Minimum motor speed error (If the refrigeration system is too heavily loaded, the motor cannot maintain minimum speed at approximately 1,850 rpm).
3	Motor start error (The rotor is blocked or the differential pressure in the refrigeration system is too high (>5 bar)).
2	Too many start attempts or fan over current (Too many compressor or fan starts in short time or fan current higher than 0.5A _{avg}).
1	Battery protection cut-out (The voltage is outside the cut-out setting).

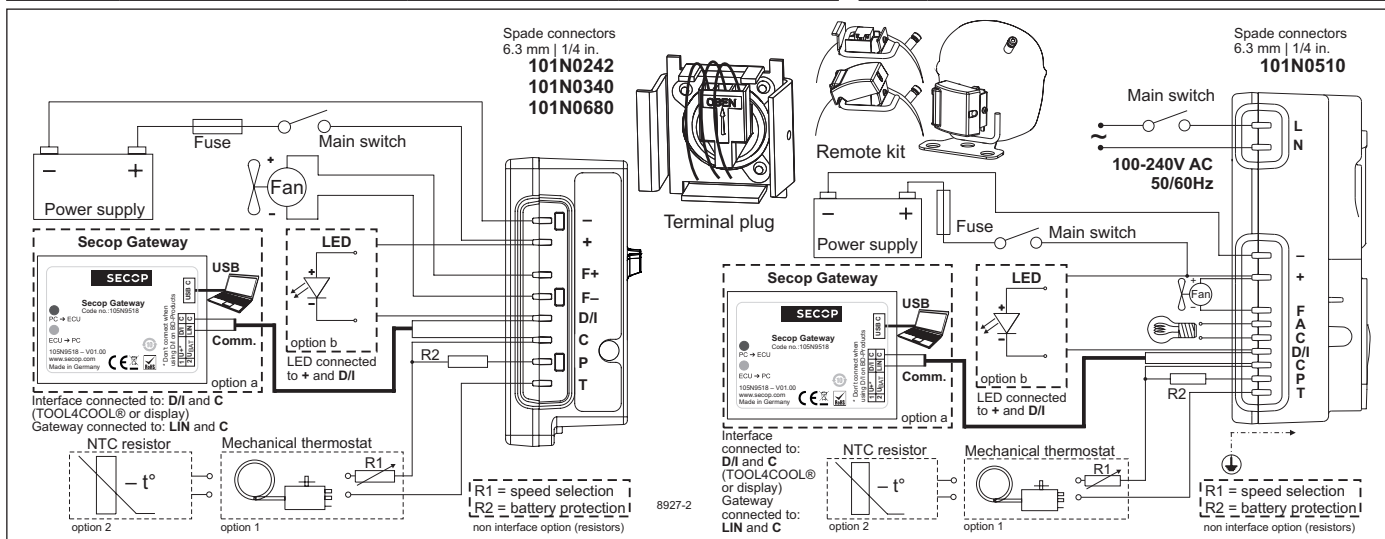

Performance Data with Refrigerant R1234yf

Capacity (ASHRAE LBP)		12V DC, static cooling										BTU/h
rpm \ °F	-20	-13	-10	0	10	14	20	30	40	41	45	50
2,000	110	142	158	216	286	317	368	462	568	579*	625*	686*
2,500	137	174	193	262	348	388	452	576	720	736*	801*	
3,000	164	211	233	318	421	468	544	688				
3,500	199	253	279	378	498	553*	641*	809*				

Capacity (EN 12900 Household/CECOMAF)		12V DC, static cooling										watt
rpm \ °F	-20	-13	-10	0	10	14	20	30	40	41	45	50
2,000	25.1	32.3	35.8	49.0	65.0	72.1	83.5	105	129	131*	142*	155*
2,500	31.0	39.5	43.7	59.5	79.0	87.9	102	130	163	166*	181*	
3,000	37.4	47.9	53.1	72.2	95.5	106	123	156				
3,500	45.2	57.5	63.6	86.0	113	125*	145*	183*				

Power consumption		12V DC, static cooling										watt
rpm \ °F	-20	-13	-10	0	10	14	20	30	40	41	45	50
2,000	26.4	31.4	33.5	40.5	47.4	50.3	54.8	63.0	72.2	73.2*	77.3*	82.8*
2,500	32.8	39.5	42.3	51.7	60.9	64.6	70.2	79.6	89.3	90.3*	94.4*	
3,000	39.9	48.0	51.4	62.5	73.2	77.5	84.0	95.0				
3,500	47.7	56.7	60.5	72.9	85.4	90.6*	98.7*	113*				

Current consumption (for 24V applications the following must be halved)												A
rpm \ °F	-20	-13	-10	0	10	14	20	30	40	41	45	50
2,000	2.19	2.58	2.76	3.37	4.01	4.29	4.70	5.43	6.20	6.28*	6.60*	7.01*
2,500	2.76	3.25	3.47	4.23	5.03	5.36	5.86	6.69	7.51	7.59*	7.91*	
3,000	3.38	3.99	4.26	5.16	6.08	6.46	7.03	7.99				
3,500	4.04	4.69	4.98	6.00	7.09	7.55*	8.27*	9.51*				

EER (ASHRAE LBP)		12V DC, static cooling										BTU/W
rpm \ °F	-20	-13	-10	0	10	14	20	30	40	41	45	50
2,000	3.94	4.33	4.52	5.17	5.85	6.12	6.54	7.22	7.88	7.95*	8.21*	8.52*
2,500	3.88	4.15	4.29	4.84	5.50	5.79	6.27	7.13	8.10	8.20*	8.62*	
3,000	3.86	4.15	4.30	4.87	5.54	5.83	6.29	7.13				
3,500	3.86	4.22	4.39	4.99	5.64	5.90*	6.31*	7.00*				

COP (EN 12900 Household/CECOMAF)		12V DC, static cooling										W/W
rpm \ °F	-20	-13	-10	0	10	14	20	30	40	41	45	50
2,000	0.89	0.98	1.02	1.16	1.32	1.38	1.47	1.62	1.77	1.78*	1.84*	1.90*
2,500	0.88	0.94	0.97	1.09	1.24	1.31	1.41	1.60	1.81	1.84*	1.93*	
3,000	0.88	0.94	0.98	1.10	1.25	1.31	1.41	1.60				
3,500	0.88	0.96	1.00	1.13	1.27	1.33*	1.42*	1.57*				

* fan cooling of electronic unit compulsory

Test conditions with electronic units		EN 12900/CECOMAF	ASHRAE LBP
Condensing temperature	101N0242 101N0510 101N0680	131°F	130°F
Ambient temperature		90°F	90°F
Suction gas temperature		90°F	90°F
Liquid temperature		no subcooling	90°F

Accessories for BD50F		Code number
Bolt joint for one comp.	Ø: 5/8 in.	118-1917
Bolt joint in quantities	Ø: 5/8 in.	118-1918
Snap-on in quantities	Ø: 5/8 in.	118-1919
Remote kit (without cable)		105N9210
Secop Gateway		105N9518
DC usage:	Automobile fuse, DIN 7258 12V: 15A 24V: 7.5 A Main switch min. 20A	Not deliverable from Secop
AC usage:	Fuse, 100-240V Main switch min. 6A	

Compressor speed

Electronit unit	Resistor (R1) [Ω]	Motor speed
Code number	calculated values	[rpm]
101N0242 101N0510 101N0680	0	2,000
	277	2,500
	692	3,000
101N0340 with AEO	1523	3,500
	0	AEO
	173	2,000
	450	2,500
	865	3,000
	1696	3,500

In AEO (Adaptive Energy Optimizing) speed mode the BD compressor will always adapt its speed to the actual cooling demand.

Wire dimensions DC

Cross section	Size	Max. length* 12V operation		Max. length* 24V operation	
		[mm²]	[Gauge]	[m]	[ft.]
2.5	12	2.5	8	5	16
4	12	4	13	8	26
6	10	6	20	12	39
10	8	10	33	20	66

*Length between battery and electronic unit

Wire dimensions AC

Cross section min. 0.75 mm² or AWG 18

Operational errors

Error code or LED flashes	Error type
	Can be read out in the software TOOL4COOL®
6	Thermostat failure (If the NTC thermistor is short-circuit or has no connection).
5	Thermal cut-out of electronic unit (If the refrigeration system has been too heavily loaded, or if the ambient temperature is high, the electronic unit will run too hot).
4	Minimum motor speed error (If the refrigeration system is too heavily loaded, the motor cannot maintain minimum speed at approximately 1,850 rpm).
3	Motor start error (The rotor is blocked or the differential pressure in the refrigeration system is too high (>5 bar)).
2	Too many start attempts or fan over current (Too many compressor or fan starts in short time or fan current higher than 0.5A _{avg}).
1	Battery protection cut-out (The voltage is outside the cut-out setting).

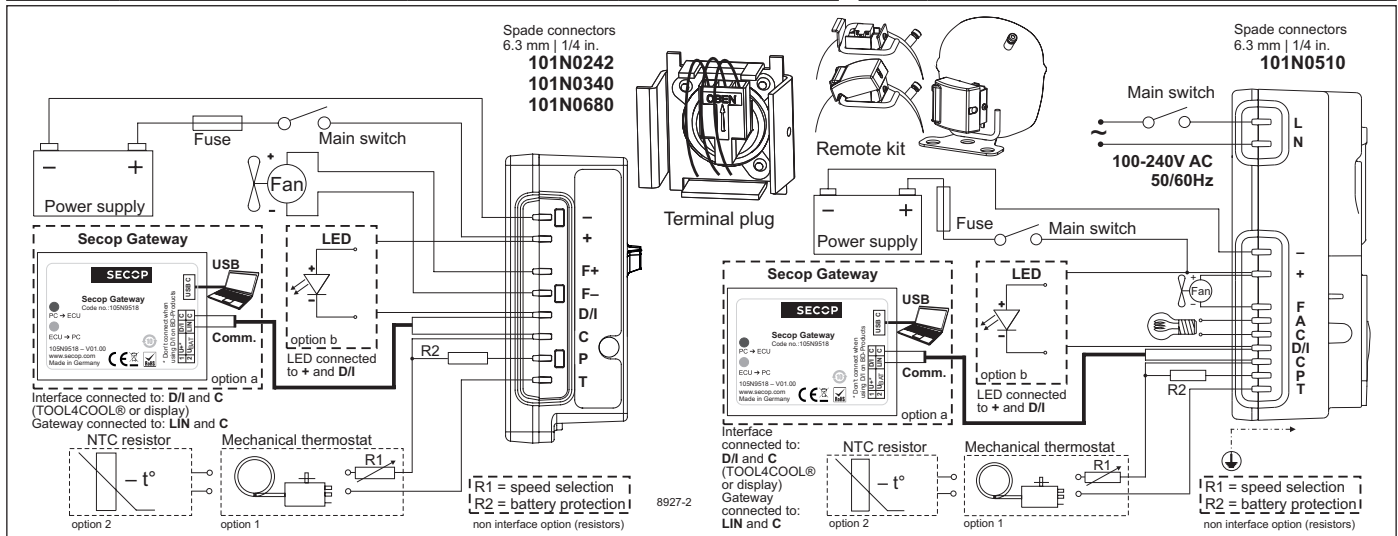

Secop accepts no responsibility for possible errors in catalogs, brochures, and other printed material. Secop reserves the right to alter its products without notice. This also applies to products already on order provided that such alterations can be made without consequential changes being necessary to specifications already agreed. All trademarks in this material are the property of the respective companies. Secop and the Secop logotype are trademarks of Secop GmbH. All rights reserved. www.secop.com



Instructions for Electronic Units
are available for download on
www.secop.com



BD Compressors



Service/Repair



8545

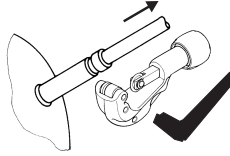

R290



R600a



R170



R1234yf

BD Nano

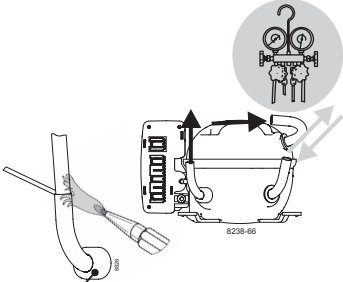

8238-66

**! max. 150°C/302°F !
at socket**

brazing solder: silver with flux

Do not heat up the bottom of the discharge
connector directly.
Do not braze longer than 10 seconds and
wait for 5 minutes for the next soldering
attempt (Product Bulletin DES.N.101.M1).

BD Micro

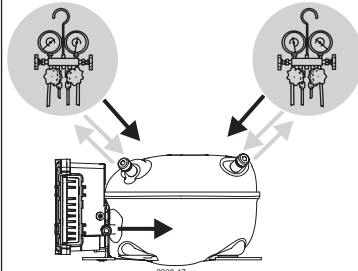

8238-47

BD P-Housing

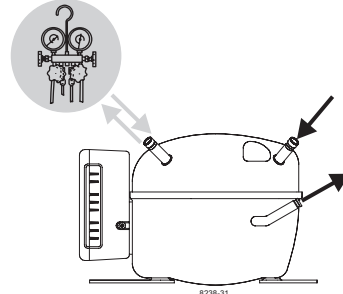

8238-31

BD T-Housing

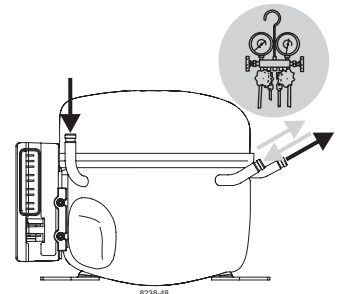

8238-48

Secop accepts no responsibility for possible errors in catalogs, brochures, and other printed material. Secop reserves the right to alter its products without notice. This also applies to products already on order provided that such alterations can be made without subsequent changes being necessary to specifications already agreed. All trademarks in this material are the property of the respective companies. Secop and the Secop logotype are trademarks of Secop GmbH. All rights reserved. www.secop.com