

Single Pack TL5G 220-240V 50/60Hz CSIR

Single pack code number: **195B4263**

Position	Title	Code	Amount
1	Compressor TL5G	102G4552	1
2	Starting relay	117U6000	1
3	Starting capacitor (60 μ F 220V, 6.3mm)	117U5014	1
4	Cord relief	103N1010	1
5	Cover	103N2010	1
6	Bolt joint for one compressor M6 \varnothing 16mm	118-1917	1

Secop GmbH • Lise-Meitner-Straße 29 • 24941 Flensburg, Germany • Tel: +49 461 4941 0 • www.secop.com

Secop accepts no responsibility for possible errors in catalogs, brochures, and other printed material. Secop reserves the right to alter its products without notice. This also applies to products already on order provided that such alterations can be made without subsequent changes being necessary to specifications already agreed. All trademarks in this material are the property of the respective companies. Secop and the Secop logotype are trademarks of Secop GmbH. All rights reserved.

TL5G Universal Compressor R134a 220-240V 50/60Hz

General

Code number	102G4552
Approvals	EN 60335-2-34
Compressors on pallet	125

Application

Application	LBP/HBP			
Frequency	Hz	50	60	
Evaporating temperature	°C	-30 to 15	-30 to -10	
Voltage range	V	187 - 254	198 - 254	
Max. condensing temperature continuous (short)	°C	60 (70)	60 (70)	
Max. winding temperature continuous (short)	°C	125 (135)	125 (135)	

Cooling requirements

Frequency	Hz	50			60		
Application		LBP	MBP	HBP	LBP	MBP	HBP
32°C		S	S	F ₂	S	S	-
38°C		S	S	F ₂	S	S	-
43°C		S	S	F ₂	S	S	-

Remarks on application: HBP at 198 - 254V 50Hz only.

Motor

Motor type	RSIR/CSIR		
LRA (rated after 4 sec. UL984), HST LST	A	5.7	5.4
Cut in Current, HST LST	A	5.7	9.7
Resistance, main start winding (25°C)	Ω	14.5	14.8

Design

Displacement	cm ³	5.08
Oil quantity (type)	cm ³	280 (polyolester)
Maximum refrigerant charge	g	400
Free gas volume in compressor	cm ³	1690
Weight without electrical equipment	kg	7.5

Dimensions

Height	mm	A	173
		B	169
		B1	-
		B2	-
Suction connector	location/I.D. mm angle	C	8.2 30°
	material comment		Copper Rubber plug
Process connector	location/I.D. mm angle	D	6.2 31.5°
	material comment		Copper Rubber plug
Discharge connector	location/I.D. mm angle	E	5.0 28°
	material comment		Copper Rubber plug
Oil cooler connector	location/I.D. mm angle	F	-
	material comment		-
Connector tolerance	I.D. mm		±0.09, on 5.0 +0.12/+0.20
Remarks:			

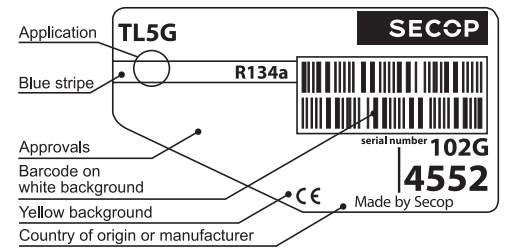

- S = Static cooling normally sufficient
- O = Oil cooling
- F₁ = Fan cooling 1.5 m/s (compressor compartment temperature equal to ambient temperature)
- F₂ = Fan cooling 3.0 m/s necessary
- SG = Suction gas cooling normally sufficient
- = not applicable in this area

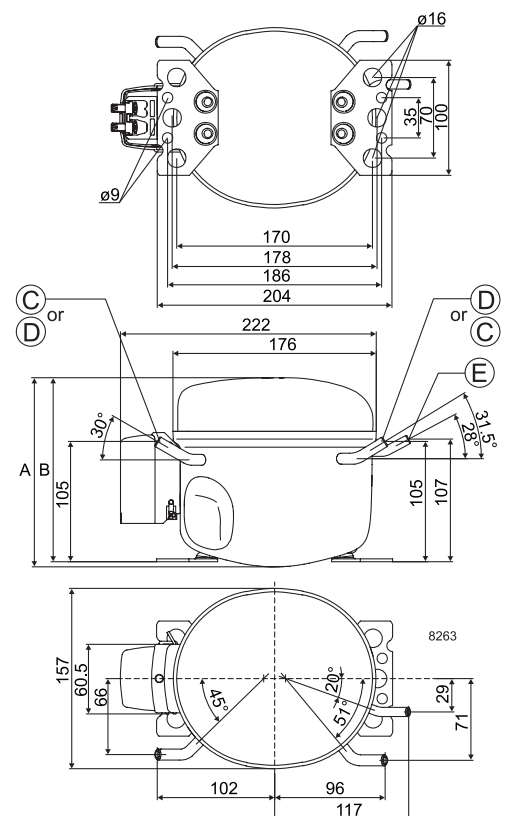

EN 12900 Household (CECOMAF) 220V, 50Hz, static cooling

Evap. temp. in °C	-45	-40	-35	-30	-25	-23.3	-20	-15	-10	-6.7	-5	0	5	7.2	10	15	20
Capacity in W				55.6	79.0	87.9	107	139	178	208	224	278	341	372	414	497	
Power cons. in W				84.8	100	105	116	132	149	161	167	186	205	213	224	245	
Current cons. in A				0.95	0.98	0.99	1.01	1.05	1.09	1.13	1.15	1.21	1.28	1.32	1.36	1.45	
COP in W/W				0.66	0.79	0.83	0.92	1.05	1.19	1.29	1.34	1.50	1.67	1.74	1.84	2.03	

EN 12900 Household (CECOMAF) 220V, 60Hz, static cooling

Evap. temp. in °C	-45	-40	-35	-30	-25	-23.3	-20	-15	-10	-6.7	-5	0	5	7.2	10	15	20
Capacity in W				64.7	91.5	102	123	162	207								
Power cons. in W				88.7	105.7	112.1	125	147	170								
Current cons. in A				0.83	0.88	0.90	0.94	1.01	1.08								
COP in W/W				0.73	0.87	0.91	0.99	1.10	1.22								

ASHRAE HBP 220V, 50Hz, static cooling

Evap. temp. in °C	-45	-40	-35	-30	-25	-23.3	-20	-15	-10	-6.7	-5	0	5	7.2	10	15	20
Capacity in W				68.6	97.5	108	132	172	220	257	277	345	423	461	514	619	
Power cons. in W				84.8	100	105	116	132	149	161	167	186	205	213	224	245	
Current cons. in A				0.95	0.98	0.99	1.01	1.05	1.09	1.13	1.15	1.21	1.28	1.32	1.36	1.45	
COP in W/W				0.81	0.97	1.03	1.14	1.30	1.47	1.59	1.66	1.86	2.07	2.16	2.29	2.53	

ASHRAE HBP 220V, 60Hz, static cooling

Evap. temp. in °C	-45	-40	-35	-30	-25	-23.3	-20	-15	-10	-6.7	-5	0	5	7.2	10	15	20
Capacity in W				79.8	113	125	152	200	256								
Power cons. in W				88.7	105.7	112.1	125	147	170								
Current cons. in A				0.83	0.88	0.90	0.94	1.01	1.08								
COP in W/W				0.90	1.07	1.12	1.22	1.36	1.51								



Accessories for	TL5G	Figure	Code number
PTC starting device	6.3 mm spade connectors	a1	103N0011
	4.8 mm spade connectors		103N0018
Starting relay	6.3 mm spade connectors	a2	117U6000
Start. capacitor 60 µF	6.3 mm spade connectors	c	117U5014
Cover		b	103N2010
Cord relief		d	103N1010
Protection screen for PTC		g	103N0476

Test conditions	EN 12900/CECOMAF	ASHRAE HBP
Condensing temperature	55°C	55°C
Ambient temperature	32°C	32°C
Suction gas temperature	32°C	32°C
Liquid temperature	55°C	32°C

Mounting accessories		Code number
Bolt joint for one comp.	Ø: 16 mm	118-1917
Bolt joint in quantities	Ø: 16 mm	118-1918
Snap-on in quantities	Ø: 16 mm	118-1919

Secop accepts no responsibility for possible errors in catalogs, brochures, and other printed material. Secop reserves the right to alter its products without notice. This also applies to products already on order provided that such alterations can be made without substantial changes being necessary to specifications already agreed. All trademarks in this material are the property of the respective companies. Secop and the Secop logotype are trademarks of Secop GmbH. All rights reserved. www.secop.com



TL Compressors





Service/Repair – R600a, R290



8545

Brazing on Suction Connectors (Direct Intake)

representative image



**! max. 150°C/302°F !
at socket**
brazing solder: phosphor (LP7) or silver

Refer to Product Bulletin:
**Brazing on Suction Connectors
(Compressors with Direct Suction Intake)**

Secop accepts no responsibility for possible errors in catalogs, brochures, and other printed material. Secop reserves the right to alter its products without notice. This also applies to products already on order provided that such alterations can be made without subsequential changes being necessary to specifications already agreed. All trademarks in this material are the property of the respective companies. Secop and the Secop logotype are trademarks of Secop GmbH. All rights reserved. www.secop.com