

## Single Pack NLE11MN 115-127V 60Hz CSIR

Single pack code number: **195B4306**

Position	Title	Code	Amount
1	Compressor NLE11MN	105H5982	1
2	Bolt joint for one compressor   M6   ø16mm	118-1917	1

**Secop GmbH** • Lise-Meitner-Straße 29 • 24941 Flensburg, Germany • Tel: +49 461 4941 0 • [www.secop.com](http://www.secop.com)

Secop accepts no responsibility for possible errors in catalogs, brochures, and other printed material. Secop reserves the right to alter its products without notice. This also applies to products already on order provided that such alterations can be made without subsequent changes being necessary to specifications already agreed. All trademarks in this material are the property of the respective companies. Secop and the Secop logotype are trademarks of Secop GmbH. All rights reserved.

## Model

Designation	<b>NLE11MN</b>	115-127V/60Hz 1~	Sales code:	<b>105H5982</b>
-------------	----------------	------------------	-------------	-----------------

## Compressor design

Oil type	Polyolester	Refrigerant(s)	<b>R290</b>
Oil viscosity	32cST	Displacement	11,15cm <sup>3</sup> / 0,68cu.in
Oil quantity	298cm <sup>3</sup> / 10,1fl.oz	Compressors on pallet	80
Refr. charge - tech. limit	400g / 14,1oz		
Free gas volume comp.	2360cm <sup>3</sup> / 79,8fl.oz		
Weight	12,14kg / 26,8lbs		
Motor protection	1# internal		
Winding resistance main	0,8Ω (at 25°C)		
Winding resistance aux	3,25Ω (at 25°C)		
Max. winding temp.	125°C / 257°F		
Max. discharge temp.	130°C / 266°F		



## General - Configurations with NLE11MN

	<b>Conf. 1</b>	<b>Conf. 2</b>
Motorconfiguration	CSIR	CSIR
Power supply (nominal)	115V/60Hz	115V/60Hz
Number of phases	1	1
Voltage range	95-127V	95-135V
Approvals	UL, CCC	UL, CCC
Starting torque	HST	HST
Note	Electrical equipment is included and pre-assembled to compressor.	

## Applications with NLE11MN

	<b>Conf. 1</b>	<b>Conf. 2</b>
Refrigerant	R290	R290
Application	MBP	MBP
System cooling	fan 3m/s	fan 3m/s
Hot gas defrost	OK	OK
Long interval pull down	OK	OK

## Electrical data - Configurations with NLE11MN

	<b>Conf. 1</b>	<b>Conf. 2</b>
Starting device type	relay	relay
Run capacitor	-/-	-/-
Start capacitor	240μF	240μF
LRA (locked rotor amps / 4s)	40,23A	40,23A
RLA (rated load amps / 1s)	8,37A	8,37A
Cut in current	40,23A	40,23A

## Model

Designation

**NLE11MN**

115-127V/60Hz 1~

Sales code:

**105H5982**

## Compressor dimensions

Housing	A Height	203mm / 7,99in
	B Height	197mm / 7,76in
	C Length shell	205mm / 8,07in
	D Length w. cover	254mm / 10in
	E Width	166mm / 6,54in

Connectors		Suction	Discharge	Process
		X	Y	Z
Diameter	[mm]	øi 8,11-8,29	øi 6,41-6,59	øi 6,41-6,59
	(i:inside, o:outside) [in]	øi 0,32-0,33	øi 0,25-0,26	øi 0,25-0,26
Material		copper	copper	copper
Horizontal angle	±2°	0°	0°	0°
Vertical angle	±2°	15°	21°	155°
Position l/h/w	[mm]	132/69/57	94/102/81	-109/94/72
	[in]	5,2/2,7/2,2	3,7/4/3,2	-4,3/3,7/2,8
Straight tube l.	[mm]	12	12	12
	[in]	0,5	0,5	0,5



## Compressor fixation



### Bolt joint

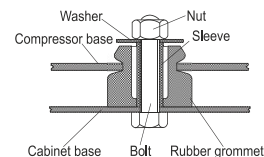

### Snap-on

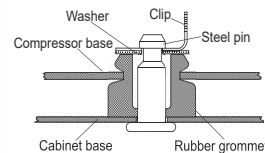

## Mounting accessories

	one comp.	multi pack
Bolt joint   M6   ø16mm	118-1917	118-1918
Bolt joint   ø1/4"   ø16mm	118-1946	
Bolt joint   ø1/4"   ø19mm	118-1949	
Snap-on   ø7,3   ø16mm	118-1947	118-1919

## Application notes

LRA value on compressor label and datasheet may differ due to different test conditions for UL approval.

Provision for PE Grounding is located at the PE Stamp on the compressor

### Model

Designation	<b>NLE11MN</b>	<b>115V/60Hz</b>	<b>Conf. 1</b>	Sales code:	<b>105H5982</b>
-------------	----------------	------------------	----------------	-------------	-----------------

### Configuration

Motorconfiguration	CSIR	
Power supply (nominal)	115V/60Hz 1~	
Refrigerant	R290	
Application	MBP	
Voltage range	95-127V	
Starting torque	HST	
Approvals	UL	SA3693
	CCC	

### Electrical accessories / wiring diagram

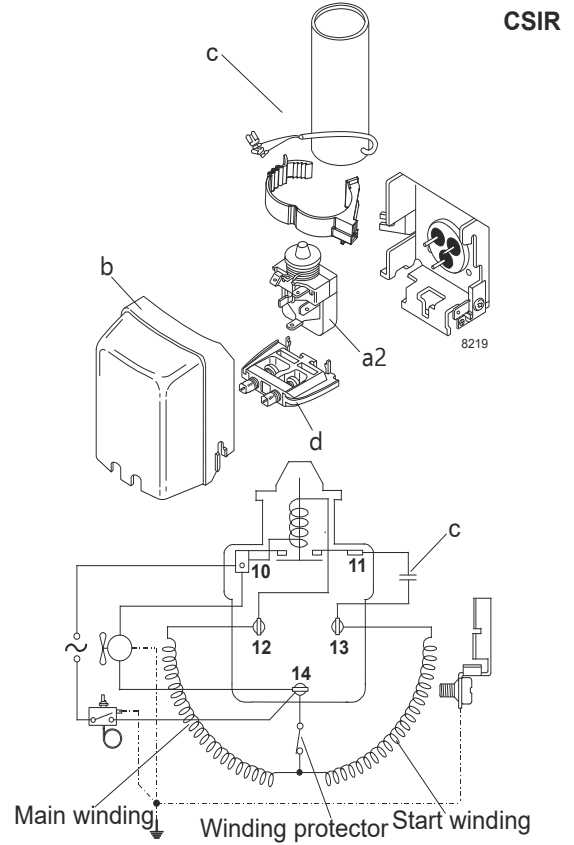

### Ambient/ machine room temperatures minimum /maximum

Ambient temperature range: 10 - 43°C / 50 - 110°F

Machine room temperature range: 10 - 48°C / 50 - 119°F

Compressor cooling: fan 3m/s

### Operation pressure range

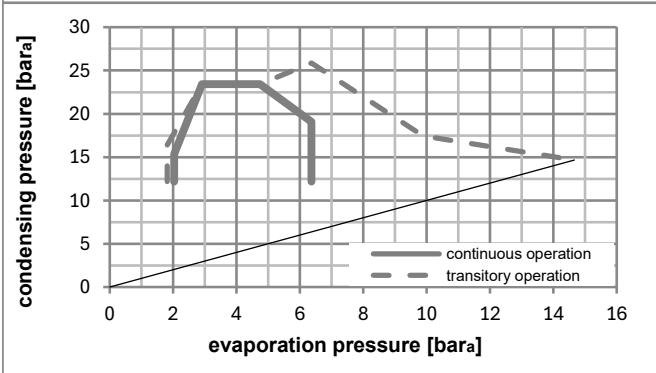
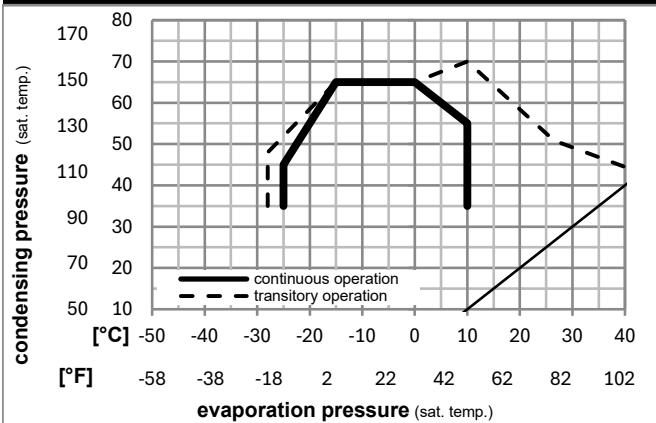

### Components (already pre-assembled)

a2	relay	117U7020
c	start capacitor (240µF, 15kOhm)	117U5034
b	plastic cover	103N2011
d	cord relief	103N1010

### Model

Designation	<b>NLE11MN</b>	<b>115V/60Hz</b>	<b>Conf. 1</b>	Sales code:	<b>105H5982</b>
-------------	----------------	------------------	----------------	-------------	-----------------

### Optimization + standard conditions

R290, 115V/60Hz, CSIR, fan 3m/s, UL, CCC

		Evaporating pressure (saturation temperature)				Condensing pressure (saturation temperature)			Return gas temp.		Liquid temp.		Cooling capacity			COP	EER	P1	Current consumption		Ref. mass flow	
		pe	pc	RGT	Tliq	[W]	[Btu/h]	[kcal/h]	[W/W]	[Btu/Wh]	[kcal/Wh]	[W]	I	m			[A]	[kg/h]				
[°C]	-7	54	35	46	1202,7	4107	1035,1	2,04	6,97	1,76	589,1	7,15	13,72	<b>ASHRAE MBP</b>								
[°F]	20	130	95	115																		
[°C]	-10	55	32	55	959,7	3278	825,9	1,71	5,83	1,47	561,8	6,96	12,14	<b>cecomaf MBP</b>								
[°F]	14	131	90	131																		
[°C]	-10	45	20	45	1058,4	3615	910,9	2,04	6,96	1,75	519,1	6,77	12,99	<b>EN12900 MBP</b>								
[°F]	14	113	68	113																		
[°C]	-7	49	18	49	1124,6	3841	967,8	2,00	6,83	1,72	562,1	7,01	14,60	<b>ARI540 MBP</b>								
[°F]	20	120	65	120																		
[°C]	-10	45	32	45	1101,8	3763	948,2	2,12	7,25	1,83	519,1	6,77	12,61	<b>opt</b>								
[°F]	14	113	90	113																		
[°C]	-25	45	32	45	594,0	2029	511,2	1,45	4,94	1,24	410,8	6,09	6,70	<b>opt</b>								
[°F]	-13	113	90	113																		

### Performance tables

R290, 115V/60Hz, CSIR, fan 3m/s, UL, CCC

	pe		Cooling capacity			COP	EER		P1	I	m
	[°C]	[°F]	[W]	[Btu/h]	[kcal/h]	[W/W]	[Btu/Wh]	[kcal/Wh]	[W]	[A]	[kg/h]
[°C / °F]	-25	-13	594,0	2029	511,2	1,45	4,94	1,24	410,8	6,09	6,70
cond. pressure	-23	-10	642,1	2193	552,6	1,52	5,18	1,31	422,9	6,17	7,25
pc= 45/113	-15	5	912,1	3115	784,9	1,89	6,44	1,62	483,7	6,54	10,38
return gas temp.	-9	15	1124,4	3840	967,7	2,15	7,34	1,85	523,0	6,79	12,87
RGT= 32/90	0	32	1558,6	5323	1341,3	2,67	9,11	2,29	584,5	7,21	18,08
liquid temp	4,4	40	1799,8	6147	1548,9	2,95	10,08	2,54	609,9	7,38	21,03
Tliq= 45/113	10	50	2139,1	7305	1840,9	3,36	11,46	2,89	637,3	7,58	25,28
[°C / °F]	-25	-13	498,1	1701	428,7	1,18	4,03	1,01	422,5	6,09	6,20
cond. pressure	-23	-10	542,7	1853	467,1	1,24	4,23	1,07	438,1	6,18	6,77
pc= 55/131	-15	5	789,0	2695	679,0	1,53	5,22	1,32	515,9	6,66	9,92
return gas temp	-9	15	979,9	3347	843,3	1,73	5,90	1,49	566,8	7,00	12,40
RGT= 32/90	0	32	1367,3	4670	1176,7	2,11	7,20	1,82	648,2	7,57	17,56
liquid temp	4,4	40	1582,1	5403	1361,5	2,32	7,91	1,99	683,0	7,83	20,49
Tliq= 55/131	10	50	1884,1	6435	1621,5	2,61	8,91	2,24	722,4	8,13	24,70

### Model

Designation	<b>NLE11MN</b>	<b>115V/60Hz</b>	<b>Conf. 2</b>	Sales code:	<b>105H5982</b>
-------------	----------------	------------------	----------------	-------------	-----------------

### Configuration

Motorconfiguration	CSIR	
Power supply (nominal)	115V/60Hz 1~	
Refrigerant	R290	
Application	MBP	
Voltage range	95-135V	
Starting torque	HST	
Approvals	UL	SA3693
	CCC	

### Electrical accessories / wiring diagram



### Ambient/ machine room temperatures minimum /maximum

Ambient temperature range:	10 - 43°C / 50 - 110°F
Machine room temperature range:	10 - 48°C / 50 - 119°F
Compressor cooling:	fan 3m/s

### Operation pressure range

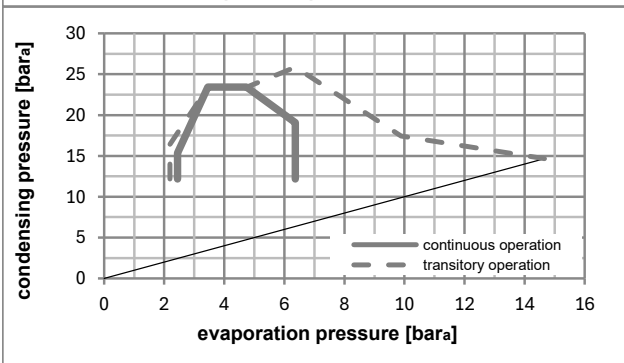
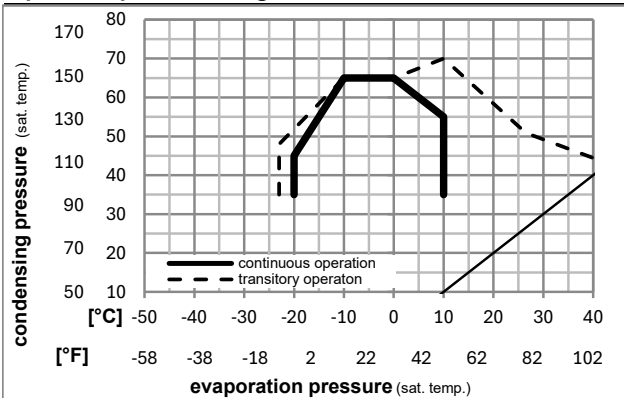

### Components (already pre-assembled)

a2	relay	117U7020
c	start capacitor (240µF, 15kOhm)	117U5034
b	plastic cover	103N2011
d	cord relief	103N1010

### Model

Designation	<b>NLE11MN</b>	<b>115V/60Hz</b>	<b>Conf. 2</b>	Sales code:	<b>105H5982</b>
-------------	----------------	------------------	----------------	-------------	-----------------

### Optimization + standard conditions

R290, 115V/60Hz, CSIR, fan 3m/s, UL, CCC

		Evaporating pressure (saturation temperature)				Cooling capacity			COP	EER	Power consumption				
		Condensing pressure (saturation temperature)									Current consumption		Ref. mass flow		
		Return gas temp.													
		Liquid temp.													
		Cooling capacity													
		pe	pc	RGT	Tliq	[W]	[Btu/h]	[kcal/h]	[W/W]	[Btu/Wh]	[kcal/Wh]	P1	I	m	
[°C]	[°F]	[°C]	[°F]	[°C]	[°F]							[W]	[A]	[kg/h]	
-7	20	54	130	35	95	1202,7	4107	1035,1	2,04	6,97	1,76	589,1	7,15	13,72	ASHRAE MBP
-10	14	55	131	32	90	959,7	3278	825,9	1,71	5,83	1,47	561,8	6,96	12,14	cecomaf MBP
-10	14	45	113	20	68	1058,4	3615	910,9	2,04	6,96	1,75	519,1	6,77	12,99	EN12900 MBP
-7	20	49	120	18	65	1124,6	3841	967,8	2,00	6,83	1,72	562,1	7,01	14,60	ARI540 MBP
-10	14	45	113	32	90	1101,8	3763	948,2	2,12	7,25	1,83	519,1	6,77	12,61	opt
-25	-13	45	113	32	90	594,0	2029	511,2	1,45	4,94	1,24	410,8	6,09	6,70	opt

### Performance tables

R290, 115V/60Hz, CSIR, fan 3m/s, UL, CCC

	pe		Cooling capacity			COP	EER	P1			I	m
	[°C]	[°F]	[W]	[Btu/h]	[kcal/h]	[W/W]	[Btu/Wh]	[kcal/Wh]	[W]	[A]	[kg/h]	
[°C / °F]	-20	-4	743,8	2540	640,1	1,66	5,68	1,43	447,3	6,31	8,42	
cond. pressure	-15	5	912,1	3115	784,9	1,89	6,44	1,62	483,7	6,54	10,38	
pc= 45/113	-9	15	1124,4	3840	967,7	2,15	7,34	1,85	523,0	6,79	12,87	
return gas temp.	-7	20	1241,9	4241	1068,8	2,29	7,83	1,97	541,9	6,92	14,27	
RGT= 32/90	0	32	1558,6	5323	1341,3	2,67	9,11	2,29	584,5	7,21	18,08	
liquid temp	4,4	40	1799,8	6147	1548,9	2,95	10,08	2,54	609,9	7,38	21,03	
Tliq= 45/113	10	50	2139,1	7305	1840,9	3,36	11,46	2,89	637,3	7,58	25,28	
[°C / °F]	-20	-4	636,2	2173	547,5	1,36	4,63	1,17	469,2	6,37	7,96	
cond. pressure	-15	5	789,0	2695	679,0	1,53	5,22	1,32	515,9	6,66	9,92	
pc= 55/131	-9	15	979,9	3347	843,3	1,73	5,90	1,49	566,8	7,00	12,40	
return gas temp	-7	20	1085,0	3705	933,8	1,83	6,26	1,58	591,6	7,17	13,79	
RGT= 32/90	0	32	1367,3	4670	1176,7	2,11	7,20	1,82	648,2	7,57	17,56	
liquid temp	4,4	40	1582,1	5403	1361,5	2,32	7,91	1,99	683,0	7,83	20,49	
Tliq= 55/131	10	50	1884,1	6435	1621,5	2,61	8,91	2,24	722,4	8,13	24,70	



# NL Compressors







## Service/Repair – R600a, R290

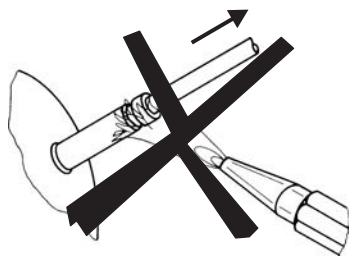

8545

## Brazing on Suction Connectors (Direct Intake)

representative image



**! max. 150°C/302°F !  
at socket**  
brazing solder: phosphor (LP7) or silver

Refer to Product Bulletin:  
**Brazing on Suction Connectors  
(Compressors with Direct Suction Intake)**

Secop accepts no responsibility for possible errors in catalogs, brochures, and other printed material. Secop reserves the right to alter its products without notice. This also applies to products already on order provided that such alterations can be made without subsequential changes being necessary to specifications already agreed. All trademarks in this material are the property of the respective companies. Secop and the Secop logotype are trademarks of Secop GmbH. All rights reserved. [www.secop.com](http://www.secop.com)