

Single Pack SC12MNX 220-240V 50Hz CSIR

Single pack code number: **195B4440**

Position	Title	Code	Amount
1	Compressor SC12MNX	104H8275	1
2	Starting relay	117U7019	1
3	Starting capacitor (80 μ F 220V, 6.3mm)	117U5017	1
4	Cord relief	103N1004	1
5	Cover	103N2008	1
6	Bolt joint for one compressor M6 \varnothing 16mm	118-1917	1

Secop GmbH • Lise-Meitner-Straße 29 • 24941 Flensburg, Germany • Tel: +49 461 4941 0 • www.secop.com

Secop accepts no responsibility for possible errors in catalogs, brochures, and other printed material. Secop reserves the right to alter its products without notice. This also applies to products already on order provided that such alterations can be made without subsequent changes being necessary to specifications already agreed. All trademarks in this material are the property of the respective companies. Secop and the Secop logotype are trademarks of Secop GmbH. All rights reserved.

Model

Designation	SC12MNX	220-240V/50Hz 1~	Sales code:	104H8275
-------------	----------------	------------------	-------------	-----------------

Compressor design

Oil type	Polyolester	Refrigerant(s)	R290
Oil viscosity	22cST	Displacement	12,87cm ³ / 0,79cu.in
Oil quantity	500cm ³ / 16,9fl.oz	Compressors on pallet	80
Refr. charge - tech. limit	150g / 5,3oz		
Free gas volume comp.	1510cm ³ / 51,1fl.oz		
Weight	13,5kg / 29,8lbs		
Motor protection	1# internal		
Winding resistance main	3,7Ω (at 25°C)		
Winding resistance aux	14Ω (at 25°C)		
Max. winding temp.	125°C / 257°F		
Max. discharge temp.	135°C / 275°F		



General - Configurations with SC12MNX

	Conf. 1
Motorconfiguration	CSIR
Power supply (nominal)	220-240V/50Hz
Number of phases	1
Voltage range	198-254V
Approvals	CCC, EAC, VDE
Starting torque	HST
Note	- / -

Applications with SC12MNX

	Conf. 1
Refrigerant	R290
Application	MBP
System cooling	fan 3m/s
Hot gas defrost	OK
Long interval pull down	OK

Electrical data - Configurations with SC12MNX

	Conf. 1
Starting device type	relay
Run capacitor	-/-
Start capacitor	80μF
LRA (locked rotor amps / 4s)	
RLA (rated load amps / 1s)	-/-A
Cut in current	

Model

Designation

SC12MNX

220-240V/50Hz 1~

Sales code:

104H8275

Compressor dimensions

Housing	A Height	219mm / 8,62in
	B Height	213mm / 8,39in
	C Length shell	218mm / 8,58in
	D Length w. cover	255mm / 10,04in
	E Width	151mm / 5,94in

Connectors	Suction X	Discharge Y	Process Z
Diameter [mm]	ø 8,11-8,29	ø 6,11-6,29	ø 6,11-6,29
(i:inside, o:outside) [in]	ø 0,32-0,33	ø 0,24-0,25	ø 0,24-0,25
Material	copper	copper	copper
Horizontal angle ±2°	37°	37°	143°
Vertical angle ±2°	30°	0°	150°
Position l/h/w [mm]	107/193/55	115/110/63	-107/193/55
[in]	4,2/7,6/2,2	4,5/4,3/2,5	-4,2/7,6/2,2
Straight tube l. [mm]	12	12	12
[in]	0,5	0,5	0,5



Compressor fixation



Bolt joint



Snap-on



Mounting accessories

Mounting accessories	one comp.	multi pack
Bolt joint M6 ø16mm	118-1917	118-1918
Bolt joint ø1/4" ø16mm	118-1946	
Bolt joint ø1/4" ø19mm	118-1949	
Snap-on ø7,3 ø16mm	118-1947	118-1919

Application notes

Provision for PE Grounding is located at the PE Stamp on the compressor

Model

Designation	SC12MNX	220-240V/50Hz	Conf. 1	Sales code:	104H8275
-------------	----------------	----------------------	----------------	-------------	-----------------

Configuration

Motorconfiguration	CSIR
Power supply (nominal)	220-240V/50Hz 1~
Refrigerant	R290
Application	MBP
Voltage range	198-254V
Starting torque	HST
Approvals	CCC EAC VDE

Electrical accessories / wiring diagram

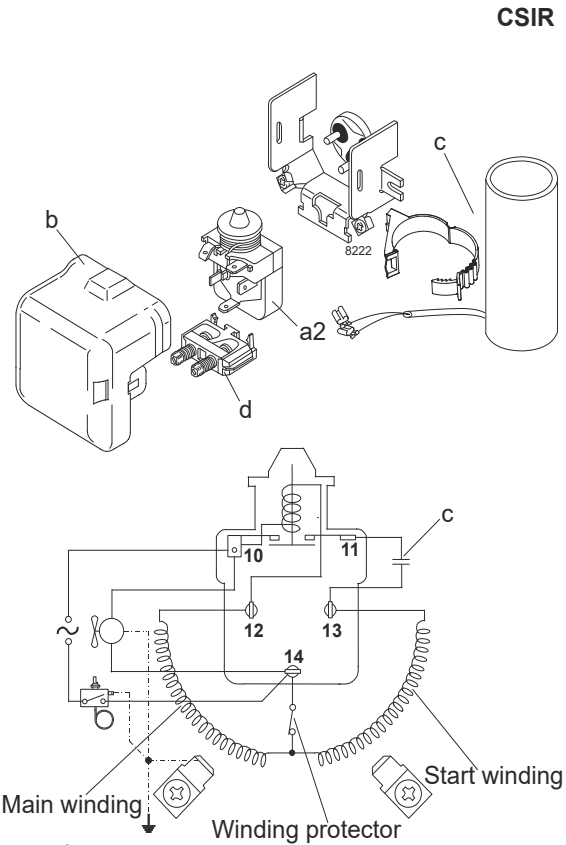

Ambient/ machine room temperatures minimum /maximum

Ambient temperature range:	10 - 43°C / 50 - 110°F
Machine room temperature range:	10 - 48°C / 50 - 119°F
Compressor cooling:	fan 3m/s

Operation Limits

Operation pressure range

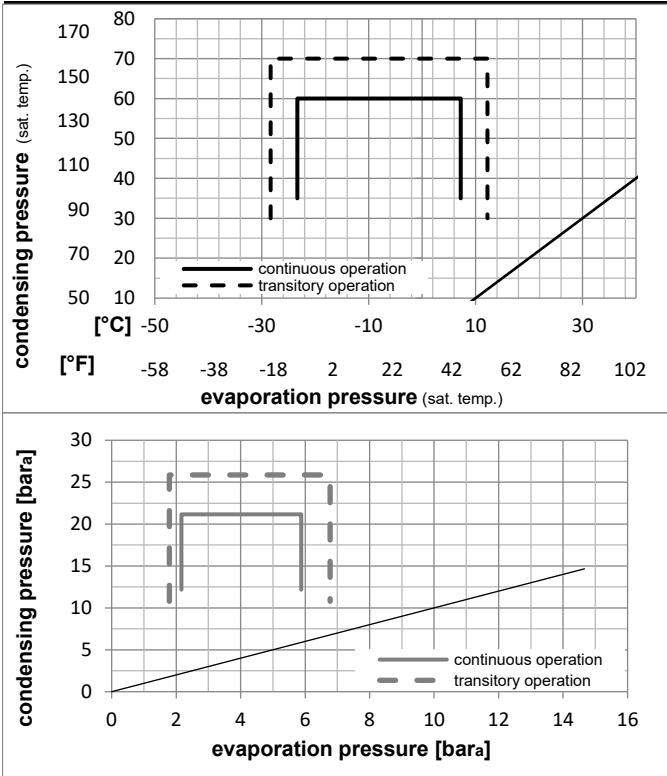

Components

a2	current relay	117U7019
c	start capacitor (80μF)	117U5017
d	cord relief	103N1004
b	plastic cover	103N2008

Model

Designation **SC12MNX** **220-240V/50Hz** Conf. 1 Sales code: **104H8275**

Optimization + standard conditions

R290, 220V/50Hz, CSIR, fan 3m/s, CCC, EAC, VDE

	Evaporating pressure (saturation temperature)				Condensing pressure (saturation temperature)			Return gas temp.	Liquid temp.	Cooling capacity	COP	EER	Power consumption			ASHRAE MBP
	pe	pc	RGT	Tliq	[W]	[Btu/h]	[kcal/h]						P1	I	Ref. mass flow	
[°C]	-7	54	35	46	996,6	3404	857,7	1,77	6,06	1,53	561,9	3,55	11,37			
[°F]	20	130	95	115												
	-10	55	32	55	774,9	2646	666,8	1,44	4,91	1,24	538,9	3,47	9,80	cecomaf MBP		
	-10	45	20	45	884,5	3021	761,2	1,78	6,09	1,53	496,2	3,34	10,86	EN12900 MBP		
	-7	49	18	49	946,8	3233	814,8	1,77	6,05	1,52	534,6	3,47	12,29	ARI540 MBP		
	-10	45	32	45	920,8	3145	792,5	1,86	6,34	1,60	496,2	3,34	10,53	opt		
	-25	45	32	45	447,2	1527	384,9	1,16	3,95	1,00	386,6	3,01	5,04	opt		

Performance tables

R290, 220V/50Hz, CSIR, fan 3m/s, CCC, EAC, VDE

	pe		Cooling capacity			COP	EER	P1	I	m	
	[°C]	[°F]	[W]	[Btu/h]	[kcal/h]	[W/W]	[Btu/Wh]	[kcal/Wh]	[W]	[A]	[kg/h]
[°C / °F]	-23	-10	491,5	1679	423,0	1,23	4,19	1,06	400,4	3,05	5,55
cond. pressure	-20	-4	583,8	1994	502,4	1,37	4,68	1,18	426,1	3,13	6,61
pc= 45/113	-15	5	740,8	2530	637,6	1,60	5,47	1,38	462,6	3,24	8,43
return gas temp.	-10	14	920,8	3145	792,5	1,86	6,34	1,60	496,2	3,34	10,53
RGT= 32/90	-5	23	1126,5	3847	969,5	2,14	7,30	1,84	527,3	3,44	12,97
liquid temp	0	32	1360,6	4647	1171,0	2,45	8,36	2,11	555,9	3,52	15,78
Tliq= 45/113	7,2	45	1753,0	5987	1508,6	2,95	10,09	2,54	593,3	3,64	20,59
[°C / °F]	-23	-10	380,7	1300	327,7	0,91	3,10	0,78	419,9	3,08	4,75
cond. pressure	-20	-4	465,9	1591	401,0	1,03	3,52	0,89	451,9	3,18	5,83
pc= 55/131	-15	5	610,1	2084	525,1	1,23	4,19	1,06	497,2	3,33	7,67
return gas temp	-10	14	774,9	2646	666,8	1,44	4,91	1,24	538,9	3,47	9,80
RGT= 32/90	-5	23	962,8	3288	828,6	1,67	5,70	1,44	577,1	3,61	12,27
liquid temp	0	32	1176,7	4019	1012,7	1,92	6,56	1,65	612,1	3,73	15,11
Tliq= 55/131	7,2	45	1535,6	5244	1321,6	2,34	7,98	2,01	657,3	3,90	20,01



SC Compressors





SC Compressors

Service/Repair – R290



8545



Secop accepts no responsibility for possible errors in catalogs, brochures, and other printed material. Secop reserves the right to alter its products without notice. This also applies to products already on order provided that such alterations can be made without subsequent changes being necessary to specifications already agreed. All trademarks in this material are the property of the respective companies. Secop and the Secop logotype are trademarks of Secop GmbH. All rights reserved. www.secop.com