

## Single Pack NF10FX 115-127V 60Hz CSIR

Single pack code number: **195B4470**

Position	Title	Code	Amount
1	Compressor NF10FX	105G5941	1
2	Starting relay (overload protector MRT22AFZ-6)	117U4129	1
3	Starting capacitor (320 $\mu$ F 125V, 6.3mm)	117U5022	1
4	Cord relief	117U0349	1
5	Cover	117U1021	1
6	Bolt joint for one compressor   M6   $\varnothing$ 16mm	118-1917	1

Secop GmbH • Lise-Meitner-Straße 29 • 24941 Flensburg, Germany • Tel: +49 461 4941 0 • [www.secop.com](http://www.secop.com)

Secop accepts no responsibility for possible errors in catalogs, brochures, and other printed material. Secop reserves the right to alter its products without notice. This also applies to products already on order provided that such alterations can be made without subsequent changes being necessary to specifications already agreed. All trademarks in this material are the property of the respective companies. Secop and the Secop logotype are trademarks of Secop GmbH. All rights reserved.

## Model

Designation	<b>NF10FX</b>	115-127V/60Hz 1~	Sales code:	<b>105G5941</b>
-------------	---------------	------------------	-------------	-----------------

## Compressor design

Oil type	Polyolester	Refrigerant(s)	<b>R134a, R513A, 0</b>
Oil viscosity	32cST	Displacement	10,09cm <sup>3</sup> / 0,62cu.in
Oil quantity	298cm <sup>3</sup> / 10,1fl.oz	Compressors on pallet	80
Refr. charge - tech. limit	460g / 16,2oz		
Free gas volume comp.	2360cm <sup>3</sup> / 79,8fl.oz		
Weight	10kg / 22lbs		
Motor protection	external		
Winding resistance main	1,62Ω (at 25°C)		
Winding resistance aux	4,9Ω (at 25°C)		
Max. winding temp.	125°C / 257°F		
Max. discharge temp.	110°C / 230°F		



## General - Configurations with NF10FX

	<b>Conf. 1</b>	<b>Conf. 2</b>
Motorconfiguration	CSIR	CSIR
Power supply (nominal)	115-127V/60Hz	115-127V/60Hz
Number of phases	1	1
Voltage range	95-135V	95-135V
Approvals	UL, CCC, EAC	UL, CCC, EAC
Starting torque	HST	HST
Note	- / -	

## Applications with NF10FX

	<b>Conf. 1</b>	<b>Conf. 2</b>
Refrigerant	R134a	R513A
Application	LBP+MBP	LBP+MBP
System cooling	fan 1,5m/s	fan 1,5m/s
Hot gas defrost	OK	OK
Long interval pull down	OK	OK

## Electrical data - Configurations with NF10FX

	<b>Conf. 1</b>	<b>Conf. 2</b>
Starting device type	relay	relay
Run capacitor	- / -	- / -
Start capacitor	320μF	320μF
LRA (locked rotor amps / 4s/ U(N))	30,8A	30,8A
RLA (rated load amps / 1s/ U(N))	4,9A	4,9A
Cut in current (U(N))	30,8A	30,8A

## Model

Designation

**NF10FX**

115-127V/60Hz 1~

Sales code:

**105G5941**

## Compressor dimensions

Housing	A Height	197mm / 7,76in
	B Height	191mm / 7,52in
	C Length shell	205mm / 8,07in
	D Length w. cover	254mm / 10in
	E Width	166mm / 6,54in

Connectors		Suction	Discharge	Process
		X	Y	Z
Diameter	[mm]	øi 8,11-8,29	øi 6,41-6,59	øi 6,41-6,59
(i:inside, o:outside)	[in]	øi 0,32-0,33	øi 0,25-0,26	øi 0,25-0,26
Material		copper	copper	copper
Horizontal angle	±2°	0°	0°	0°
Vertical angle	±2°	15°	35°	155°
Position l/h/w	[mm]	126/76/78	133/103/54	-107/94/72
	[in]	4,9/3/3,1	5,2/4/2,1	-4,2/3,7/2,8
Straight tube l.	[mm]	12	12	12
	[in]	0,5	0,5	0,5

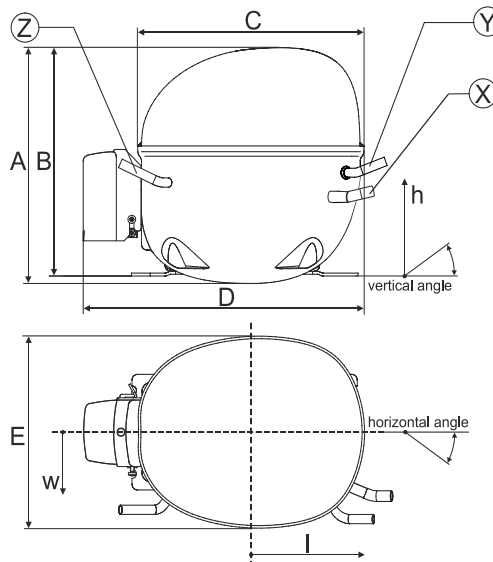

## Compressor fixation

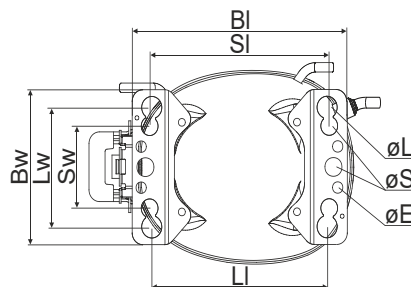

Baseplate	[mm]	[inch]
BI	204	8.03
Bw	132	5.2
øE	ø 9.7	ø 0.38
Large holes	[mm]	[inch]
LJ	165	6.5
Lw	101.6	4
øL	ø 19	ø 0.75
Small holes	[mm]	[inch]
SI	170	6.7
Sw	70	2.76
øS	ø 16	ø 0.63

## Bolt joint

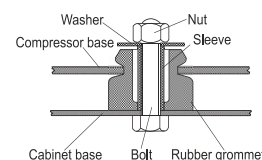

## Snap-on

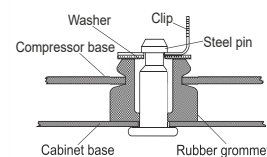

## Mounting accessories

Mounting accessories	one comp.	multi pack
Bolt joint   M6   ø16mm	118-1917	118-1918
Bolt joint   ø1/4"   ø16mm	118-1946	
Bolt joint   ø1/4"   ø19mm	118-1949	
Snap-on   ø7,3   ø16mm	118-1947	118-1919

## Application notes

Provision for PE Grounding is located at the PE Stamp on the compressor

## Model

Designation	<b>NF10FX</b>	<b>115-127V/60Hz</b>	<b>Conf. 1</b>	Sales code:	<b>105G5941</b>
-------------	---------------	----------------------	----------------	-------------	-----------------

## Configuration

Motor configuration	CSIR	
Power supply (nominal)	115-127V/60Hz 1~	
Refrigerant	R134a	
Application	LBP+MBP	
Voltage range	95-135V	
Starting torque	HST	
Approvals	UL	SA3693
	CCC	
	EAC	

## Electrical accessories / wiring diagram



## Ambient/ machine room temperatures minimum /maximum

Ambient temperature range:	10 - 43°C / 50 - 110°F
Machine room temperature range:	10 - 48°C / 50 - 119°F
Compressor cooling:	fan 3m/s

## Operation pressure range

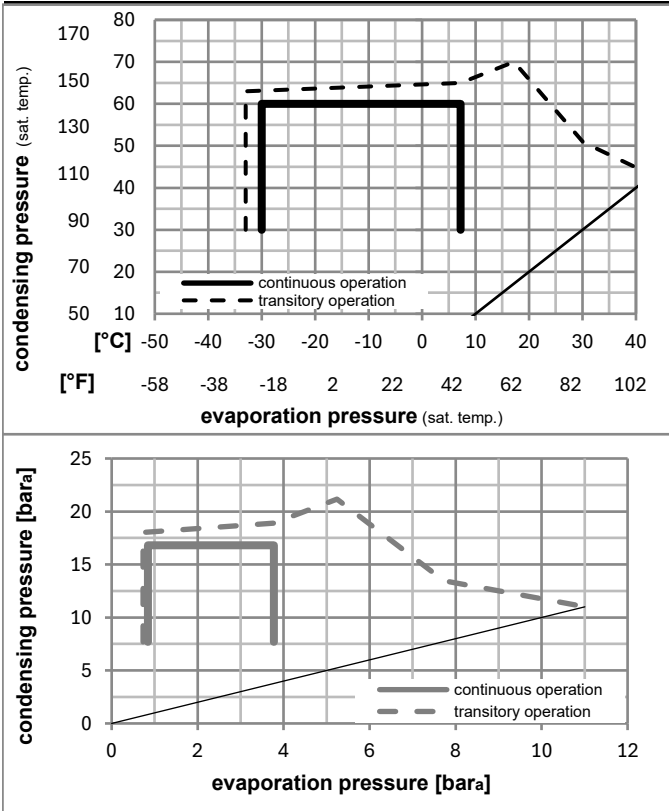

## Components

a2	current relay (MRT22AFZ-6)	117U4129
c	start capacitor (320µF)	117U5022
b	plastic cover	117U1021
d/dc	cord relief	117U0349
d/dc	cord relief	117U0349

### Model

Designation **NF10FX** **115-127V/60Hz** Conf. 1 Sales code: **105G5941**

### Optimization + standard conditions

R134a, 115V/60Hz, CSIR, fan 3m/s, UL, CCC, EAC

	Evaporating pressure (saturation temperature)				Cooling capacity			COP	EER	Power consumption			ASHRAE LBP	
	pe	pc	RGT	Tliq	[W]	[Btu/h]	[kcal/h]			P1	I	m		
[°C]	-23	54	32	32	306,9	1048	264,1	1,17	4,01	1,01	261,4	3,71	5,96	
[°F]	-10	130	90	90										
[°C]	-25	55	32	55	226,6	774	195,0	0,91	3,09	0,78	250,4	3,64	5,42	cecomaf LBP
[°F]	-13	131	90	131										
[°C]	-35	40	20	40	144,9	495	124,7	0,81	2,76	0,70	179,3	3,33	3,18	EN12900 LBP
[°F]	-31	104	68	104										
[°C]	-7	54	35	46	626,9	2141	539,5	1,60	5,48	1,38	390,7	4,55	13,68	ASHRAE MBP
[°F]	20	130	95	115										
[°C]	-10	55	32	55	488,2	1667	420,2	1,34	4,58	1,15	363,8	4,37	11,81	cecomaf MBP
[°F]	14	131	90	131										
[°C]	-10	45	20	45	541,0	1848	465,6	1,56	5,32	1,34	347,2	4,24	12,66	EN12900 MBP
[°F]	14	113	68	113										

### Performance tables

R134a, 115V/60Hz, CSIR, fan 3m/s, UL, CCC, EAC

	pe		Cooling capacity			COP	EER	P1	I	m	
	[°C]	[°F]	[W]	[Btu/h]	[kcal/h]						
[°C / °F]	-30	-22	189,5	647	163,1	0,89	3,05	0,77	212,3	3,46	4,10
cond. pressure	-23	-10	284,2	971	244,6	1,12	3,81	0,96	254,9	3,69	6,16
pc= 45/113	-15	5	441,6	1508	380,1	1,42	4,84	1,22	311,9	4,02	9,63
return gas temp.	-9	15	575,9	1967	495,6	1,64	5,60	1,41	351,1	4,26	12,61
RGT= 32/90	-4	25	737,6	2519	634,8	1,89	6,45	1,62	390,7	4,53	16,24
liquid temp	0	32	868,9	2967	747,8	2,08	7,09	1,79	418,3	4,73	19,21
Tliq= 45/113	7,2	45	1156,7	3950	995,4	2,47	8,43	2,13	468,4	5,13	25,84
[°C / °F]	-30	-22	165,4	565	142,4	0,76	2,59	0,65	218,5	3,43	3,94
cond. pressure	-23	-10	249,4	852	214,6	0,95	3,25	0,82	261,8	3,72	5,97
pc= 55/131	-15	5	385,5	1317	331,8	1,19	4,07	1,03	323,5	4,11	9,28
return gas temp	-9	15	500,7	1710	430,9	1,36	4,64	1,17	368,4	4,40	12,11
RGT= 32/90	-4	25	639,4	2184	550,3	1,54	5,26	1,32	415,6	4,72	15,56
liquid temp	0	32	752,3	2569	647,5	1,67	5,71	1,44	449,6	4,95	18,40
Tliq= 55/131	7,2	45	1000,9	3418	861,4	1,95	6,65	1,68	514,2	5,40	24,76

## Model

Designation	<b>NF10FX</b>	<b>115-127V/60Hz</b>	<b>Conf. 2</b>	Sales code:	<b>105G5941</b>
-------------	---------------	----------------------	----------------	-------------	-----------------

## Configuration

Motor configuration	CSIR	
Power supply (nominal)	115-127V/60Hz 1~	
Refrigerant	R513A	
Application	LBP+MBP	
Voltage range	95-135V	
Starting torque	HST	
Approvals	UL	SA3693
	CCC	
	EAC	

## Electrical accessories / wiring diagram

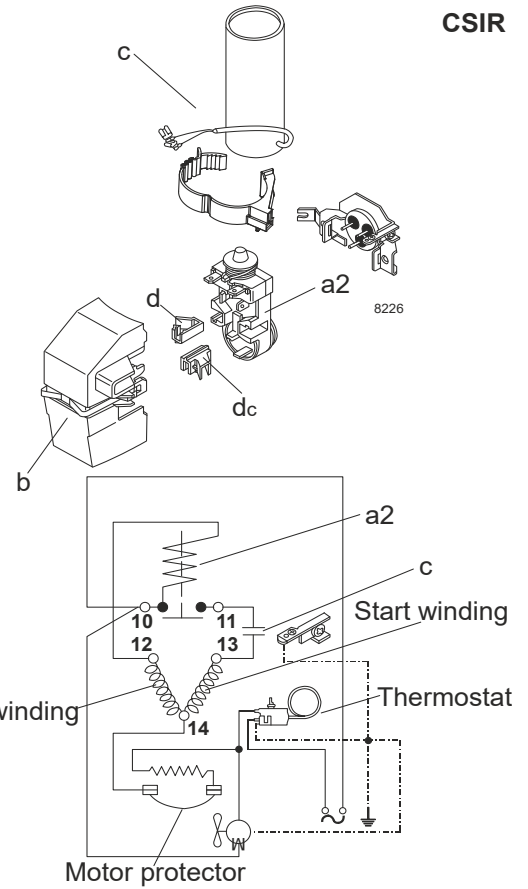

## Ambient/ machine room temperatures minimum /maximum

Ambient temperature range:	10 - 43°C / 50 - 110°F
Machine room temperature range:	10 - 48°C / 50 - 119°F
Compressor cooling:	fan 3m/s

## Operation pressure range

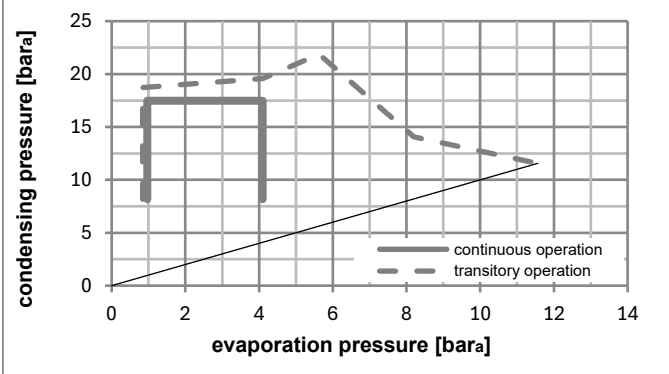
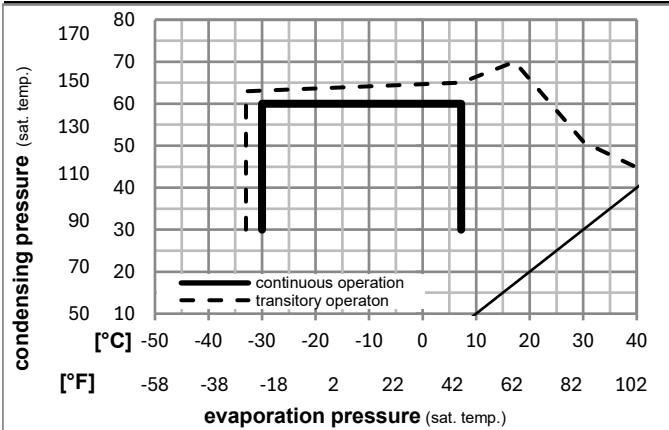

## Components

a2	current relay ( MRT22AFZ-6)	117U4129
c	start capacitor (320µF)	117U5022
b	plastic cover	117U1021
d/dc	cord relief	117U0349
d/dc	cord relief	117U0349

### Model

Designation **NF10FX** **115-127V/60Hz** Conf. 2 Sales code: **105G5941**

### Optimization + standard conditions

R513A, 115V/60Hz, CSIR, fan 3m/s, UL, CCC, EAC

	Evaporating pressure (saturation temperature)				Cooling capacity			COP	EER	P1	Power consumption		ASHRAE LBP	
	pe	pc	RGT	Tliq	[W]	[Btu/h]	[kcal/h]				I	m		
	[°C]	[°F]	[°C]	[°F]	[W]	[Btu/h]	[kcal/h]	[W/W]	[Btu/Wh]	[kcal/Wh]	[W]	[A]	[kg/h]	
	-23	54	32	32	338,9	1157	291,6	1,19	4,05	1,02	285,9	3,92	7,29	ASHRAE LBP
	-10	130	90	90										
	-25	55	32	55	243,4	831	209,5	0,89	3,02	0,76	275,0	3,85	6,67	cecomaf LBP
	-13	131	90	131										
	-35	40	20	40	161,5	552	139,0	0,81	2,78	0,70	198,2	3,36	3,99	EN12900 LBP
	-31	104	68	104										
	-7	54	35	46	657,3	2245	565,7	1,58	5,39	1,36	416,4	4,76	16,10	ASHRAE MBP
	20	130	95	115										
	-10	55	32	55	506,0	1728	435,5	1,30	4,44	1,12	389,2	4,58	13,99	cecomaf MBP
	14	131	90	131										
	-10	45	20	45	564,9	1929	486,1	1,52	5,20	1,31	370,7	4,47	14,97	EN12900 MBP
	14	113	68	113										

### Performance tables

R513A, 115V/60Hz, CSIR, fan 3m/s, UL, CCC, EAC

	pe		Cooling capacity			COP	EER	P1	I	m	
	[°C]	[°F]	[W]	[Btu/h]	[kcal/h]						
[°C / °F]	-30	-22	208,9	714	179,8	0,89	3,06	0,77	233,5	3,59	5,08
cond. pressure	-23	-10	307,5	1050	264,6	1,11	3,79	0,96	276,9	3,87	7,50
pc= 45/113	-15	5	469,1	1602	403,7	1,40	4,78	1,21	334,9	4,24	11,49
return gas temp.	-9	15	605,5	2068	521,1	1,62	5,52	1,39	374,7	4,49	14,89
RGT= 32/90	-4	25	768,5	2625	661,4	1,85	6,33	1,59	414,7	4,75	18,99
liquid temp	0	32	900,2	3074	774,7	2,04	6,95	1,75	442,3	4,92	22,33
Tliq= 45/113	7,2	45	1187,3	4055	1021,8	2,41	8,24	2,08	492,0	5,24	29,70
[°C / °F]	-30	-22	180,8	617	155,6	0,74	2,54	0,64	243,2	3,65	4,94
cond. pressure	-23	-10	266,6	911	229,5	0,93	3,18	0,80	286,4	3,93	7,31
pc= 55/131	-15	5	403,7	1379	347,4	1,16	3,96	1,00	348,5	4,32	11,12
return gas temp	-9	15	518,4	1770	446,1	1,32	4,49	1,13	393,9	4,61	14,34
RGT= 32/90	-4	25	655,5	2239	564,1	1,48	5,07	1,28	441,5	4,92	18,23
liquid temp	0	32	766,5	2618	659,6	1,61	5,50	1,39	475,9	5,14	21,41
Tliq= 55/131	7,2	45	1009,7	3448	868,9	1,87	6,37	1,61	540,9	5,56	28,46



8238-23

# NF Compressors



8230-2



8226-2





8238-23

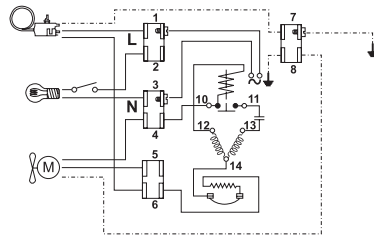
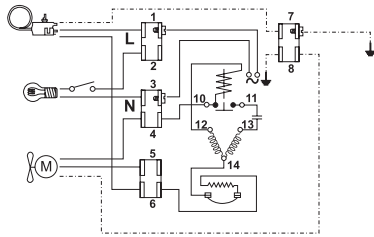

Secop accepts no responsibility for possible errors in catalogs, brochures, and other printed material. Secop reserves the right to alter its products without notice. This also applies to products already on order provided that such alterations can be made without subsequential changes being necessary to specifications already agreed. All trademarks in this material are the property of the respective companies. Secop and the Secop logotype are trademarks of Secop GmbH. All rights reserved. [www.secop.com](http://www.secop.com)