

Single Pack NL9CN 220-240V 50Hz CSIR

Single pack code number: **195B4540**

Position	Title	Code	Amount
1	Compressor NL9CN	105H6856	1
2	Starting relay	117U7002	1
3	Starting capacitor (80 μ F 220V, 6.3mm)	117U5015	1
4	Cord relief	103N1010	1
5	Cover	103N2011	1
6	Bolt joint for one compressor M6 \varnothing 16mm	118-1917	1

Secop GmbH • Lise-Meitner-Straße 29 • 24941 Flensburg, Germany • Tel: +49 461 4941 0 • www.secop.com

Secop accepts no responsibility for possible errors in catalogs, brochures, and other printed material. Secop reserves the right to alter its products without notice. This also applies to products already on order provided that such alterations can be made without subsequent changes being necessary to specifications already agreed. All trademarks in this material are the property of the respective companies. Secop and the Secop logotype are trademarks of Secop GmbH. All rights reserved.

NL9CN LBP/MBP Compressor R290 220-240V 50Hz

General

Code number	105H6856
Approvals	EN 60335-2-34 w. Annex AA, CCC
Compressors on pallet	80

Application

Application	LBP/MBP		
Frequency	Hz	50	60
Evaporating temperature	°C	-40 to 5	-
Voltage range	V	198 - 254	-
Max. condensing temperature continuous (short)	°C	55 (65)	-
Max. winding temperature continuous (short)	°C	125 (135)	-

Cooling requirements

Frequency	Hz	50			60		
Application		LBP	MBP	HBP	LBP	MBP	HBP
32°C		F ₁	F ₁	-	-	-	-
38°C		F ₁	F ₁	-	-	-	-
43°C		F ₂	F ₂	-	-	-	-

Remarks on application: Run capacitor 4 µF compulsory in 43°C ambient temperature at MBP conditions.

Motor

Motor type	RSIR/RSCR/CSIR		
LRA (rated after 4 sec. UL984), HST LST	A	10.4	9.2
Cut in Current, HST LST	A	10.4	13.6
Resistance, main start winding (25°C)	Ω	8.2	14.7

Design

Displacement	cm ³	8.35
Oil quantity (type)	cm ³	270 (polyolester)
Maximum refrigerant charge	g	150
Free gas volume in compressor	cm ³	2360
Weight without electrical equipment	kg	10.5

Dimensions

Height	mm	A	203
		B	197
		B1	-
		B2	-
Suction connector	location/I.D. mm angle	C	8.2 15°
	material comment		Copper Rubber plug
Process connector	location/I.D. mm angle	D	6.2 25°
	material comment		Copper Rubber plug
Discharge connector	location/I.D. mm angle	E	6.2 35°
	material comment		Copper Rubber plug
Oil cooler connector	location/I.D. mm angle	F	-
	material comment		-
Connector tolerance	I.D. mm		±0.09
Remarks:			

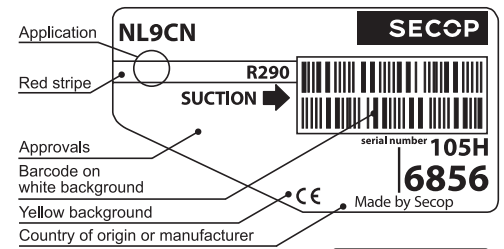

Yellow warning label

- S = Static cooling normally sufficient
- O = Oil cooling
- F₁ = Fan cooling 1.5 m/s (compressor compartment temperature equal to ambient temperature)
- F₂ = Fan cooling 3.0 m/s necessary
- SG = Suction gas cooling normally sufficient
- = not applicable in this area

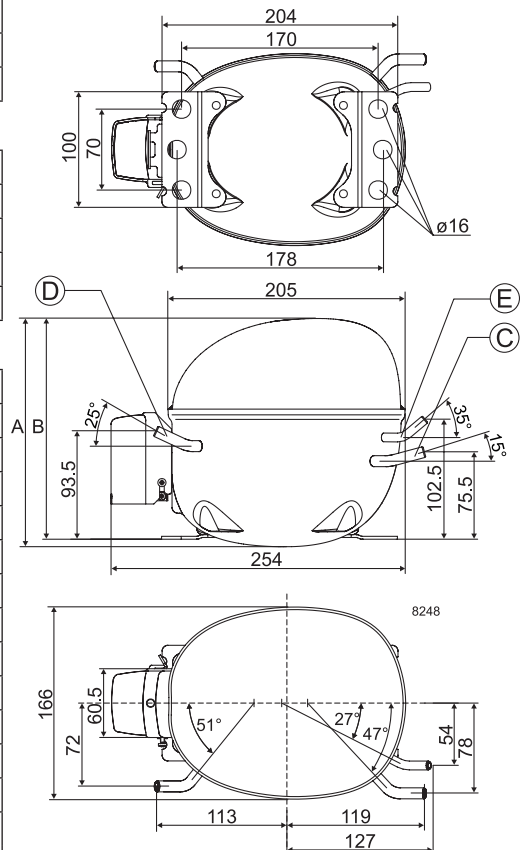

EN 12900 Household (CECOMAF)* 220V, 50Hz, 2 W PTC consumption incl., fan cooling F₁

Evap. temp. in °C	-45	-40	-35	-30	-25	-23.3	-20	-15	-10	-6.7	-5	0	5	7.2	10	15	20
Capacity in W		138	194	259	335	364	423	526	643	730	778	930	1102				
Power cons. in W		169	196	223	250	259	278	306	334	354	364	395	428				
Current cons. in A		1.44	1.50	1.56	1.64	1.67	1.73	1.83	1.95	2.03	2.08	2.21	2.36				
COP in W/W		0.81	0.99	1.16	1.34	1.40	1.53	1.72	1.92	2.06	2.13	2.35	2.58				

ASHRAE LBP* 220V, 50Hz, 2 W PTC consumption incl., fan cooling F₁

Evap. temp. in °C	-45	-40	-35	-30	-25	-23.3	-20	-15	-10	-6.7	-5	0	5	7.2	10	15	20
Capacity in W		153	216	289	374	406	473	587	719	816	869	1041	1235				
Power cons. in W		169	196	223	250	259	278	306	334	354	364	395	428				
Current cons. in A		1.44	1.50	1.56	1.64	1.67	1.73	1.83	1.95	2.03	2.08	2.21	2.36				
COP in W/W		0.91	1.10	1.29	1.49	1.56	1.70	1.92	2.15	2.30	2.39	2.63	2.89				

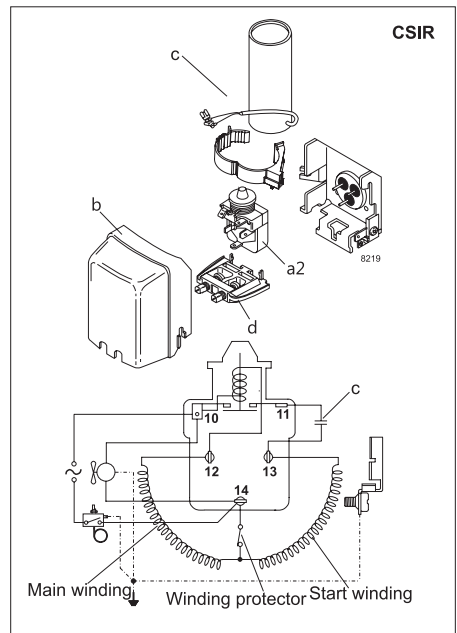
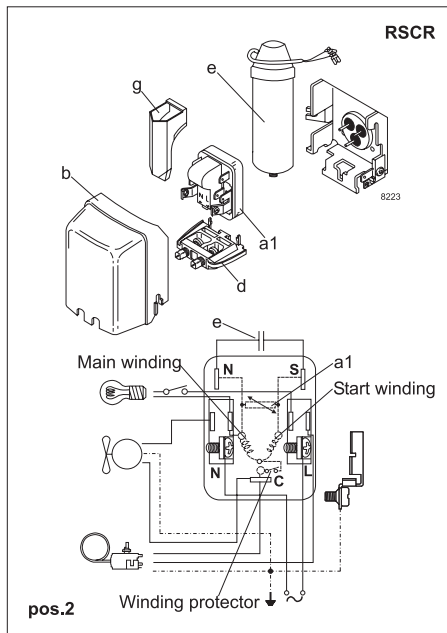

Accessories for	NL9CN	Figure	Code number
PTC starting device	6.3 mm spade connectors	a1	103N0011
	4.8 mm spade connectors	(pos.1)	103N0018
PTC starting device	6.3 mm spade connectors	a1	103N0016
	4.8 mm spade connectors	(pos.2)	103N0021
Starting relay	6.3 mm spade connectors	a2	117U7002
Start. capacitor 80 µF	6.3 mm spade connectors	c	117U5015
Cover		b	103N2010
Cord relief		d	103N1010
Run capacitor 4 µF (optional)	6.3 mm spade connectors	e	117-7117
	4.8 mm spade connectors	e	117-7119
Protection screen for PTC		g	103N0476

Test conditions	EN 12900/CECOMAF*	ASHRAE LBP*
Condensing temperature	45°C	45°C
Ambient temperature	32°C	32°C
Suction gas temperature	32°C	32°C
Liquid temperature	no subcooling	32°C

Mounting accessories	Code number	
Bolt joint for one comp.	Ø: 16 mm	118-1917
Bolt joint in quantities	Ø: 16 mm	118-1918
Snap-on in quantities	Ø: 16 mm	118-1919

Secop accepts no responsibility for possible errors in catalogs, brochures, and other printed material. Secop reserves the right to alter its products without notice. This also applies to products already on order provided that such alterations can be made without subsequential changes being necessary to specifications already agreed. All trademarks in this material are the property of the respective companies. Secop and the Secop logotype are trademarks of Secop GmbH. All rights reserved. www.secop.com



NL Compressors





Service/Repair – R600a, R290



8545

Brazing on Suction Connectors (Direct Intake)

representative image



**! max. 150°C/302°F !
at socket**
brazing solder: phosphor (LP7) or silver

Refer to Product Bulletin:
**Brazing on Suction Connectors
(Compressors with Direct Suction Intake)**

Secop accepts no responsibility for possible errors in catalogs, brochures, and other printed material. Secop reserves the right to alter its products without notice. This also applies to products already on order provided that such alterations can be made without subsequential changes being necessary to specifications already agreed. All trademarks in this material are the property of the respective companies. Secop and the Secop logotype are trademarks of Secop GmbH. All rights reserved. www.secop.com