

Single Pack HXK55AA 220-240V 50Hz RSCR

Single pack code number: **195B4603**

Position	Title	Code	Amount
1	Compressor HXK55AA	15650400	1
2	Screw for cable clamp	10636000	1
3	Screw for cable clamp	10636200	1
4	Cover	10636401	1
5	Rubber grommet 16.5mm	10639900	4
6	Sleeve	10640100	4
7	Earth screw	10641201	1
8	Run capacitor (3 μ F 420V, 4.8mm)	10693200	1
9	Cable clamp	11341000	1
10	e-PTC starting device (240V, overload protector AE25FJ6)	15624200	1

Secop GmbH • Lise-Meitner-Straße 29 • 24941 Flensburg, Germany • Tel: +49 461 4941 0 • www.secop.com

Secop accepts no responsibility for possible errors in catalogs, brochures, and other printed material. Secop reserves the right to alter its products without notice. This also applies to products already on order provided that such alterations can be made without subsequent changes being necessary to specifications already agreed. All trademarks in this material are the property of the respective companies. Secop and the Secop logotype are trademarks of Secop GmbH. All rights reserved.

Model

Designation	HXK55AA	220-240V/50Hz 1~	Sales code:	15650400
-------------	----------------	------------------	-------------	-----------------

Compressor design

Oil type	Mineral	Refrigerant(s)	R600a
Oil viscosity	5cSt	Displacement	5,6cm ³ / 0,34cu.in
Oil quantity	162cm ³ / 5,5fl.oz	Compressors on pallet	100
Refr. charge - tech. limit	150g / 5,3oz		
Free gas volume comp.	1500cm ³ / 50,7fl.oz		
Weight	8,5kg / 18,7lbs		
Motor protection	external		
Winding resistance main	35,2Ω (at 25°C)		
Winding resistance aux	23,1Ω (at 25°C)		
Max. winding temp.	130°C / 266°F		
Max. discharge temp.	130°C / 266°F		



General - Configurations with HXK55AA

	Conf. 1	Conf. 2
Motorconfiguration	eRSCR	RSCR
Power supply (nominal)	220-240V/50Hz	220-240V/50Hz
Number of phases	1	1
Voltage range	187-264V	187-264V
Approvals	VDE	VDE
Starting torque	LST	LST
Note	E-PTC is 1.5W more energy efficient - same polynomial	

Applications with HXK55AA

	Conf. 1	Conf. 2
Refrigerant	R600a	R600a
Application	LBP	LBP
System cooling	static	static
Hot gas defrost	-/-	-/-
Long interval pull down	-/-	-/-

Electrical data - Configurations with HXK55AA

	Conf. 1	Conf. 2
Starting device type	e-PTC	PTC
Run capacitor	3μF	3μF
Start capacitor	-/-	-/-
LRA (locked rotor amps / 4s/ U(N))		
RLA (rated load amps / 1s/ U(N))	-/-A	-/-A
Cut in current (U(N))		

Model

Designation

HXK55AA

220-240V/50Hz 1~

Sales code:

15650400

Compressor dimensions

Housing	A Height	166mm / 6,54in
	B Height	159mm / 6,26in
	C Length shell	194mm / 7,64in
	D Length w. cover	238mm / 9,37in
	E Width	151mm / 5,94in

Connectors		Suction	Discharge	Process
		X	Y	Z
Diameter	[mm]	øi 6,1-6,2	øi 5,1-5,2	øo 5,92-6,08
(i:inside, o:outside)	[in]	øi 0,24-0,24	øi 0,2-0,2	øo 0,23-0,24
Material		copper	copper	copper
Horizontal angle	±2°	45°	13°	0°
Vertical angle	±2°	30°	40°	145°
Position l/h/w	[mm]	120/72/62	112/106/62	-140/136/70
	[in]	4,7/2,8/2,4	4,4/4,2/2,4	-5,5/5,4/2,8
Straight tube l.	[mm]	14	14	75
	[in]	0,5	0,5	3

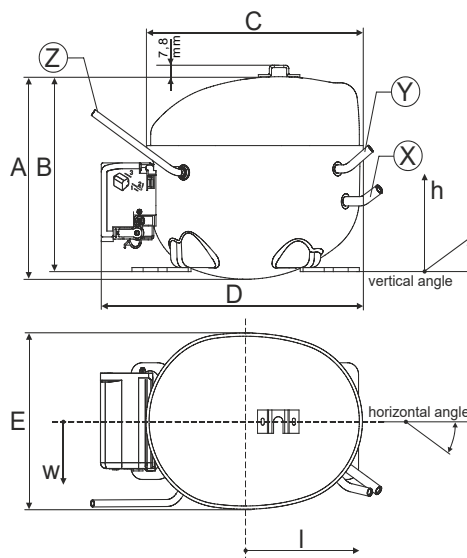

Compressor fixation

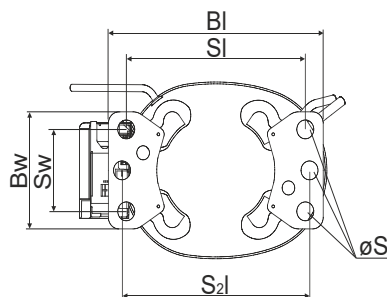

Baseplate	[mm]	[inch]
BI	204	8.03
Bw	100	3.94

Small holes	[mm]	[inch]
SI	170	6.7
Sw	70	2.76
S2l	178	7
øS	ø 16	ø 0.63

Bolt joint

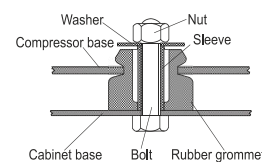

Snap-on

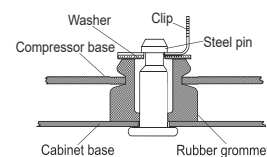

Mounting accessories

'4ZN' with rubber grommet

'4ZN' with rubber grommet and sleeve for M6

Bolt joint kit

'4ZN' with Snap on kit

order code

772N

768N

4ZN + 118-1917 (18)

776N

Application notes

Provision for PE Grounding is located at the PE Stamp on the compressor

Housing with dip-tray fixture (omega bracket).

Various options of connectors are possible - please contact SECOP-Sales.

Model

Designation	HXK55AA	220-240V/50Hz	Conf. 1	Sales code:	15650400
-------------	----------------	----------------------	----------------	-------------	-----------------

Configuration

Motorconfiguration	eRSCR
Power supply (nominal)	220-240V/50Hz 1~
Refrigerant	R600a
Application	LBP
Voltage range	187-264V
Starting torque	LST
Approvals	VDE

Electrical accessories / wiring diagram

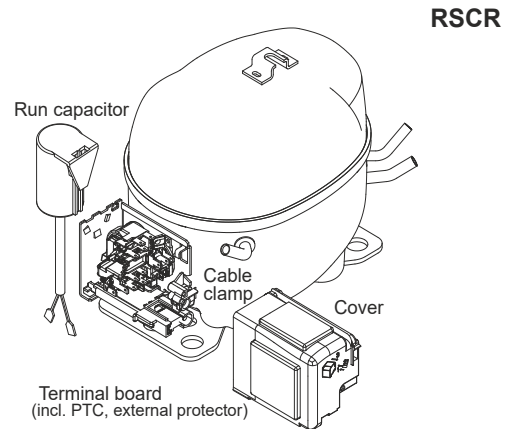

Ambient/ machine room temperatures minimum /maximum

Ambient temperature range:	10 - 43°C / 50 - 110°F
Machine room temperature range:	10 - 48°C / 50 - 119°F
Compressor cooling:	static

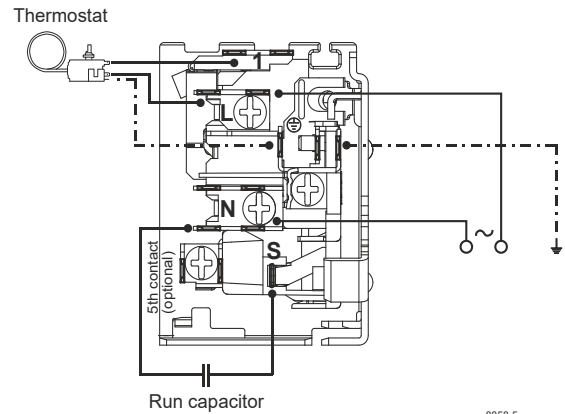

Operation pressure range

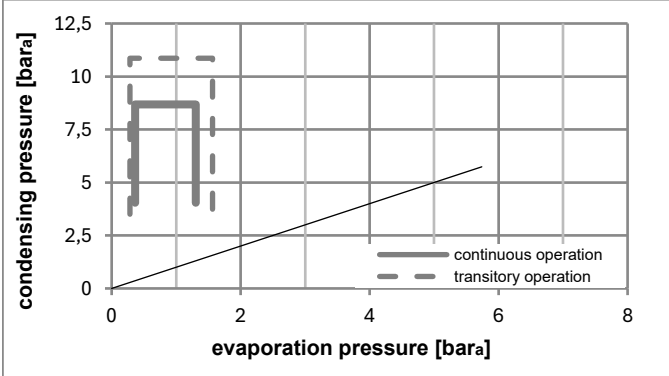
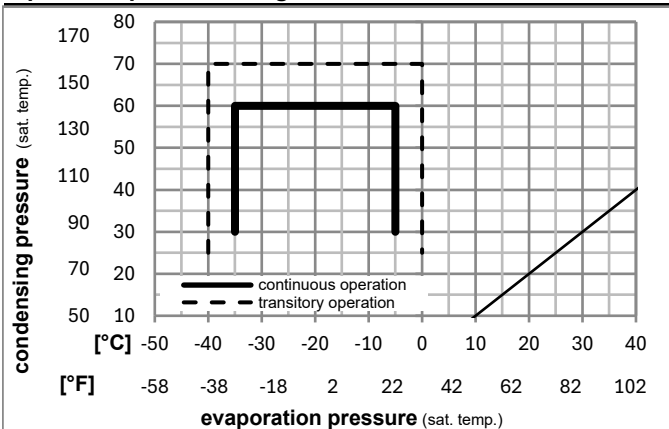

Components

. terminal board (e-PTC, 4.8mm)	15624200
. run capacitor (3μF, 4.8mm)	10693200
b cover terminal board	10636401
. Cable clamp (screws not included)	11341000
. screw - uni6954	10636000
. screw - uni6954	10636200

Alternative components

. screw uni en iso 4757	10641201
-------------------------	----------

Model

Designation **HXK55AA** **220-240V/50Hz** Conf. 1 Sales code: **15650400**

Optimization + standard conditions

R600a, 220V/50Hz, eRSCR, static, VDE

	pe	pc	RGT	Tliq	Cooling capacity	COP	EER	P1	I	Ref. mass flow	
	[°C]	[°C]	[°C]	[°C]	[W]	[W/W]	[Btu/Wh]	[W]	[A]	[kg/h]	
	-23	54	32	32	96,9	1,83	6,24	53,0	0,25	1,04	ASHRAE LBP
	-10	130	90	90							
	-25	55	32	55	72,0	1,43	4,89	50,3	0,24	0,94	cecomaf LBP
	-13	131	90	131							
	-35	40	20	40	47,6	1,32	4,51	36,0	0,20	0,58	EN12900 LBP
	-31	104	68	104							
	-23	49	4,4	49	80,7	1,54	5,27	52,4	0,25	1,18	ARI540 LBP
	-10	120	40	120							
	-23	41	32	32	110,1	2,13	7,28	51,6	0,24	1,18	AHAM LBP
	-10	105	90	90							
	-35	45	32	45	44,6	1,26	4,29	35,5	0,20	0,53	opt
	-31	113	90	113							

Performance tables

R600a, 220V/50Hz, eRSCR, static, VDE

	pe	Cooling capacity			COP	EER	P1	I	m		
	[°C]	[°F]	[W]	[Btu/h]	[kcal/h]	[W/W]	[Btu/Wh]	[kcal/Wh]	[W]	[A]	[kg/h]
[°C / °F]	-35	-31	44,6	152	38,3	1,26	4,29	1,08	35,5	0,20	0,53
cond. pressure	-30	-22	64,6	221	55,6	1,51	5,16	1,30	42,7	0,22	0,77
pc= 45/113	-25	-13	87,3	298	75,2	1,76	6,00	1,51	49,7	0,24	1,04
return gas temp.	-23	-10	95,7	327	82,3	1,84	6,28	1,58	52,0	0,24	1,14
RGT= 32/90	-20	-4	112,8	385	97,1	2,00	6,83	1,72	56,4	0,26	1,34
liquid temp	-15	5	140,9	481	121,3	2,24	7,66	1,93	62,8	0,28	1,68
Tliq= 45/113	-5	23	205,3	701	176,7	2,75	9,39	2,37	74,7	0,33	2,46
[°C / °F]	-35	-31	35,9	122	30,9	1,06	3,62	0,91	33,9	0,19	0,47
cond. pressure	-30	-22	52,3	178	45,0	1,24	4,25	1,07	42,0	0,21	0,68
pc= 55/131	-25	-13	72,0	246	62,0	1,43	4,89	1,23	50,3	0,24	0,94
return gas temp	-23	-10	79,5	271	68,4	1,49	5,10	1,29	53,2	0,25	1,04
RGT= 32/90	-20	-4	95,1	325	81,8	1,62	5,52	1,39	58,8	0,27	1,24
liquid temp	-15	5	121,4	415	104,5	1,80	6,15	1,55	67,5	0,30	1,59
Tliq= 55/131	-5	23	183,9	628	158,3	2,16	7,37	1,86	85,2	0,36	2,42

Model

Designation	HXK55AA	220-240V/50Hz	Conf. 2	Sales code:	15650400
-------------	----------------	----------------------	----------------	-------------	-----------------

Configuration

Motorconfiguration	RSCR
Power supply (nominal)	220-240V/50Hz 1~
Refrigerant	R600a
Application	LBP
Voltage range	187-264V
Starting torque	LST
Approvals	VDE

Electrical accessories / wiring diagram

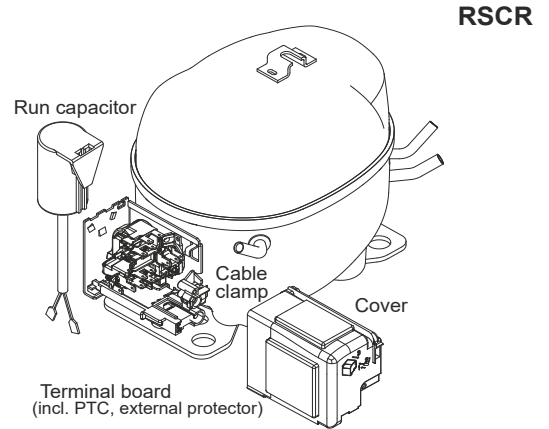

Ambient/ machine room temperatures minimum /maximum

Ambient temperature range:	10 - 43°C / 50 - 110°F
Machine room temperature range:	10 - 48°C / 50 - 119°F
Compressor cooling:	static

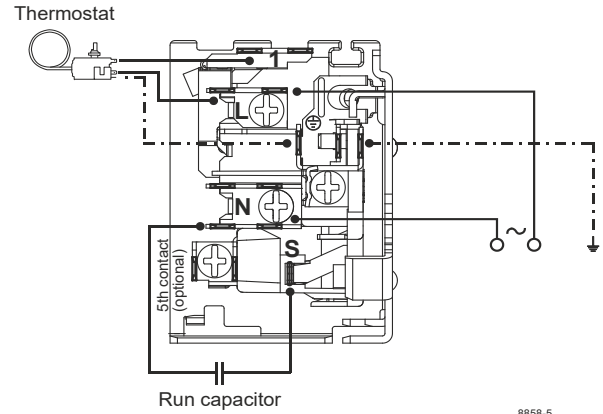

Operation pressure range

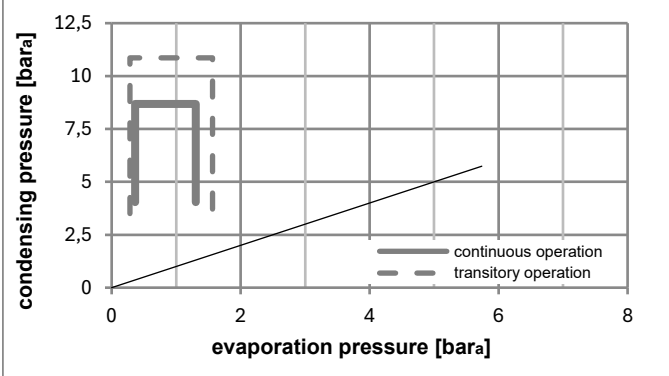
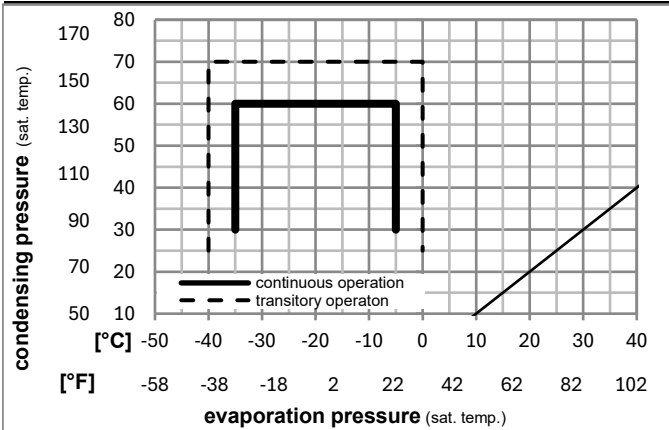

Components

. terminal board (PTC, 6.3mm)	15162200
. run capacitor (3μF, 6.3mm)	15312801
b cover terminal board	10636401
. Cable clamp (screws not included)	11341000
. screw - uni6954	10636000
. screw - uni6954	10636200

Alternative components

. screw uni en iso 4757	10641201
-------------------------	----------

Model

Designation **HXK55AA** **220-240V/50Hz** Conf. 2 Sales code: **15650400**

Optimization + standard conditions

R600a, 220V/50Hz, RSCR, static, VDE

	Evaporating pressure (saturation temperature)				Cooling capacity	COP	EER	Power consumption			ASHRAE LBP	
	pe	pc	RGT	Tliq				P1	I	m		
	[°C]	[°C]	[°C]	[°C]	[W]	[W/W]	[Btu/Wh]	[kcal/Wh]	[W]	[A]	[kg/h]	
	-23	54	32	32	96,9	1,83	6,24	1,57	53,0	0,25	1,04	
	[°F]											
	-10	130	90	90								
	-25	55	32	55	72,0	1,43	4,89	1,23	50,3	0,24	0,94	cecomaf LBP
	[°F]											
	-13	131	90	131								
	-35	40	20	40	47,6	1,32	4,51	1,14	36,0	0,20	0,58	EN12900 LBP
	[°F]											
	-31	104	68	104								
	-23	49	4,4	49	80,7	1,54	5,27	1,33	52,4	0,25	1,18	ARI540 LBP
	[°F]											
	-10	120	40	120								
	-23	41	32	32	110,1	2,13	7,28	1,83	51,6	0,24	1,18	AHAM LBP
	[°F]											
	-10	105	90	90								
	-35	45	32	45	44,6	1,26	4,29	1,08	35,5	0,20	0,53	opt
	[°F]											
	-31	113	90	113								

Performance tables

R600a, 220V/50Hz, RSCR, static, VDE

	pe		Cooling capacity			COP	EER		P1	I	m
	[°C]	[°F]	[W]	[Btu/h]	[kcal/h]	[W/W]	[Btu/Wh]	[kcal/Wh]	[W]	[A]	[kg/h]
[°C / °F]	-35	-31	44,6	152	38,3	1,26	4,29	1,08	35,5	0,20	0,53
cond. pressure	-30	-22	64,6	221	55,6	1,51	5,16	1,30	42,7	0,22	0,77
pc= 45/113	-25	-13	87,3	298	75,2	1,76	6,00	1,51	49,7	0,24	1,04
return gas temp.	-23	-10	95,7	327	82,3	1,84	6,28	1,58	52,0	0,24	1,14
RGT= 32/90	-20	-4	112,8	385	97,1	2,00	6,83	1,72	56,4	0,26	1,34
liquid temp	-15	5	140,9	481	121,3	2,24	7,66	1,93	62,8	0,28	1,68
Tliq= 45/113	-5	23	205,3	701	176,7	2,75	9,39	2,37	74,7	0,33	2,46
[°C / °F]	-35	-31	35,9	122	30,9	1,06	3,62	0,91	33,9	0,19	0,47
cond. pressure	-30	-22	52,3	178	45,0	1,24	4,25	1,07	42,0	0,21	0,68
pc= 55/131	-25	-13	72,0	246	62,0	1,43	4,89	1,23	50,3	0,24	0,94
return gas temp	-23	-10	79,5	271	68,4	1,49	5,10	1,29	53,2	0,25	1,04
RGT= 32/90	-20	-4	95,1	325	81,8	1,62	5,52	1,39	58,8	0,27	1,24
liquid temp	-15	5	121,4	415	104,5	1,80	6,15	1,55	67,5	0,30	1,59
Tliq= 55/131	-5	23	183,9	628	158,3	2,16	7,37	1,86	85,2	0,36	2,42



K-Series Compressors

GTK, HKK, HMK, HTK, HXK, HZK



Service/Repair – R600a



K-Series Compressors

GTK, HKK, HMK, HTK, HXK, HZK



Service/Repair – R600a

Secop accepts no responsibility for possible errors in catalogs, brochures, and other printed material. Secop reserves the right to alter its products without notice. This also applies to products already on order provided that such alterations can be made without subsequential changes being necessary to specifications already agreed. All trademarks in this material are the property of the respective companies. Secop and the Secop logotype are trademarks of Secop GmbH. All rights reserved. www.secop.com