

Single Pack HXK87AT 200-240V 50Hz / 208-230V 60Hz RSIR

Single pack code number: **195B4618**

Position	Title	Code	Amount
1	Compressor HXK87AT	16408900	1
2	Clip	10633900	4
3	Steel pin	10634100	4
4	Washer	10634300	4
5	Screw for cable clamp	10636000	1
6	Screw for cable clamp	10636200	1
7	Cover	10636401	1
8	Earth screw	10641201	1
9	Rubber grommet 16mm	11322600	4
10	Cable clamp	11341000	1
11	Terminal board 6.3mm	16403700	1

Secop GmbH • Lise-Meitner-Straße 29 • 24941 Flensburg, Germany • Tel: +49 461 4941 0 • www.secop.com

Secop accepts no responsibility for possible errors in catalogs, brochures, and other printed material. Secop reserves the right to alter its products without notice. This also applies to products already on order provided that such alterations can be made without subsequent changes being necessary to specifications already agreed. All trademarks in this material are the property of the respective companies. Secop and the Secop logotype are trademarks of Secop GmbH. All rights reserved.

Model

Designation	HXK87AT	220-240V/50Hz 1~	Sales code:	16408900
-------------	----------------	-------------------------	-------------	-----------------

Compressor design

Oil type	Mineral	Refrigerant(s)	R600a
Oil viscosity	5cST	Displacement	8,8cm ³ / 0,54cu.in
Oil quantity	162cm ³ / 5,5fl.oz	Compressors on pallet	100
Refr. charge - tech. limit	150g / 5,3oz		
Free gas volume comp.	1620cm ³ / 54,8fl.oz		
Weight	8,6kg / 19lbs		
Motor protection	external		
Winding resistance main	18,8Ω (at 25°C)		
Winding resistance aux	10,7Ω (at 25°C)		
Max. winding temp.	130°C / 266°F		
Max. discharge temp.	130°C / 266°F		



General - Configurations with HXK87AT

	Conf. 1	Conf. 2	Conf. 3	Conf. 4
Motorconfiguration	RSCR	RSIR	RSCR	RSCR
Power supply (nominal)	200-240V/50Hz	200-240V/50Hz	220-240V/50Hz	208-230V/60Hz
Number of phases	1	1	1	1
Voltage range	170-264V	170-264V	170-264V	198-253V
Approvals	VDE	VDE	VDE	VDE
Starting torque	LST	LST	LST	LST
Note	Various options of connectors are possible - please contact SECOP-Sales.			

Applications with HXK87AT

	Conf. 1	Conf. 2	Conf. 3	Conf. 4
Refrigerant	R600a	R600a	R600a	R600a
Application	LBP	LBP	LBP	LBP
System cooling	static	static	static	static
Hot gas defrost	-/-	-/-	-/-	-/-
Long interval pull down	-/-	-/-	-/-	-/-

Electrical data - Configurations with HXK87AT

	Conf. 1	Conf. 2	Conf. 3	Conf. 4
Starting device type	PTC	PTC	PTC	PTC
Run capacitor	4μF	-/-	4μF	4μF
Start capacitor	-/-	-/-	-/-	-/-
LRA (locked rotor amps / 4s/ U(N))				
RLA (rated load amps / 1s/ U(N))	-/-A	-/-A		-/-A
Cut in current (U(N))				

Model

Designation

HXK87AT

220-240V/50Hz 1~

Sales code:

16408900

Compressor dimensions

Housing	A Height	174mm / 6,85in
	B Height	167mm / 6,57in
	C Length shell	194mm / 7,64in
	D Length w. cover	238mm / 9,37in
	E Width	151mm / 5,94in

Connectors		Suction	Discharge	Process
		X	Y	Z
Diameter	[mm]	øi 6,1-6,2	øi 5,1-5,2	øo 5,92-6,08
	(i:inside, o:outside) [in]	øi 0,24-0,24	øi 0,2-0,2	øo 0,23-0,24
Material		copper	copper	copper
Horizontal angle	±2°	45°	13°	0°
Vertical angle	±2°	30°	40°	145°
Position l/h/w	[mm]	120/72/62	112/106/62	-140/136/70
	[in]	4,7/2,8/2,4	4,4/4,2/2,4	-5,5/5,4/2,8
Straight tube l.	[mm]	14	14	75
	[in]	0,5	0,5	3

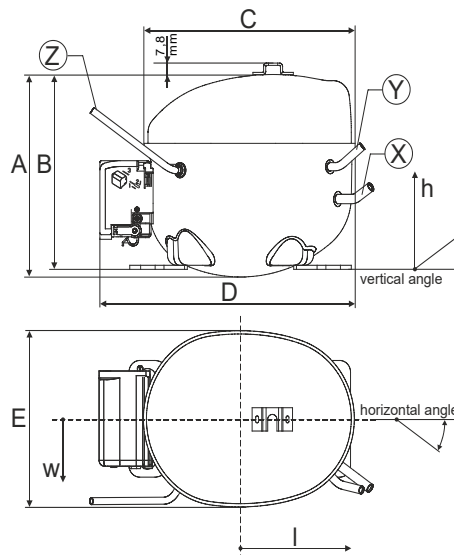

Compressor fixation

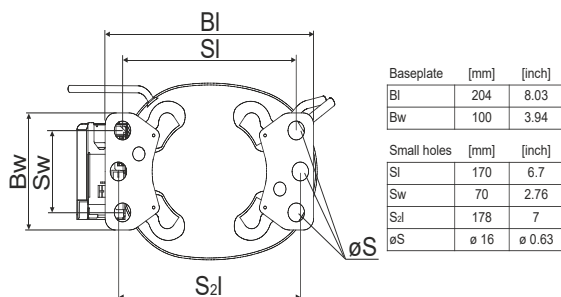

Bolt joint

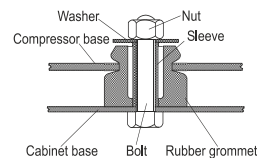

Snap-on

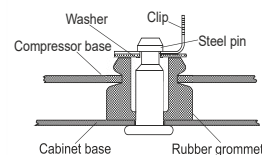

Mounting accessories

	order code
'4ZN' with rubber grommet	772N
'4ZN' with rubber grommet and sleeve for M6	768N
Bolt joint kit	4ZN + 118-1917 (18)
'4ZN' with Snap on kit	776N

Application notes

Provision for PE Grounding is located at the PE Stamp on the compressor

Housing with dip-tray fixture (omega bracket).

Various options of connectors are possible - please contact SECOP-Sales.

Model

Designation	HXK87AT	200-240V/50Hz	Conf. 1	Sales code:	16408900
-------------	----------------	----------------------	---------	-------------	-----------------

Configuration

Motorconfiguration	RSCR
Power supply (nominal)	200-240V/50Hz 1~
Refrigerant	R600a
Application	LBP
Voltage range	170-264V
Starting torque	LST
Approvals	VDE

Electrical accessories / wiring diagram

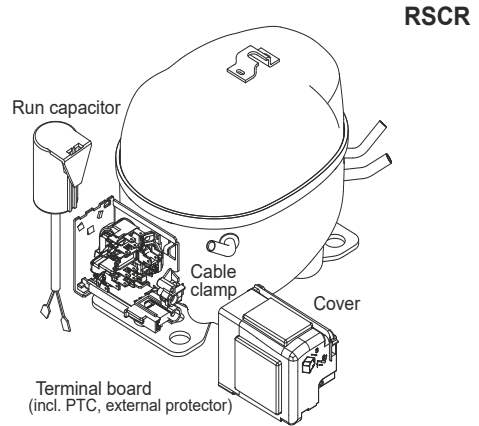

Ambient/ machine room temperatures minimum /maximum

Ambient temperature range:	10 - 43°C / 50 - 110°F
Machine room temperature range:	10 - 48°C / 50 - 119°F
Compressor cooling:	static

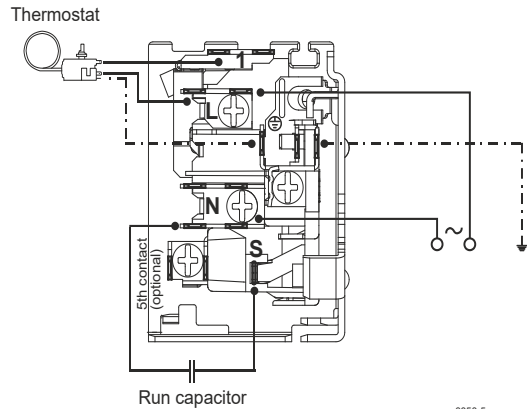

Operation pressure range

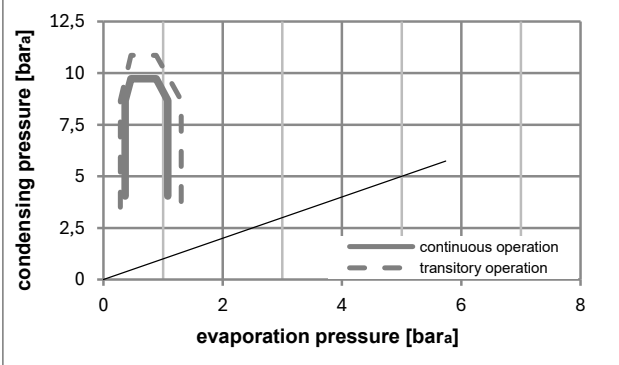
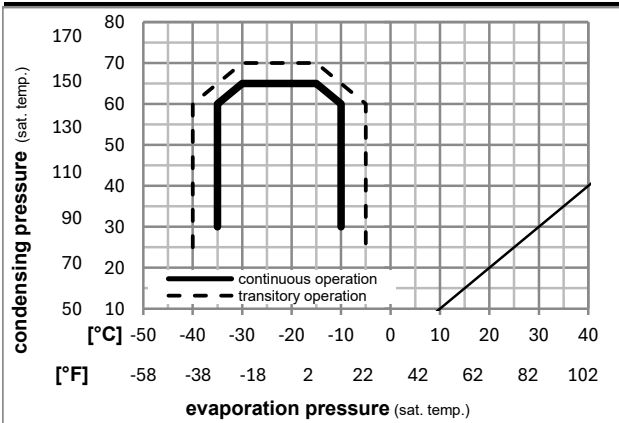

Components

. terminal board (PTC, 6.3mm)	16403700
. run capacitor (4μF, 6.3mm)	15186801
b cover terminal board	10636401
. cable clamp	11341000
. screw - uni6954	10636000
. screw - uni6954	10636200

Alternative components

. screw uni en iso 4757	10641201
-------------------------	----------

Model

Designation	HXK87AT	200-240V/50Hz	Conf. 1	Sales code:	16408900
-------------	----------------	----------------------	---------	-------------	-----------------

Optimization + standard conditions

R600a, 200V/50Hz, RSCR, static, VDE

Evaporating pressure (saturation temperature)				Condensing pressure (saturation temperature)			Power consumption					Ref. mass flow ṁ		
pe	pc	RGT	Tliq	Cooling capacity	COP	EER	P1	I						
[°C]	[°C]	[°C]	[°C]	[W]	[Btu/h]	[kcal/h]	[W/W]	[Btu/Wh]	[kcal/Wh]	[W]	[A]	[kg/h]		
[°C]	-23	54	32	32	153,8	525	132,3	1,75	5,97	1,50	88,0	0,45	1,65	ASHRAE LBP
[°F]	-10	130	90	90										
[°C]	-25	55	32	55	115,9	396	99,8	1,37	4,67	1,18	84,7	0,43	1,51	cecomaf LBP
[°F]	-13	131	90	131										
[°C]	-35	40	20	40	90,6	309	77,9	1,37	4,70	1,18	65,9	0,31	1,10	EN12900 LBP
[°F]	-31	104	68	104										
[°C]	-23	49	4,4	49	124,2	424	106,9	1,45	4,96	1,25	85,6	0,45	1,81	ARI540 LBP
[°F]	-10	120	40	120										
[°C]	-23	41	32	32	161,5	552	139,0	1,99	6,78	1,71	81,3	0,43	1,73	AHAM LBP
[°F]	-10	105	90	90										
[°C]	-35	45	32	45	87,9	300	75,7	1,31	4,48	1,13	67,1	0,29	1,04	opt
[°F]	-31	113	90	113										

Performance tables

R600a, 200V/50Hz, RSCR, static, VDE

	pe		Cooling capacity			COP	EER	P1	I	m	
	[°C]	[°F]	[W]	[Btu/h]	[kcal/h]	[W/W]	[Btu/Wh]	[kcal/Wh]	[W]	[A]	[kg/h]
[°C / °F]	-35	-31	87,9	300	75,7	1,31	4,48	1,13	67,1	0,29	1,04
cond. pressure	-30	-22	105,3	360	90,6	1,44	4,93	1,24	73,0	0,37	1,25
pc= 45/113	-25	-13	132,5	452	114,0	1,64	5,60	1,41	80,7	0,42	1,58
return gas temp.	-23	-10	143,8	491	123,8	1,72	5,87	1,48	83,7	0,44	1,71
RGT= 32/90	-20	-4	168,8	576	145,2	1,88	6,42	1,62	89,8	0,47	2,01
liquid temp	-15	5	213,5	729	183,7	2,14	7,31	1,84	99,8	0,51	2,55
Tliq= 45/113	-10	14	265,8	908	228,8	2,41	8,24	2,08	110,1	0,55	3,18
[°C / °F]	-35	-31	72,2	247	62,1	1,07	3,67	0,92	67,2	0,25	0,94
cond. pressure	-30	-22	90,1	308	77,6	1,20	4,10	1,03	75,1	0,36	1,17
pc= 55/131	-25	-13	115,9	396	99,8	1,37	4,67	1,18	84,7	0,43	1,51
return gas temp	-23	-10	126,3	432	108,7	1,43	4,89	1,23	88,3	0,46	1,65
RGT= 32/90	-20	-4	148,8	508	128,1	1,56	5,32	1,34	95,6	0,49	1,94
liquid temp	-15	5	188,2	643	162,0	1,76	6,00	1,51	107,2	0,55	2,46
Tliq= 55/131	-10	14	233,3	797	200,8	1,96	6,69	1,69	119,0	0,59	3,06

Model

Designation	HXK87AT	200-240V/50Hz	Conf. 2	Sales code:	16408900
-------------	----------------	----------------------	----------------	-------------	-----------------

Configuration

Electrical accessories / wiring diagram

Motorconfiguration	RSIR
Power supply (nominal)	200-240V/50Hz 1~
Refrigerant	R600a
Application	LBP
Voltage range	170-264V
Starting torque	LST
Approvals	VDE

Ambient/ machine room temperatures minimum /maximum

Ambient temperature range:	10 - 43°C / 50 - 110°F
Machine room temperature range:	10 - 48°C / 50 - 119°F
Compressor cooling:	static

Operation pressure range

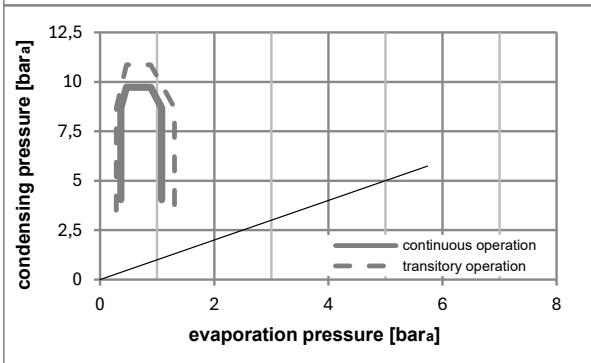
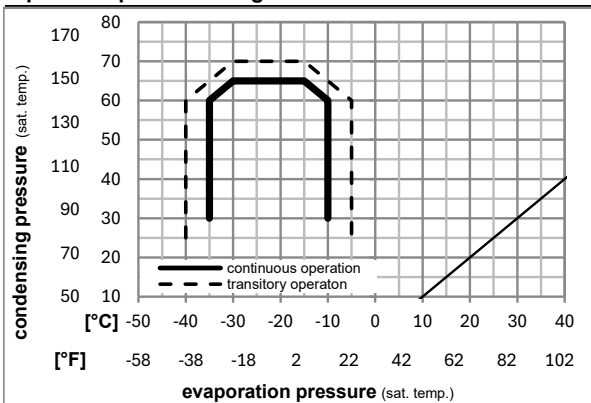

Components

.	terminal board (PTC, 6.3mm)	16403700
b	cover terminal board	10636401
.	cable clamp	11341000
.	screw - uni6954	10636000
.	screw - uni6954	10636200
.	screw uni en iso 4757	10641201

Model

Designation **HXK87AT** **220-240V/50Hz** Conf. 3 Sales code: **16408900**

Configuration

Motorconfiguration RSCR
 Power supply (nominal) 220-240V/50Hz 1~
 Refrigerant R600a
 Application LBP
 Voltage range 170-264V
 Starting torque LST
 Approvals VDE

Electrical accessories / wiring diagram

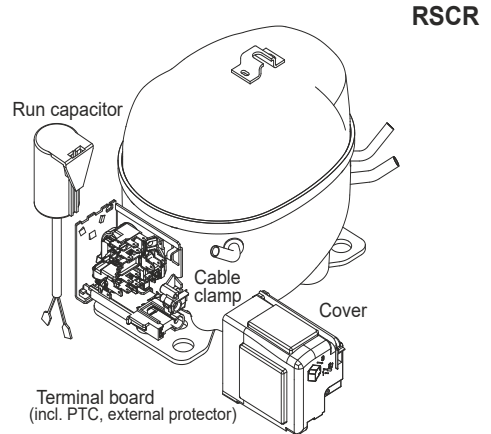

Ambient/ machine room temperatures minimum /maximum

Ambient temperature range: 10 - 43°C / 50 - 110°F
 Machine room temperature range: 10 - 48°C / 50 - 119°F
 Compressor cooling: static

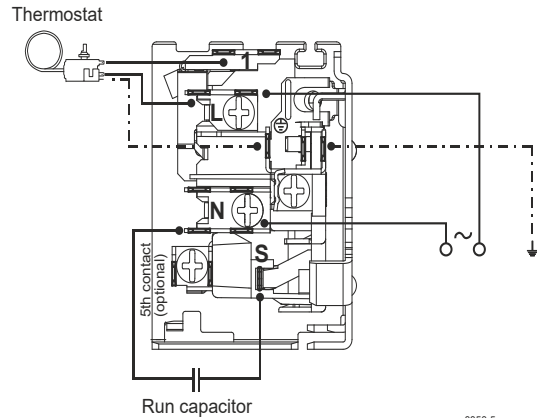

Operation pressure range

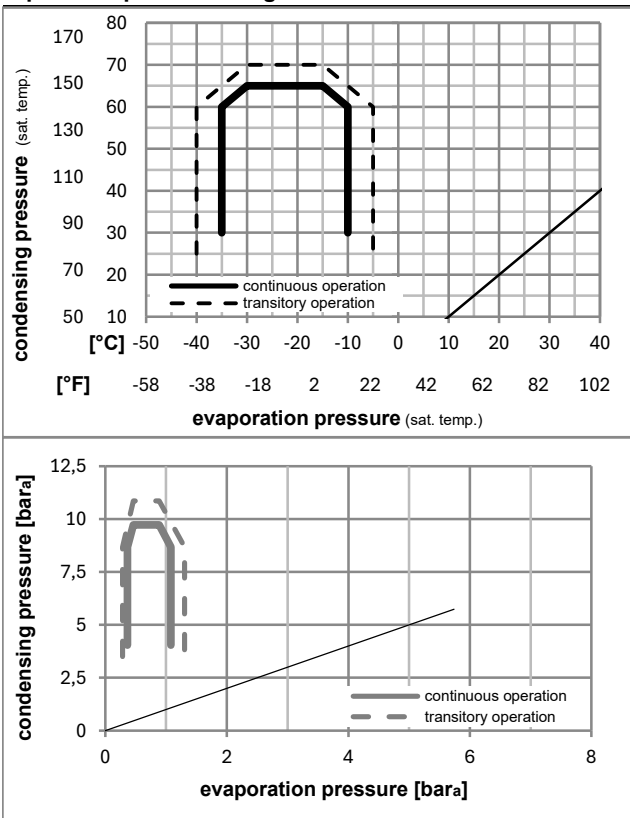

Components

- . terminal board (PTC, 6.3mm) 16403700
- . run capacitor (4μF, 6.3mm) 15186801
- b cover terminal board 10636401
- . cable clamp 11341000
- . screw - uni6954 10636000
- . screw - uni6954 10636200

Alternative components

- . screw uni en iso 4757 10641201

Model

Designation	HXK87AT	220-240V/50Hz	Conf. 3	Sales code:	16408900
-------------	----------------	----------------------	----------------	-------------	-----------------

Optimization + standard conditions

R600a, 220V/50Hz, RSCR, static, VDE

	Evaporating pressure (saturation temperature)				Condensing pressure (saturation temperature)			COP	EER	Power consumption			ASHRAE LBP	
	pe	pc	RGT	Tliq	[W]	[Btu/h]	[kcal/h]			P1	I	ṁ		
	[°C]	[°C]	[°C]	[°C]	[W]	[Btu/h]	[kcal/h]	[W/W]	[Btu/Wh]	[kcal/Wh]	[W]	[A]	[kg/h]	
	-23	54	32	32	154,9	529	133,3	1,71	5,84	1,47	90,5	0,47	1,66	ASHRAE LBP
	[°F]	-10	130	90										
	-25	55	32	55	116,7	399	100,5	1,34	4,58	1,15	87,1	0,45	1,52	cecomaf LBP
	[°F]	-13	131	90	131									
	-35	40	20	40	91,2	312	78,5	1,35	4,60	1,16	67,7	0,32	1,11	EN12900 LBP
	[°F]	-31	104	68	104									
	-23	49	4,4	49	125,1	427	107,7	1,42	4,85	1,22	88,0	0,46	1,83	ARI540 LBP
	[°F]	-10	120	40	120									
	-23	41	32	32	162,7	555	140,0	1,94	6,64	1,67	83,6	0,44	1,75	AHAM LBP
	[°F]	-10	105	90	90									
	-35	45	32	45	88,6	302	76,2	1,28	4,38	1,10	69,0	0,30	1,05	opt
	[°F]	-31	113	90	113									

Performance tables

R600a, 220V/50Hz, RSCR, static, VDE

	pe		Cooling capacity			COP	EER		P1	I	m
	[°C]	[°F]	[W]	[Btu/h]	[kcal/h]		[Btu/Wh]	[kcal/Wh]			
[°C / °F]	-35	-31	88,6	302	76,2	1,28	4,38	1,10	69,0	0,30	1,05
cond. pressure	-30	-22	106,0	362	91,3	1,41	4,83	1,22	75,0	0,38	1,26
pc= 45/113	-25	-13	133,4	456	114,8	1,61	5,49	1,38	83,0	0,44	1,59
return gas temp.	-23	-10	144,9	495	124,7	1,68	5,75	1,45	86,0	0,45	1,73
RGT= 32/90	-20	-4	170,0	580	146,3	1,84	6,29	1,58	92,3	0,48	2,03
liquid temp	-15	5	215,0	734	185,0	2,10	7,16	1,80	102,6	0,52	2,57
Tliq= 45/113	-10	14	267,7	914	230,4	2,36	8,08	2,04	113,2	0,57	3,21
[°C / °F]	-35	-31	72,7	248	62,6	1,05	3,59	0,91	69,1	0,26	0,95
cond. pressure	-30	-22	90,8	310	78,1	1,18	4,01	1,01	77,2	0,37	1,18
pc= 55/131	-25	-13	116,7	399	100,5	1,34	4,58	1,15	87,1	0,45	1,52
return gas temp	-23	-10	127,3	435	109,5	1,40	4,79	1,21	90,8	0,47	1,66
RGT= 32/90	-20	-4	149,9	512	129,0	1,53	5,21	1,31	98,3	0,51	1,96
liquid temp	-15	5	189,6	647	163,1	1,72	5,88	1,48	110,2	0,56	2,48
Tliq= 55/131	-10	14	235,0	802	202,2	1,92	6,56	1,65	122,4	0,61	3,08

Model

Designation	HXK87AT	208-230V/60Hz	Conf. 4	Sales code:	16408900
-------------	----------------	----------------------	----------------	-------------	-----------------

Configuration

Motorconfiguration	RSCR
Power supply (nominal)	208-230V/60Hz 1~
Refrigerant	R600a
Application	LBP
Voltage range	198-253V
Starting torque	LST
Approvals	VDE

Electrical accessories / wiring diagram

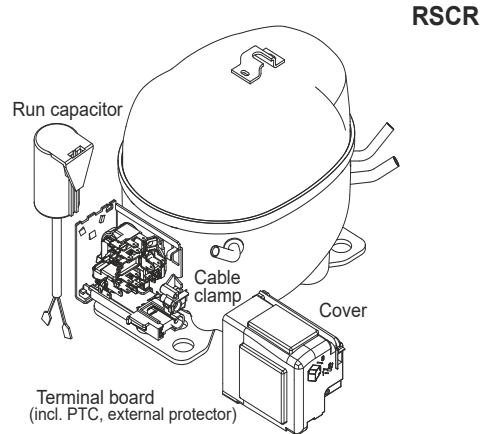

Ambient/ machine room temperatures minimum /maximum

Ambient temperature range:	10 - 43°C / 50 - 110°F
Machine room temperature range:	10 - 48°C / 50 - 119°F
Compressor cooling:	static

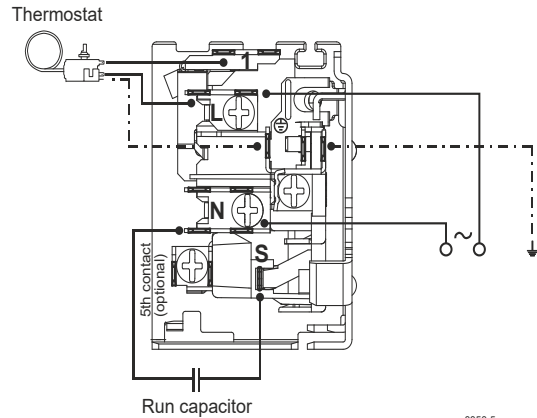

Operation pressure range

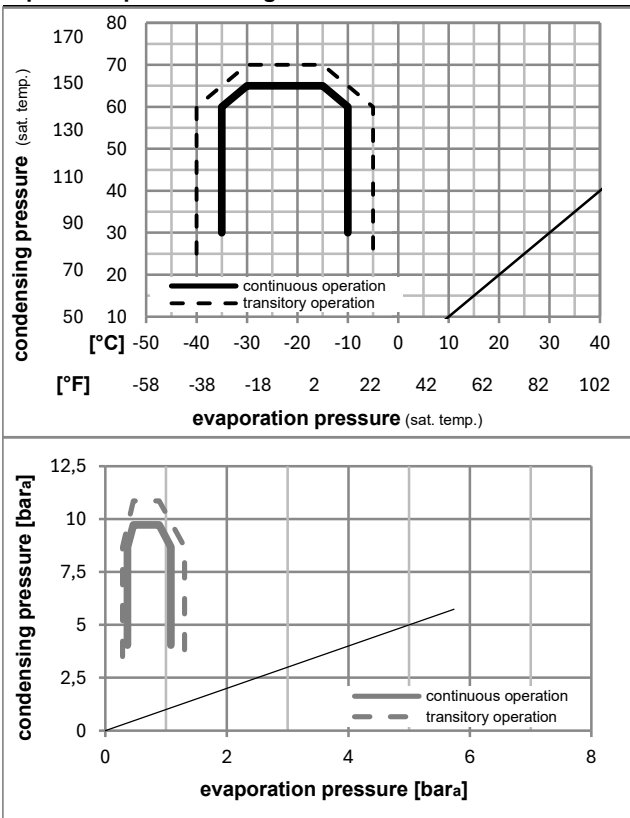

Components

. terminal board (PTC, 6.3mm)	16403700
. run capacitor (4μF, 6.3mm)	15186801
b cover terminal board	10636401
. cable clamp	11341000
. screw - uni6954	10636000
. screw - uni6954	10636200

Alternative components

. screw uni en iso 4757	10641201
-------------------------	----------



K-Series Compressors

GTK, HKK, HMK, HTK, HXK, HZK



Service/Repair – R600a



K-Series Compressors

GTK, HKK, HMK, HTK, HXK, HZK

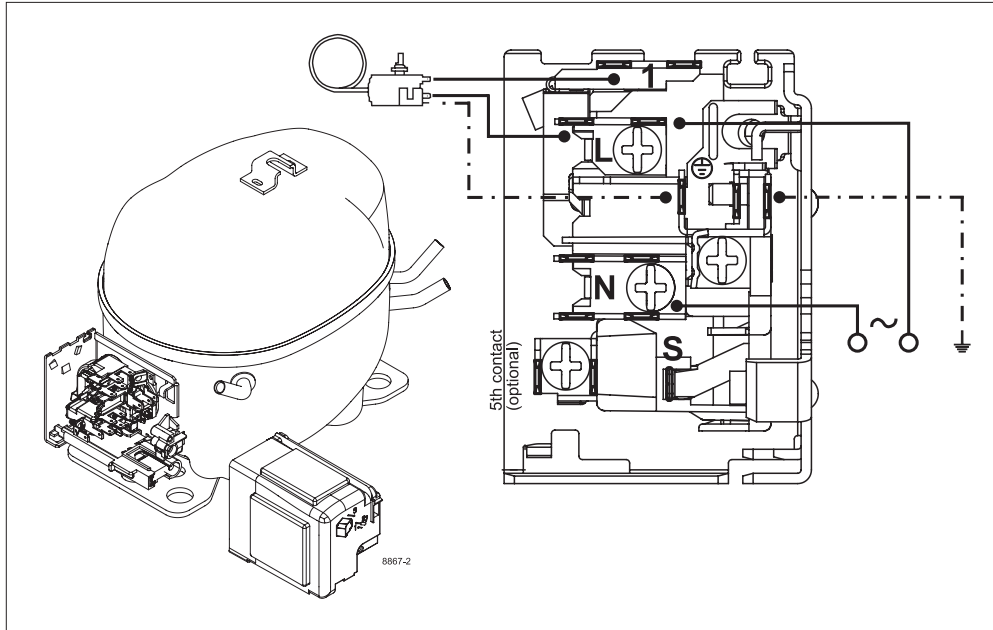

Service/Repair – R600a

Secop accepts no responsibility for possible errors in catalogs, brochures, and other printed material. Secop reserves the right to alter its products without notice. This also applies to products already on order provided that such alterations can be made without subsequential changes being necessary to specifications already agreed. All trademarks in this material are the property of the respective companies. Secop and the Secop logotype are trademarks of Secop GmbH. All rights reserved. www.secop.com